

SAP HANA System Replication Scale-Out - Multi-Target Performance-Optimized Scenario

SUSE Linux Enterprise Server for SAP Applications 15

Fabian Herschel, Distinguished Architect SAP (SUSE)
Sanjeet Kumar Jha, SAP Solution Architect - High Availability (SUSE)
Lars Pinne, System Engineer (SUSE)

SAP HANA System Replication Scale-Out - Multi-Target Performance-Optimized Scenario

Date: 2024-11-07

SUSE® Linux Enterprise Server for SAP Applications is optimized in various ways for SAP* applications. This guide provides detailed information about how to install and customize SUSE Linux Enterprise Server for SAP Applications for SAP HANA Scale-Out system replication automation in the performance optimized scenario and add a third site in a multi-target architecture. It is based on SUSE Linux Enterprise Server for SAP Applications 15 SP3. The concept however can also be used with SUSE Linux Enterprise Server for SAP Applications 15 SP1 or newer.

Disclaimer: Documents published as part of the SUSE Best Practices series have been contributed voluntarily by SUSE employees and third parties. They are meant to serve as examples of how particular actions can be performed. They have been compiled with utmost attention to detail. However, this does not guarantee complete accuracy. SUSE cannot verify that actions described in these documents do what is claimed or whether actions described have unintended consequences. SUSE LLC, its affiliates, the authors, and the translators may not be held liable for possible errors or the consequences thereof.

Contents

- 1 About this guide 4
- 2 Scope of this documentation 6
- 3 Planning the installation 8
- 4 Setting up the operating system 19
- 5 Installing the SAP HANA databases on both sites 27
- 6 Setting up SAP HANA system replication 32
- 7 Integrating SAP HANA with the Linux cluster 37
- 8 Configuring the cluster and SAP HANA resources 44
- 9 Setup of a scale-out multi-target architecture 58
- 10 Testing the cluster 63
- 11 Administration 68
- 12 References 76
- 13 Legal notice 87
- 14 GNU Free Documentation License 88

1 About this guide

1.1 Introduction

SUSE® Linux Enterprise Server for SAP Applications is optimized in various ways for SAP* applications. This guide provides detailed information about installing and customizing *SUSE Linux Enterprise Server for SAP Applications* for SAP HANA scale-out system replication in a multi-target architecture. The automation of system replication between SAP HANA first site to SAP HANA second site is managed by SUSE Linux Enterprise Server for SAP Applications while there is an additional system replication to a third site outside the scope of automation by SUSE Linux Enterprise Server for SAP Applications.

High availability is an important aspect of running your mission-critical SAP HANA servers.

The SAP HANA scale-out multi-target system replication is a replication of all data in SAP HANA to a second SAP HANA system in a SYNC replication. To a third SAP HANA system usually it is an ASYNC replication. The SAP HANA itself replicates all of its data to secondary SAP HANA instances. It is an out-of-the-box, standard feature.

The recovery time objective (RTO) is minimized through the data replication at regular intervals. SAP HANA supports asynchronous and synchronous modes. The document at hand describes the synchronous replication from memory into memory of the second system. This is the only method that allows the cluster to make a decision based on coded algorithms.

1.2 Abstract

This guide describes planning, setup, and basic testing of SUSE Linux Enterprise Server for SAP Applications 15 for an "SAP HANA Scale-Out Multi-Target System Replication - ERP style" scenario.

From the application perspective the following variants are covered:

- Plain system replication
- Multi-tier (chained) system replication
- Multi-target system replication
- Multi-tenant database containers for all above

- Active/active read enabled for all of the above
- HANA host auto-failover is not used, there is only one master name server configured and no candidates
- HANA host auto-failover is restricted and not explained in this guide

From the infrastructure perspective the following variants are covered:

- 3-site cluster with disk-based SBD fencing and a 4th non-cluster site (replication [A ⇒ B] → C)
- 1-site cluster with disk-based SBD fencing and a 2nd non-cluster site is possible, but not explained in this guide
- Other fencing is possible, but not explained here
- On-premises deployment on physical and virtual machines
- Public cloud deployment (usually needs additional documentation on cloud specific details)

Deployment automation simplifies roll-out. There are several options available, particularly on public cloud platforms. Ask your public cloud provider or your SUSE contact for details.



Note



In this guide the software package SAPHanaSR-ScaleOut is used. This package has been obsoleted by SAPHanaSR-angi. Thus new deployment should be done with SAPHanaSR-angi only, following the setup guide at <https://documentation.suse.com/sbp/sap-15/html/SLES4SAP-hana-angi-scaleout-perfopt-15/index.html> . For upgrading existing clusters to SAPHanaSR-angi, please read the blog article <https://www.suse.com/c/how-to-upgrade-to-saphanasr-angi/> .

1.3 Additional documentation and resources

Chapters in this manual contain links to additional documentation resources that are either available on the system or on the Internet.

For the latest SUSE product documentation updates, see <https://documentation.suse.com> .

Find white-papers, best-practices guides, and other resources at the

- SUSE Linux Enterprise Server for SAP Applications resource library: <https://documentation.suse.com/sbp/sap/> 
- SUSE Best Practices Web page: <https://documentation.suse.com/sbp/sap/> 
- Supported high availability solutions by SUSE Linux Enterprise Server for SAP Applications overview: <https://documentation.suse.com/sles-sap/sap-ha-support/html/sap-ha-support/article-sap-ha-support.html> 

Lastly, there are manual pages shipped with the product.

1.4 Feedback

Several feedback channels are available:

Bugs and Enhancement Requests

For services and support options available for your product, refer to <http://www.suse.com/support/> .

To report bugs for a product component, go to <https://scc.suse.com/support/>  requests, log in, and select *Submit New SR* (Service Request).

Mail

For feedback on the documentation of this product, you can send a mail to doc-team@suse.com (<mailto:doc-team@suse.com>) . Make sure to include the document title, the product version and the publication date of the documentation. To report errors or suggest enhancements, provide a concise description of the problem and refer to the respective section number and page (or URL).

2 Scope of this documentation

This document describes how to set up SAP HANA scale-out multi-target system replication with a cluster installed on two sites (and a third site which acts as majority maker) based on SUSE Linux Enterprise Server for SAP Applications 15 SP4. Furthermore, it describes how to add an additional non-cluster site for a multi-target architecture. This concept can also be used with SUSE Linux Enterprise Server for SAP Applications 15 SP1 or newer.

For a better understanding and overview, the installation and setup is subdivided into seven steps.

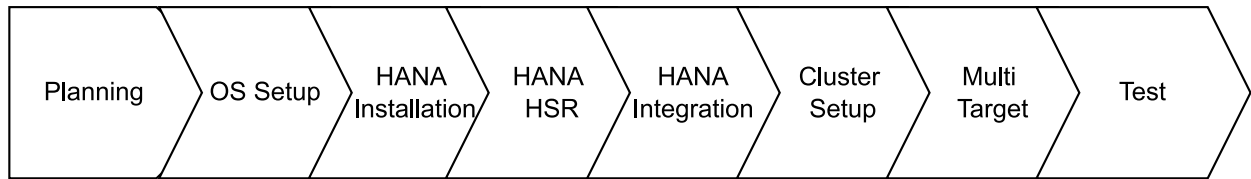

FIGURE 1: SECTION 3, “PLANNING THE INSTALLATION” (PAGE 9) [OSSETUP] [SAPHANAINST] [SAPHANAHSR] SECTION 7, “INTEGRATING SAP HANA WITH THE LINUX CLUSTER” (PAGE 37) SECTION 8, “CONFIGURING THE CLUSTER AND SAP HANA RESOURCES” (PAGE 44) SECTION 9, “SETUP OF A SCALE-OUT MULTI-TARGET ARCHITECTURE” (PAGE 58) [TESTING]

- Planning (section *Section 3, “Planning the installation”* (page 9))
- OS setup (section [OsSetup])
- SAP HANA installation (section [SAPHanaInst])
- SAP HANA system replication configuration (section [SAPHanaHsr])
- SAP HANA cluster integration (section *Section 7, “Integrating SAP HANA with the Linux cluster”* (page 37))
- SLES for SAP cluster configuration (section *Section 8, “Configuring the cluster and SAP HANA resources”* (page 44))
- Setup of third SAP HANA site in a multi-target architecture (section *Section 9, “Setup of a scale-out multi-target architecture”* (page 58))
- Testing (section [Testing])

First, we will set up a SUSE Linux Enterprise Server for SAP Applications cluster controlling two sites of SAP HANA scale-out in a system replication configuration. Next, we will set up a third site which is outside the SUSE Linux Enterprise High Availability Extension cluster but acts as additional SAP HANA target, forming a multi-target architecture.

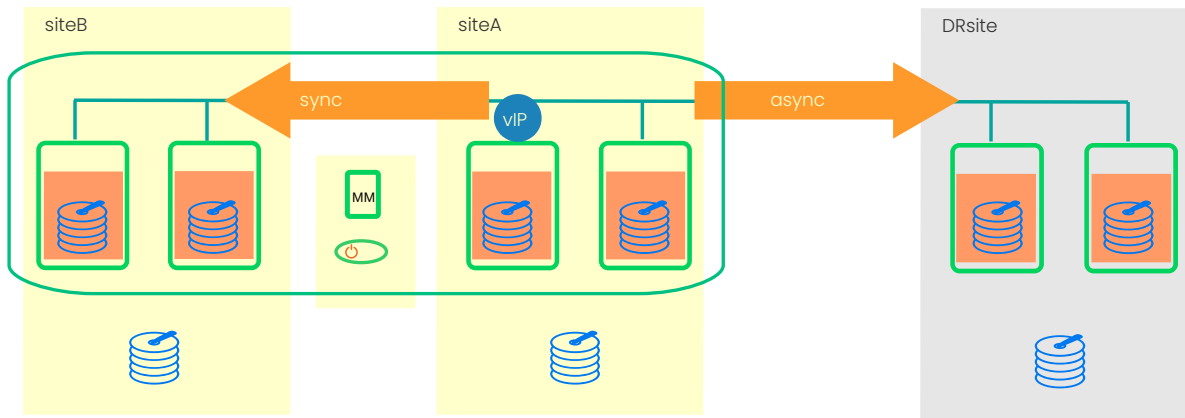

FIGURE 2: CLUSTER WITH SAP HANA MULTI-TARGET SR - PERFORMANCE OPTIMIZED

With SAPHanaSR-ScaleOut, various SAP HANA scale-out configurations are supported. Details on requirements and supported scenarios are given below.

In this guide we will cover a scale-out scenario without standby nodes, thus there is no host auto-failover. More details are explained at <https://www.suse.com/c/sap-hana-scale-out-system-replication-for-large-erp-systems/> . The scenario where SAP HANA is configured for host auto-failover is explained at <https://documentation.suse.com/sbp/all/html/SLES4SAP-hana-scale-Out-PerfOpt-15/index.html> .



Note

For upgrading an existing SAP HANA scale-out system replication cluster from SAPHanaSR-ScaleOut version 0.160, consult manual page SAPHanaSR-manageAttr(8) and the blog article <https://www.suse.com/c/sap-hana-scale-out-multi-target-upgrade/> .

3 Planning the installation

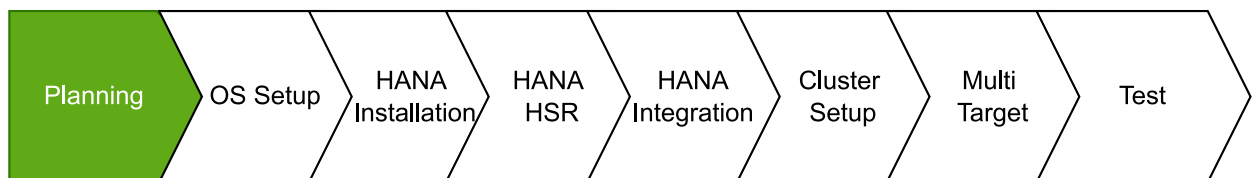

FIGURE 3: PLANNING [OSSETUP] [SAPHANAINST] [SAPHANAHSR] SECTION 7, "INTEGRATING SAP HANA WITH THE LINUX CLUSTER" (PAGE 37) SECTION 8, "CONFIGURING THE CLUSTER AND SAP HANA RESOURCES" (PAGE 44) SECTION 9, "SETUP OF A SCALE-OUT MULTI-TARGET ARCHITECTURE" (PAGE 58) [TESTING]

Planning the installation is essential for a successful SAP HANA cluster setup.

What you need before you start:

- Software from SUSE: SUSE Linux Enterprise Server for SAP Applications installation media and a valid subscription for getting updates
- Software from SAP: SAP HANA installation media
- Physical or virtual systems including disks and NFS storage pools (see below)
- Filled parameter sheet (see below)

3.1 Minimum lab requirements and prerequisites

This section defines some minimum requirements to install SAP HANA scale-out multi-target in ERP style.

From SAP HANA perspective we have three sites with two nodes each. Each site has one NFS service providing three shares to the two nodes. The NFS services must **not** be stretched across sites. The /hana/shared/ needs to be shared across the two nodes. The /hana/data/ and /hana/log/ are on NFS and provided to both nodes, for simplicity. However, instead this two shares could be placed on the nodes locally, both file systems at each node.



Note

Refer to SAP HANA TDI documentation for allowed storage configuration and file systems.

From Linux cluster perspective we have three sites. Two of the cluster sites are hosting the workload. The third cluster site is for the majority maker node. HANA file systems and NFS shares are not managed by the Linux cluster.

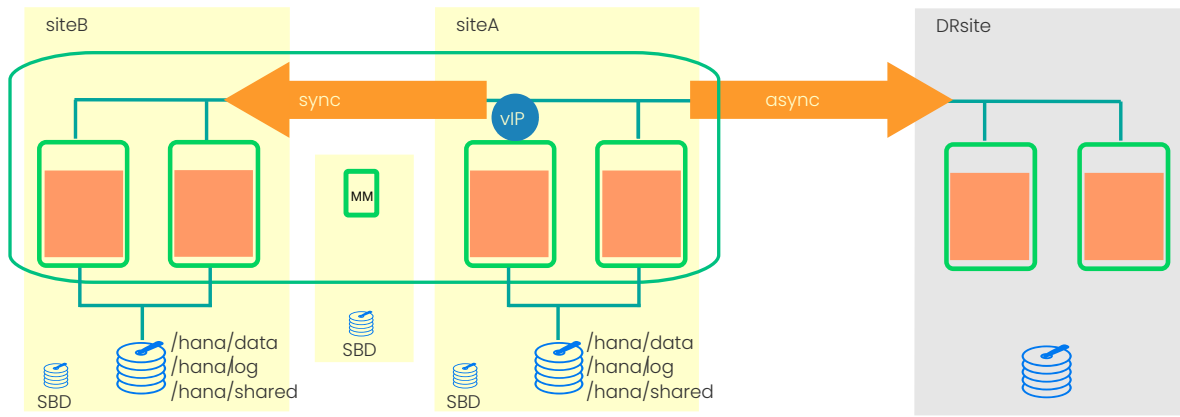

FIGURE 4: SIMPLIFIED NFS STRUCTURE OF AN SAP HANA MULTI-TARGET SYSTEM REPLICATION CLUSTER

The SBD based fencing needs up to three block devices. They are shared across the three cluster sites and accessed by all five cluster nodes. One block device for SBD might be an iSCSI target placed at the cluster third site. The SBD block devices are backed by storage outside the cluster.

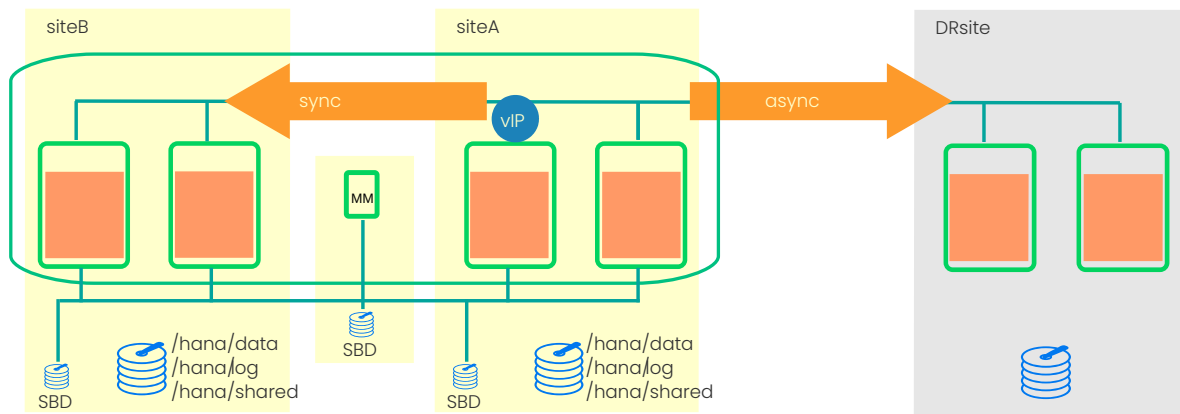

FIGURE 5: SIMPLIFIED SBD STRUCTURE OF AN SAP HANA MULTI-TARGET SYSTEM REPLICATION CLUSTER

Requirements with 2 SAP HANA instances per site (aka [2+0 ⇐ 2+0] → 2+0) plus the majority maker:

- 6 VMs with each 32 GB RAM, 50 GB disk space
- 1 VM with 2 GB RAM, 50 GB disk space
- 1 shared disk for SBD with 10 MB disk space
- 3 NFS pools (one per site) with a capacity of each 120 GB

- 1 additional IP address for takeover
- optional: 2nd additional IP address for active/read-enabled setup



Note

The minimum lab requirements mentioned here are no SAP sizing information. These data are provided only to rebuild the described cluster in a lab for test purposes. Even for such tests the requirements can increase depending on your test scenario. For productive systems ask your hardware vendor or use the official SAP sizing tools and services.

3.2 Parameter sheet

The multi-target architecture with a cluster organizing two SAP HANA sites and a third site is quite complex. The installation should be planned properly. You should have all needed parameters like SID, IP addresses and much more already in place. It is a good practice to first fill out the parameter sheet and then begin with the installation.

TABLE 1: PARAMETER SHEET TO PREPARE THE NFS BASED SETUP

Parameter	Value
Path to SLES for SAP media	
RMT server or SCC account	
NTP server(s)	
Path to SAP HANA media	
S-User for SAP marketplace	
Node 1 name site 1	
Node 2 name site 1	
Node 1 name site 2	
Node 2 name site 2	
Node 1 name site 3	

Parameter	Value
Node 2 name site 3	
Node name majority maker (site 3 or 4)	
IP addresses of all cluster nodes	
SID	
Instance number	
Service IP address	
Service IP address active/read-enabled	
HANA site name site 1	
HANA site name site 2	
HANA site name site 3	
NFS server site 1	
NFS share "shared" site 1	
NFS share "data" site 1	
NFS share "log" site 1	
NFS server site 2	
NFS share "shared" site 2	
NFS share "data" site 2	
NFS share "log" site 2	
NFS server site 3	

Parameter	Value
NFS share "shared" site 3	
NFS share "data" site 3	
NFS share "log" site 3	
SBD STONITH block device(s)	
Watchdog driver	

3.3 Scale-out scenario and HA resource agents

To automate the failover of SAP HANA database and virtual IP resource between the first 2 sites in a scale-out multi-target setup, the High Availability Extension built into *SUSE Linux Enterprise Server for SAP Applications* is used. Two resource agents have been created to handle the scenario. The first is the **SAPHanaController** resource agent (RA), which checks and manages the SAP HANA database instances. This RA is configured as a multi-state resource.

The master assumes responsibility for the active master name server of the SAP HANA database running in primary mode. All other instances are represented by the slave mode.

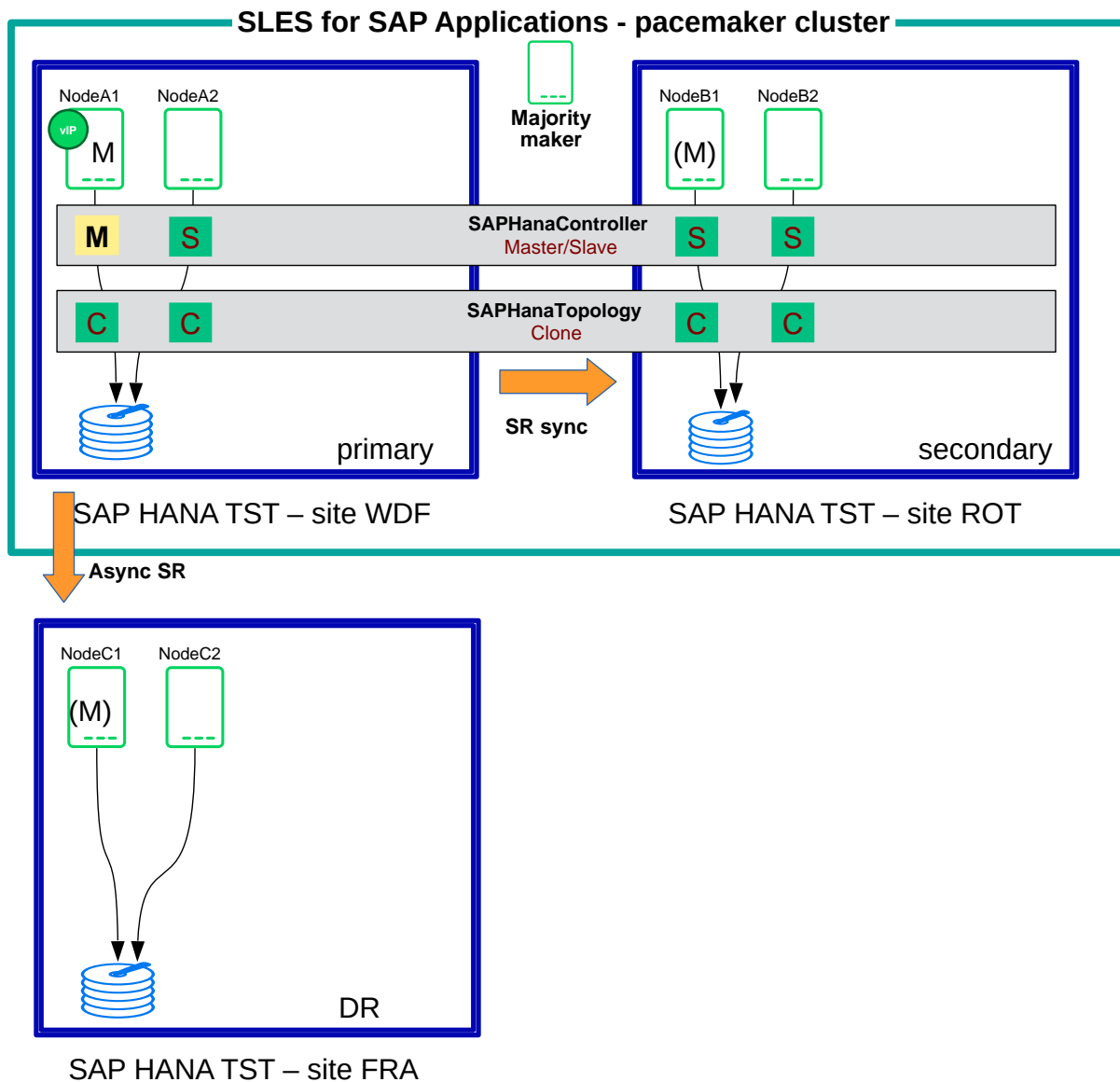

FIGURE 6: CLUSTER RESOURCE AGENTS AND MULTI-STATE STATUS MAPPING

The second resource agent is **SAPHanaTopology**. This RA has been created to make configuring the cluster as simple as possible. It runs on all nodes (except the majority maker) of a SUSE Linux Enterprise High Availability Extension 15 cluster. It gathers information about the statuses and configurations of the SAP HANA system replication. It is designed as a normal (stateless) clone resource.

With the current version of resource agents, SAP HANA system replication for scale-out is supported in the following scenarios or use cases:

Performance optimized, single container ([A => B])

In the performance optimized scenario an SAP HANA RDBMS on site "A" is synchronizing with an SAP HANA RDBMS on a second site "B". As the SAP HANA RDBMS on the second site is configured to preload the tables the takeover time is typically very short. See also the requirements section below for details.

Performance optimized, multi-tenancy also named MDC ([%A => %B])

Multi-tenancy is available for all of the supported scenarios and use cases in this document. This scenario is the default installation type for SAP HANA 2.0. The setup and configuration from a cluster point of view is the same for multi-tenancy and single containers. The one caveat is, that the tenants are managed all together by the Linux cluster. See also the requirements section below.

Multi-Tier Replication ([A => B] -> C)

A Multi-Tier system replication has an additional target, which must be connected to the secondary (chain topology). This is a special case of the Multi-Target replication. Because of the mandatory chain topology, the RA feature `AUTOMATED_REGISTER = true` is not possible with pure Multi-Tier replication. See also the requirements section below.

Multi-Target Replication ([A <= B] -> C)

This scenario and setup is described in this document. A Multi-Target system replication has an additional target, which is connected to either the secondary (chain topology) or to the primary (star topology). Multi-Target replication is possible since SAP HANA 2.0 SPS04. See also the requirements section below.

3.4 The concept of the multi-target scenario

A multi-target scenario consists of 3 sites. Site 1 and site 2 are in HA cluster while site 3 is outside the HA cluster.

In case of failure of the primary SAP HANA on site 1 the cluster first tries to start the takeover process. This allows to use the already loaded data at the secondary site. Typically the takeover is much faster than the local restart.

A site is noticed as "down" or "on error", if the **LandscapeHostConfiguration status** reflects this (return code 1). This happens when worker nodes are going down without any SAP HANA standby nodes left. ERP-style SAP HANA scale-out database will have no standby nodes by design. Find more details on concept and implementation in manual page `SAPHanaSR-ScaleOut(7)`. To achieve an automation of this resource handling process, use the SAP HANA resource agents included in the `SAPHanaSR-ScaleOut` RPM package delivered with SUSE Linux Enterprise Server for SAP Applications.

You can configure the level of automation by setting the parameter `AUTOMATED_REGISTER`. If automated registration is activated the cluster will also automatically register a former failed primary to get the new secondary. Find configuration details in manual page `ocf_suse_SAPHana-Controller(7)`.

The resource agent for HANA in a Linux cluster does not trigger a takeover to the secondary site when a software failure causes one or more HANA processes to be restarted. The same is valid when a hardware error causes the index server to restart locally. Therefore the `SAPHanaSR-ScaleOut` package contains the HA/DR provider hook script `susChkSrv.py`. For details see manual page `susChkSrv.py(7)`.

Site 3 is connected as an additional system replication target to either SAP HANA site inside the cluster. That two HANA sites need to be configured for automatically re-registering the 3rd site in case of takeover.

3.5 Important prerequisites

Read the SAP Notes and papers first.

The `SAPHanaSR-ScaleOut` resource agent software package supports scale-out (multiple-box to multiple-box) system replication with the following configurations and parameters:

- The cluster must include a valid STONITH method. SBD disk-based is the recommended STONITH method.
- Both cluster controlled SAP HANA sites are either in the same network segment (layer 2) to allow an easy takeover of an IP Address, or you need a technique like overlay IP addresses in virtual private clouds.
- Technical users and groups, such as `<sid>adm` are defined **locally** in the Linux system.
- Name resolution of the cluster nodes and the virtual IP address should be done **locally** on **all** cluster nodes to not depend on DNS services (as it can fail, too).

- Time synchronization between the cluster nodes using reliable time services like NTP.
- All SAP HANA sites have the same SAP Identifier (SID) and instance number.
- The SAP HANA scale-out system must have only **one** active master name server per site. There are no configured master name server.
- For SAP HANA databases without additional master name server candidate, the package SAPHanaSR-ScaleOut version 0.180 or newer is needed.
- The SAP HANA scale-out system must have only **one** failover group.
- There is maximum one additional SAP HANA system replication connected from outside the Linux cluster. Thus two sites are managed by the Linux cluster, one site outside is recognized. For SAP HANA multi-tier and multi-target system replication, the package SAPHanaSR-ScaleOut version 0.180 or newer is needed.
- Only one SAP HANA SID is installed. Thus the performance optimized setup is supported. The cost optimized and MCOS scenarios are currently not supported.
- The *saphostagent* must be running. *saphostagent* is needed to translate between the system node names and SAP host names used during the installation of SAP HANA.
 - For SystemV style, the *sapinit* script needs to be active.
 - For systemd style, the services *saphostagent* and *SAP<SID>_<INO>* can stay enabled. The systemd enabled *saphostagent* and instance's *sapstartsrv* is supported from SAPHanaSR-ScaleOut 0.181 onwards. Refer to the OS documentation for the systemd version. SAP HANA comes with native systemd integration as default starting with version 2.0 SPS07. Refer to SAP documentation for the SAP HANA version.
 - Combining systemd style *hostagent* with SystemV style instance is allowed. However, all nodes in one Linux cluster have to use the same style.
- All SAP HANA instances controlled by the cluster must not be activated via *sapinit* auto-start.
- Automated start of SAP HANA instances during system boot must be switched **off**.
- The replication mode should be either 'sync' or 'syncmem'. 'async' is supported outside the Linux cluster.

- SAP HANA 2.0 SPS05 rev.059 and later provides Python 3 as well as the HA/DR provider hook method `srConnectionChanged()` with needed parameters for `SAPHanaSrMultiTarget.py`.
- SAP HANA 2.0 SPS05 or later provides the HA/DR provider hook method `srServiceStateChanged()` with needed parameters for `susChkSrv.py`.
- SAP HANA 2.0 SPS06 or later provides the HA/DR provider hook method `preTakeover()` with multi-target aware parameters and separate return code for Linux HA clusters.
- No other HA/DR provider hook script should be configured for the above mentioned methods. Hook scripts for other methods, provided in `SAPHanaSR-ScaleOut`, can be used in parallel, if not documented contradictingly.
- The Linux cluster needs to be up and running to allow HA/DR provider events being written into CIB attributes. The current HANA SR status might differ from CIB `srHook` attribute after Linux cluster maintenance.
- The user `<sid>adm` needs execution permission as user root for the command `SAPHanaSR-hookHelper`.
- For optimal automation, `AUTOMATED_REGISTER = "true"` is recommended.

Important

As good starting configuration for projects, it is recommended to **switch off** the automated registration of a failed primary, therefore `AUTOMATED_REGISTER="false"` is the **default**.

In this case, you need to register a failed primary after a takeover manually. Use SAP tools like SAP HANA Cockpit or `hdbnsutil`. Make sure to use always the exact site names as already known to the cluster.

The two SAP HANA sites inside the Linux cluster can be configured to re-register the outer SAP HANA in case of takeover. For this a configuration item `'register_secondaries_on_takeover = true'` needs to be added in the `system_replication` block of the `global.ini` file. See also manual page `SAPHanaSrMultiTarget.py(7)`.

- You need at least SAPHanaSR-ScaleOut version 0.184, SUSE Linux Enterprise Server for SAP Applications 15 SP1 and SAP HANA 2.0 SPS 05 for all mentioned setups.
- The Linux cluster can be either freshly installed as described in this guide, or it can be upgraded as described in respective documentation. Not allowed is mixing old and new cluster attributes or hook scripts within one cluster.
- No manual actions must be performed on the SAP HANA database while it is controlled by the Linux cluster. All administrative actions need to be aligned with the cluster.

Find more details in the REQUIREMENTS section of manual pages SAPHanaSR-ScaleOut(7), ocf_suse_SAPHanaController(7), SAPHanaSrMultiTarget.py(7), SAPHanaSR-manageAttr(8), susChkSrv.py(7) and susTkOver.py(7).

! Important

You must implement a valid STONITH method. Without a valid STONITH method, the complete cluster is unsupported and will not work properly.

In this setup guide, NFS is used as storage for the SAP HANA database. This has been chosen for simplicity. However, any storage supported by SAP HANA and the SAP HANA storage API can be used. Refer to the SAP HANA TDI documentation for supported storage and follow the respective storage vendor's configuration instructions.

This setup guide focuses on the scale-out multi-target setup.

If you need to implement a different scenario, it is strongly recommended to define a Proof-of-Concept (PoC) with SUSE. This PoC will focus on testing the existing solution in your scenario. The limitation of most of the above items is mostly because of testing limits.

4 Setting up the operating system

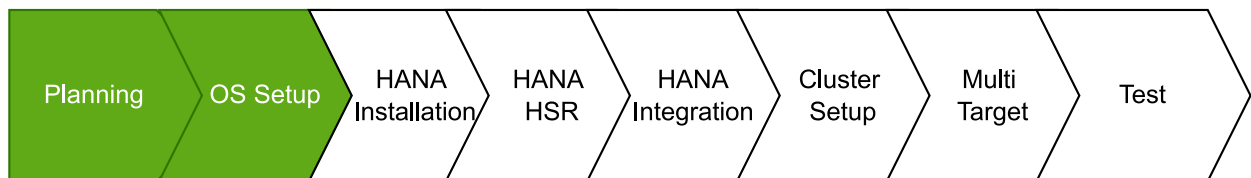

FIGURE 7: SECTION 3, "PLANNING THE INSTALLATION" (PAGE 9) OSSETUP [SAPHANAINST] [SAPHANAHSR] SECTION 7, "INTEGRATING SAP HANA WITH THE LINUX CLUSTER" (PAGE 37) SECTION 8, "CONFIGURING THE CLUSTER AND SAP HANA RESOURCES" (PAGE 44) SECTION 9, "SETUP OF A SCALE-OUT MULTI-TARGET ARCHITECTURE" (PAGE 58) [TESTING]

This section includes information you should consider during the installation of the operating system.

In this document, first SUSE Linux Enterprise Server for SAP Applications is installed and configured. Then the SAP HANA database including the system replication is set up. Next, the automation with the cluster is set up and configured. Finally, the multi-target setup of the 3rd site is set up and configured.

4.1 Installing SUSE Linux Enterprise Server for SAP Applications

Multiple installation guides are already existing, with different reasons to set up the server in a certain way. Below it is outlined where this information can be found. In addition, you will find important details you should consider to get a system which is well prepared to deliver SAP HANA.

4.1.1 Installing the base operating system

Depending on your infrastructure and the hardware used, you need to adapt the installation. All supported installation methods and minimum requirement are described in the *Deployment Guide* (<https://documentation.suse.com/sles/15-SP4/single-html/SLES-deployment/#book-deployment>). In case of automated installations you can find further information in the *AutoYaST Guide* (<https://documentation.suse.com/sles/15-SP4/single-html/SLES-automast/#book-automast>). The major installation guide for SUSE Linux Enterprise Server for SAP Applications to fit all requirements for SAP HANA is described in the SAP notes:

- 2578899 SUSE Linux Enterprise Server 15: Installation Note and
- 2684254 SAP HANA DB: Recommended OS settings for SLES 15 / SLES for SAP Applications 15

4.1.2 Installing additional software

SUSE delivers with SUSE Linux Enterprise Server for SAP Applications special resource agents for SAP HANA. With the pattern *sap-hana* the resource agent for SAP HANA **ScaleUp** is installed. For the **ScaleOut** scenario you need a special resource agent. Follow the instructions below on each node if you have installed the systems based on SAP note 2684254. The pattern *High Availability* summarizes all tools recommended to be installed on **all** nodes, including the *majority maker*.

- remove package: patterns-sap-hana, SAPHanaSR, yast2-sap-ha
- install package: SAPHanaSR-ScaleOut, SAPHanaSR-ScaleOut-doc, ClusterTools2, saptune
- install pattern: ha_sles

To do so, for example, use Zypper:

EXAMPLE 1: UNINSTALL THE SAPHANASR AGENT FOR SCALE-UP

As user_root_ , type:

```
# zypper remove SAPHanaSR
```

If the package is installed, you will get an output like this:

```
Loading repository data...
Reading installed packages...
Resolving package dependencies...

The following 3 packages are going to be REMOVED:
  patterns-sap-hana SAPHanaSR yast2-sap-ha

The following pattern is going to be REMOVED:
  sap-hana

3 packages to remove.
After the operation, 494.2 KiB will be freed.
Continue? [y/n/...? shows all options] (y): y
(1/3) Removing patterns-sap-hana-15.3-6.8.2.x86_64 .....
[done]
(2/3) Removing yast2-sap-ha-1.0.0-2.5.12.noarch .....
[done]
(3/3) Removing SAPHanaSR-0.161.21-1.1.noarch .....
[done]
```

EXAMPLE 2: INSTALLATION OF THE SAPHANASR AGENT FOR SCALE-OUT

As user root, type:

```
# zypper in SAPHanaSR-ScaleOut SAPHanaSR-ScaleOut-doc
```

If the package is not installed yet, you should get an output like the below:

```
Refreshing service 'Advanced_Systems_Management_Module_15_x86_64'.
Refreshing service
'SUSE_Linux_Enterprise_Server_for_SAP_Applications_15_SP3_x86_64'.
Loading repository data...
Reading installed packages...
Resolving package dependencies...
```

```

The following 2 NEW packages are going to be installed:
  SAPHanaSR-ScaleOut SAPHanaSR-ScaleOut-doc

2 new packages to install.
Overall download size: 539.1 KiB. Already cached: 0 B. After the operation,
additional 763.1 KiB will be used.
Continue? [y/n/...? shows all options] (y): y
Retrieving package SAPHanaSR-ScaleOut-0.180.1-1.1.noarch           (1/2),
 48.7 KiB (211.8 KiB unpacked)
Retrieving: SAPHanaSR-
ScaleOut-0.180.1-1.1.noarch.rpm .....[done]
Retrieving package SAPHanaSR-ScaleOut-doc-0.180.1-1.1.noarch     (2/2),
 490.4 KiB (551.3 KiB unpacked)
Retrieving: SAPHanaSR-ScaleOut-
doc-0.180.1-1.1.noarch.rpm .....[done (48.0 KiB/s)]
Checking for file
  conflicts: .....[done]
(1/2) Installing: SAPHanaSR-
ScaleOut-0.180.1-1.1.noarch .....[done]
(2/2) Installing: SAPHanaSR-ScaleOut-
doc-0.180.1-1.1.noarch .....[done]

```

Install the tools for High Availability on all nodes.

```
# zypper in --type pattern ha_sles
```

4.1.3 Getting the latest updates

If you have installed the packages before, make sure to deploy the newest updates on all machines to have the latest versions of the resource agents and other packages. Also, make sure all systems have identical package versions. A prerequisite is a valid subscription for SUSE Linux Enterprise Server for SAP Applications. There are multiple ways to get updates via SUSE Manager, the Repository Management Tool (RMT), or via a direct connection to the SUSE Customer Center (SCC).

Depending on your company or customer rules, use `zypper update` or `zypper patch`.

EXAMPLE 3: SOFTWARE UPDATE MUST BE TRIGGERED FROM EACH NODE

The command `zypper patch` will install all available needed patches. As user root, type:

```
# zypper patch
```

The command `zypper update` will update all or specified installed packages with newer versions, if possible. As user root, type:

```
# zypper update
```



Note

The new srHook script "SAPHanaSrMultiTarget.py" necessary for multi-target setup is not available in the installation ISO media and only available from update channels of SUSE Linux Enterprise Server for SAP Applications 15 SP3 or earlier. Thus, for a correctly working multi-target setup, a full system patching is mandatory. From SUSE Linux Enterprise Server for SAP Applications 15 SP4 onwards the "SAPHanaSrMultiTarget.py" will be included in the ISO.

4.2 Configuring SUSE Linux Enterprise Server for SAP Applications to run SAP HANA

4.2.1 Tuning or modifying the operating system

Operating system tuning are described in SAP note 1275776 and 2684254. The SAP note 1275776 explains three ways to implementing the settings.

EXAMPLE 4: USING SAPTUNE (PREFERRED)

```
# saptune solution apply HANA
```

4.2.2 Enabling SSH access via public key (optional)

Public key authentication provides SSH users access to their servers without entering their passwords. SSH keys are also more secure than passwords, because the private key used to secure the connection is never shared. Private keys can also be encrypted. Their encrypted contents cannot easily be read. For the document at hand, a very simple but useful setup is used. This setup is based on only one ssh-key pair which enables SSH access to all cluster nodes.



Note

Follow your company security policy to set up access to the systems.

EXAMPLE 5: SSH KEY CREATION AND EXCHANGE

As user root create an SSH key on one node.

```
# ssh-keygen -t rsa
```

The ssh-key generation asks for missing parameters.

```
Generating public/private rsa key pair.
Enter file in which to save the key (/root/.ssh/id_rsa):
Enter passphrase (empty for no passphrase):
Enter same passphrase again:
Your identification has been saved in /root/.ssh/id_rsa.
Your public key has been saved in /root/.ssh/id_rsa.pub.
The key fingerprint is:
SHA256:ip/8kdTbYZNuuEUAdsaY0AERkwnkAPBR7d25QIpIZCU root@<host1>
The key's randomart image is:
+---[RSA 2048]-----+
|XE000+000+o      |
|+=+. = 0=.0+.    |
|..B o. + o.      |
|  (°<            |
| / )             |
|  --             |
|  B. . o o =     |
|    o . . +      |
|    +. . .        |
+-----[SHA256]-----+
```

After the `ssh-keygen` is set up, you will have two new files under `/root/.ssh/`.

```
# ls /root/.ssh/
id_rsa id_rsa.pub
```

Collect the public host keys from all other node. For the document at hand, the `ssh-keyscan` command is used.

```
# ssh-keyscan
```

The SSH host key is automatically collected and stored in the file `/root/.ssh/known_host` during the first SSH connection. To avoid to confirm the first login with "yes", which accepts the host key, collect and store them beforehand.

```
# ssh-keyscan -t ecdsa-sha2-nistp256 <host1>,<host1 ip> >>.ssh/known_hosts
# ssh-keyscan -t ecdsa-sha2-nistp256 <host2>,<host2 ip> >>.ssh/known_hosts
# ssh-keyscan -t ecdsa-sha2-nistp256 <host3>,<host3 ip> >>.ssh/known_hosts
...
```

After collecting all host keys store them in a file named `authorized_keys`. Push the entire directory `/root/.ssh/` from the first node to all further cluster members.

```
# rsync -ay /root/.ssh/ <host2>:/root/.ssh/
# rsync -ay /root/.ssh/ <host3>:/root/.ssh/
# rsync -ay /root/.ssh/ <host4>:/root/.ssh/
...
```

4.2.3 Setting up disk layout for SAP HANA

An SAP certified storage system with a validated storage API is generally recommended. This is a prerequisite of a stable and reliable scale-out installation.

- `/hana/shared/<SID>`
- `/hana/data/<SID>`
- `/hana/log/<SID>`

Create the mount directories on all SAP HANA nodes.

```
# mkdir -p /hana/shared/<SID>
# mkdir -p /hana/data/<SID>
# mkdir -p /hana/log/<SID>
# mkdir -p /usr/sap
```

The SAP HANA installation needs a special storage setup. The NFS setup used for this guide must be reboot-persistent. You can achieve this with entries in the `/etc/fstab`.



Note

NFS version 4 is required in the setup at hand.

EXAMPLE 6: CREATE PERMANENT MOUNT ENTRIES FOR ALL NFS POOLS

Create `/etc/fstab` entries for the three NFS pools.

```
<nfs> /hana/shared/<SID> nfs4 defaults 0 0
```

In the sample environment those lines are as follows:

```
/exports/TST_WDF1/shared /hana/shared/TST nfs4 defaults 0 0
```

Mount all NFS shares.

```
# mount -a
```

Create other directories (optional).

```
# mkdir -p /sapsoftware
```

File systems

/hana/shared/<SID>

The mount directory is used for shared files between all hosts in an SAP HANA system. Each HANA site has its own instance of this directory. It is accessible to the two nodes of that site. In our setup we use NFS.

/hana/log/<SID>

The default path to the log directory depends on the SAP System ID of the SAP HANA host. In our setup each HANA site has its own instance of this directory. It is accessible to the two nodes of that site. Each node has its own subdirectories. In our setup we use NFS. It would be possible to use local disks instead.

/hana/data/<SID>

The default path to the data directory depends on the system ID of the SAP HANA host. In our setup each HANA site has its own instance of this directory. It is accessible to the two nodes of that site. Each node has its own subdirectories. In our setup we use NFS. It would be possible to use local disks instead.

/usr/sap

This is the path to the local SAP system instance directories. It is possible to join this location with the Linux installation.

/sapsoftware

(optional) Space for copying the SAP install software media. This NFS pool is mounted on all HANA sites and contains the SAP HANA installation media and installation parameter files.

Set up host name resolution for all machines. You can either use a DNS server or modify the */etc/hosts* on **all** nodes.

With maintaining the `/etc/hosts` file, you minimize the impact of a failing DNS service. Replace the IP address and the host name in the following commands.

```
# vi /etc/hosts
```

Insert the following lines to `/etc/hosts`. Change the IP address and host name to match your environment.

```
192.168.201.151 hanaso0
192.168.201.152 hanaso2
...
```

Enable NTP service on all nodes.

Simply enable an **ntp service** on all node in the cluster to have proper time synchronization.

```
# yast2 ntp-client
```

5 Installing the SAP HANA databases on both sites

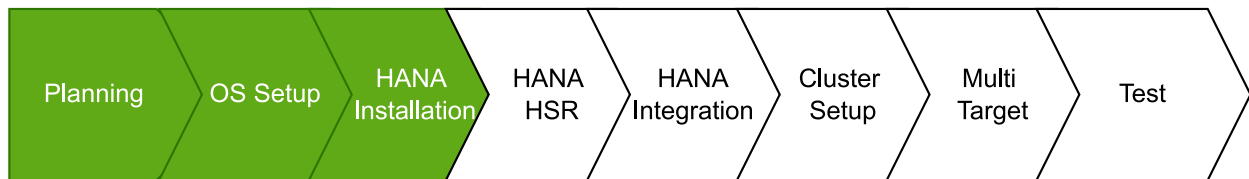

FIGURE 8: SECTION 3, “PLANNING THE INSTALLATION” (PAGE 9) [OSSETUP] SAPHANAINST [SAPHANAHSR] SECTION 7, “INTEGRATING SAP HANA WITH THE LINUX CLUSTER” (PAGE 37) SECTION 8, “CONFIGURING THE CLUSTER AND SAP HANA RESOURCES” (PAGE 44) SECTION 9, “SETUP OF A SCALE-OUT MULTI-TARGET ARCHITECTURE” (PAGE 58) [TESTING]

The infrastructure is set up. Now install the SAP HANA database at both sites. This chapter summarizes the test environment. In a cluster a machine is also called a *node*. Always use the official documentation from SAP to install SAP HANA and to set up the system replication.

This guide shows SAP HANA and saphostagent with native systemd integration. An example for legacy SystemV is outlined in the appendix [Section 11.3, “Example for checking legacy SystemV integration”](#).

PROCEDURE

1. Install the SAP HANA database on all SAP HANA nodes.
2. Check if the SAP hostagent is installed on all SAP HANA nodes.
3. Verify that both databases are up and running.

In the example at hand, to make it easier to follow the documentation, the machines (or nodes) are named *hanaso0*, ... *hanasoX*. The nodes (*hanaso0*, *hanaso1*) will be part of site "A" (WDF1), the nodes (*hanaso2*, *hanaso3*) will be part of site "B" (ROT1), and the nodes (*hanaso4*, *hanaso5*) will be part of site "C" (FRA1).

The following users are automatically created during the SAP HANA installation:

<sid>adm

The user <sid> adm is the operating system user required for administrative tasks, such as starting and stopping the system.

sapadm

The SAP Host Agent administrator.

SYSTEM

The SAP HANA database superuser.

5.1 Install the SAP HANA database

- Read the SAP Installation and Setup Manuals available at the SAP Marketplace.
- Download the SAP HANA Software from SAP Marketplace.
- Mount the file systems to install SAP HANA database software and database content (data and log).
- Start the installation.

1. Mount /hana/shared from the nfs server.

```
# for system in hanaso{0,1,2,3,4,5}; do
  ssh $system mount -a
done
```

2. Install the SAP HANA Database as described in the SAP HANA Server Installation Guide on **all** machines (three sites) except the majority maker. All three databases need to have same SID and instance number. You can use either the graphical user interface or the command line installer *hdblcm*. The command line installer can be used in an interactive or batch mode.

EXAMPLE 7: USING HDBLCM IN INTERACTIVE MODE

```
# <path_to_sap_media>/hdblcm
```

Alternatively you can also use the batch mode of *hdblcm*. This can either be done by specifying all needed parameters via the command line or by using a parameter file.

In the example at hand the command line parameters are used. In the batch mode you need to provide an XML password file (here <path>/hana_passwords). A template of this password file can be created with the following command:

EXAMPLE 8: CREATING A PASSWORD FILE

```
# <path_to_sap_media>/hdblcm --dump_configfile_template=templateFile
```

This command creates two files:

- *templateFile* is the template for a parameter file.
- *templateFile.xml* is the XML template used to provide several hana_passwords to the hdblcm installer.

The XML password file looks as follows:

EXAMPLE 9: THE XML PASSWORD TEMPLATE

```
<?xml version="1.0" encoding="UTF-8"?>
<!-- Replace the 3 asterisks with the password -->
<Passwords>
  <root_password><![CDATA[***]]></root_password>
  <sapadm_password><![CDATA[***]]></sapadm_password>
  <master_password><![CDATA[***]]></master_password>
  <sapadm_password><![CDATA[***]]></sapadm_password>
  <password><![CDATA[***]]></password>
  <system_user_password><![CDATA[***]]></system_user_password>
  <streaming_cluster_manager_password><![CDATA[***]]></
streaming_cluster_manager_password>
  <ase_user_password><![CDATA[***]]></ase_user_password>
  <org_manager_password><![CDATA[***]]></org_manager_password>
</Passwords>
```

After having created the XML password file, you can immediately start the SAP HANA installation in batch mode by providing all needed parameters via the command line.

EXAMPLE 10: USING HDBLCM IN BATCH MODE

In the example below the password file is used to provide the password during the installation dialog. All installation parameters are named directly as one command.

```
# cat <path>/hana_passwords | \  
<path_to_sap_media>/hdblcm \  
  --batch \  
  --sid=<SID>\  
  --number=<instanceNumber> \  
  --action=install \  
  --hostname=<node1> \  
  --addhosts=<node2>:role=worker \  
  --certificates_hostmap=<node1>=<node1> \  
  --certificates_hostmap=<node2>=<node2> \  
  --install_hostagent \  
  --system_usage=test \  
  --checkmnt=/hana/shared/<SID> \  
  --sapmnt=/hana/shared \  
  --datapath=<datapath> \  
  --logpath=<logpath> \  
  --root_user=root \  
  --workergroup=default \  
  --home=/usr/sap/<SID>/home \  
  --userid=<uid> \  
  --shell=/bin/bash \  
  --groupid=<gid> \  
  --read_password_from_stdin=xml
```

The second example use the modified template file as answering file.

```
# cat <path>/hana_passwords | \  
<path_to_sap_media>/hdblcm \  
  -b \  
  --configfile=<path_to_templateFile>/<mod_templateFile> \  
  --read_password_from_stdin=xml
```

5.2 Check if the SAP hostagent is installed on all SAP HANA nodes

Check if the native systemd enabled SAP hostagent and instance sapstartsrv are installed on all SAP HANA nodes. If not, install and enable it now.

As Linux user *root* run the command *systemctl* on all SAP HANA nodes to check the SAP hostagent and instance services:

```
# systemctl list-unit-files | grep sap
saphostagent.service enabled
sapinit.service generated
saprouter.service disabled
saptune.service enabled
```

The mandatory saphostagent service is enabled. This is the installation default. Some more SAP related services might be enabled, e.g. the recommended saptune.

The instance service SAP <SID>_<NR>.service needs to be enabled as well.

```
# systemctl list-unit-files | grep SAP
SAPTST_00.service enabled
```

The instance service is indeed enabled, as required.

5.3 Verify that both databases are up and running

Verify that both databases are up and running on all SAP HANA nodes. As Linux user *root* run the command *systemd-cgls* all SAP HANA nodes to check both databases:

```
# systemd-cgls -u SAP.slice
Unit SAP.slice (/SAP.slice):
├─saphostagent.service
│  ├─2630 /usr/sap/hostctrl/exe/saphostexec pf=/usr/sap/hostctrl/exe/host_profile -systemd
│  ├─2671 /usr/sap/hostctrl/exe/sapstartsrv pf=/usr/sap/hostctrl/exe/host_profile -D
│  └─3591 /usr/sap/hostctrl/exe/saposcol -l -w60 pf=/usr/sap/hostctrl/exe/host_profile
└─SAPTST_00.service
   ├─1257 hdbcompileserver
   ├─1274 hdbpreprocessor
   ├─1353 hdbindexserver -port 31003
   ├─1356 hdbxsengine -port 31007
   ├─2077 hdbwebdispatcher
   ├─2300 hdbrsutil --start --port 31003 --volume 3 --volumesuffix mnt00001/
   hdb00003.00003 --identifier 1644426276
   ├─28462 /usr/sap/TST/HDB00/exe/sapstartsrv pf=/usr/sap/TST/SYS/profile/
   TST_HDB00_hanaso0
   ├─31314 sapstart pf=/usr/sap/TST/SYS/profile/TST_HDB00_hanaso0
   ├─31372 /usr/sap/TST/HDB00/hanaso0/trace/hdb.sapTST_HDB00 -d -nw -f /usr/sap/TST/HDB00/
   suse21/daemon.ini pf=/usr/sap/TST/SYS/profile/TST_HDB00_hanaso1
   └─31479 hdbnameserver
```

```
└─32201 hdbrsutil --start --port 31001 --volume 1 --volumesuffix mnt00001/hdb00001 --
identifier 1644426203
```

The SAP hostagent `saphostagent.service` and the instance's `sapstartsrv SAPTST_00.service` are running in the `SAP.slice`. See also manual pages `systemctl(8)` and `systemd-cgls(8)` for details.

Use the python script `landscapeHostConfiguration.py` to show the status of an entire SAP HANA site. The landscape host configuration is shown with a line per SAP HANA host. Query the host roles (as user `<sid> adm`):

```
~> HDBSettings.sh landscapeHostConfiguration.py

| Host | Host | ... NameServer | NameServer | IndexServer | IndexServer
|      | Active | ... Config Role | Actual Role | Config Role | Actual Role
| ----- | ----- | ... ----- | ----- | ----- | -----
| hanaso0 | yes | ... master 1 | master | worker | master
| hanaso1 | yes | ... master 2 | slave | worker | slave

overall host status: ok
```

Get an overview of instances of that site (as user `<sid> adm`) You should get a list of SAP HANA instances belonging to that site.

```
~> sapcontrol -nr <instanceNumber> -function GetSystemInstanceList
25.07.2022 17:25:16
GetSystemInstanceList
OK
hostname, instanceNr, httpPort, httpsPort, startPriority, features, dispstatus
hanaso0, 00, 50013, 50014, 0.3, HDB|HDB_WORKER, GREEN
hanaso1, 00, 50013, 50014, 0.3, HDB|HDB_WORKER, GREEN
```

6 Setting up SAP HANA system replication

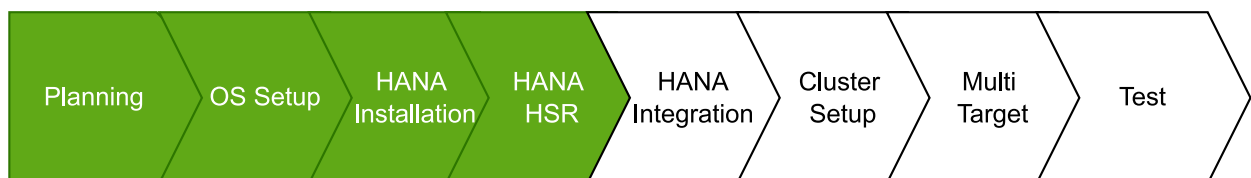

FIGURE 9: SECTION 3, "PLANNING THE INSTALLATION" (PAGE 9) [OSSETUP] [SAPHANAINST] SAPHANAHSR SECTION 7, "INTEGRATING SAP HANA WITH THE LINUX CLUSTER" (PAGE 37) SECTION 8, "CONFIGURING THE CLUSTER AND SAP HANA RESOURCES" (PAGE 44) SECTION 9, "SETUP OF A SCALE-OUT MULTI-TARGET ARCHITECTURE" (PAGE 58) [TESTING]

This section describes the setup of the system replication (HSR) after SAP HANA has been installed properly.

PROCEDURE

1. Back up the primary database
2. Enable the primary database
3. Register the secondary database
4. Verify the system replication

For more information read the Section *Setting Up System Replication* of the SAP HANA Administration Guide.

6.1 Backing up the primary database

First back up the primary database as described in the *SAP HANA Administration Guide, Section SAP HANA Database Backup and Recovery*.

Below find examples to back up SAP HANA with SQL Commands:

EXAMPLE 11: SIMPLE BACKUP FOR THE SYSTEM DATABASE AND ALL TENANTS WITH ONE SINGLE BACKUP CALL

As user <sid> adm enter the following command:

```
~> hdbsql -i {refInst} -u SYSTEM -d SYSTEMDB \  
"BACKUP DATA FOR FULL SYSTEM USING FILE ('backup')"
```

You get the following command output (or similar):

```
0 rows affected (overall time 15.352069 sec; server time 15.347745 sec)
```

EXAMPLE 12: SIMPLE BACKUP FOR A SINGLE CONTAINER (NON-MDC) DATABASE

Enter the following command as user <sid> adm:

```
~> hdbsql -i <instanceNumber> -u <dbuser> \  
"BACKUP DATA USING FILE ('backup')"
```



Important

Without a valid backup, you **cannot** bring SAP HANA into a system replication configuration.

6.2 Enabling the primary database

As Linux user `<sid>adm` enable the system replication at the primary node. You need to define a site name (like `WDF1`) which must be unique for all SAP HANA databases which are connected via system replication. This means the secondary must have a different site name.

EXAMPLE 13: ENABLE THE SYSTEM REPLICATION ON THE PRIMARY SITE

As user `<sid>adm` enable the primary:

```
~> hdbnsutil -sr_enable --name=WDF1
```

Check if the command output is similar to:

```
nameserver is active, proceeding ...
successfully enabled system as system replication source site
done.
```

The command line tool `hdbnsutil` can be used to check the system replication mode and site name.

EXAMPLE 14: CHECK THE SYSTEM REPLICATION CONFIGURATION STATUS AS USER `<SID>ADM` ON THE PRIMARY

```
~> hdbnsutil -sr_stateConfiguration
```

If the system replication enablement was successful at the primary, the output should be as follows:

```
checking for active or inactive nameserver ...
System Replication State
~~~~~

mode: primary
site id: 1
site name: WDF1
done.
```

The mode has changed from “none” to “primary” and the site now has a site name and a site ID.

6.3 Registering the secondary database

The SAP HANA database instance on the secondary side must be stopped before the system can be registered for the system replication. You can use your preferred method to stop the instance (like `HDB` or `sapcontrol`). After the database instance has been stopped successfully, you can register the instance using `hdbnsutil`.

EXAMPLE 15: STOP THE SECONDARY AS LINUX USER <SID>ADM:

```
~> sapcontrol -nr <instanceNumber> -function StopSystem
```

EXAMPLE 16: COPY THE KEY AND KEY-DATA FILE FROM THE PRIMARY TO THE SECONDARY SITE

The copy of key and key-data should only be done on the master name server. As the files are in the global file space, you do not need to run the command on all cluster nodes.

```
cd /usr/sap/<SID>/SYS/global/security/rsecssfs
rsync -va {,<node1-siteB>:}$PWD/data/SSFS_<SID>.DAT
rsync -va {,<node1-siteB>:}$PWD/key/SSFS_<SID>.KEY
```

EXAMPLE 17: REGISTER THE SECONDARY AS LINUX USER <SID>ADM:

```
~> hdbnsutil -sr_register --name=<site2> \
--remoteHost=<node1-siteA> --remoteInstance=<instanceNumber> \
--replicationMode=sync --operationMode=logreplay
```

```
adding site ...
checking for inactive nameserver ...
nameserver hanaso2:30001 not responding.
collecting information ...
updating local ini files ...
done.
```

The *remoteHost* is the primary node in our case, the *remoteInstance* is the database instance number (here 00).

Now start the database instance again and verify the system replication status. On the secondary site, the mode should be one of „SYNC“, „SYNCMEM“ or „ASYNCR“. The mode depends on the **sync** option defined during the registration of the secondary.

EXAMPLE 18: START THE SYSTEM ON THE SECONDARY SITE AS USER <SID>ADM

```
~> sapcontrol -nr <instanceNumber> -function StartSystem
```

Wait until the SAP HANA database is started completely.

EXAMPLE 19: CHECK THE SYSTEM REPLICATION CONFIGURATION AS LINUX USER <SID>ADM

```
~> hdbnsutil -sr_stateConfiguration
```

The output should look like the following:

```
System Replication State
~~~~~
mode: sync
site id: 2
site name: ROT1
active primary site: 1

primary masters: hanaso0 hanaso1
done.
```

6.4 Verifying the system replication

To view the replication state of the whole SAP HANA cluster, use the following command as `<sid> adm` user on the primary site.

EXAMPLE 20: CHECK THE SYSTEM REPLICATION STATUS AT THE PRIMARY SITE (AS `<SID>ADM`)

```
~> HDBSettings.sh systemReplicationStatus.py
```

This script prints a human-readable table of the system replication channels and their status. The most interesting column is the **Replication Status**, which should be **ACTIVE**.

Database	Host	.. Site Name	Secondary	.. Secondary	.. Replication
		..	Host	.. Site Name	.. Status
-----	-----	.. -----	-----	.. -----	.. -----
SYSTEMDB	hanaso0	.. WDF1	hanaso2	.. ROT1	.. ACTIVE
TST	hanaso0	.. WDF1	hanaso2	.. ROT1	.. ACTIVE
TST	hanaso0	.. WDF1	hanaso2	.. ROT1	.. ACTIVE
TST	hanaso1	.. WDF1	hanaso3	.. ROT1	.. ACTIVE

```
status system replication site "2": ACTIVE
overall system replication status: ACTIVE
```

```
Local System Replication State
```

```
~~~~~
mode: PRIMARY
site id: 1
site name: WDF1
```

7 Integrating SAP HANA with the Linux cluster

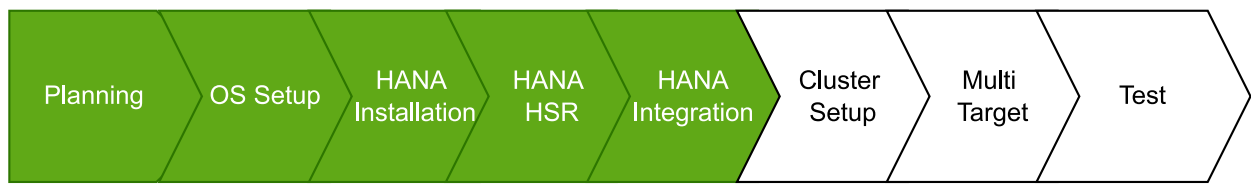

FIGURE 10: SECTION 3, “PLANNING THE INSTALLATION” (PAGE 9) [OSSETUP] [SAPHANAINST] [SAPHANAHSR] INTEGRATION SECTION 8, “CONFIGURING THE CLUSTER AND SAP HANA RESOURCES” (PAGE 44) SECTION 9, “SETUP OF A SCALE-OUT MULTI-TARGET ARCHITECTURE” (PAGE 58) [TESTING]

This chapter describes what to change on the SAP HANA configuration for the ERP style scale-out multi-target scenario.

PROCEDURE

1. Stop SAP HANA
2. Configure system replication operation mode
3. Adapt SAP HANA nameserver configuration
4. Implement SAPHanaSrMultiTarget.py for srConnectionChanged
5. Implement susChkSrv.py for srServiceStateChanged
6. Implement susTkOver.py for preTakeover
7. Allow <sid> adm to access the cluster
8. Start SAP HANA
9. Test the HA/DR provider hook script integration



Note

All hook scripts should be used directly from the SAPHanaSR-ScaleOut package. If the scripts are moved or copied, regular SUSE package updates will not work.

7.1 Stopping SAP HANA

The SAP HANA needs to be stopped at both sites that will be part of the Linux cluster. At each site do the following:

```
# su - <sid>adm
```

```
~> sapcontrol -nr <instanceNumber> -function StopSystem
~> sapcontrol -nr <instanceNumber> -function WaitforStopped 300 20
~> sapcontrol -nr <instanceNumber> -function GetSystemInstanceList
```

7.2 Configuring the system replication operation mode

When your system is connected as an SAPHanaSR target, you can find an entry in the *global.ini* file which defines the operation mode. Up to now there are three modes available:

- *delta_datashipping*
- *logreplay*
- *logreplay_readaccess*

Until performing a takeover and re-registration in the opposite direction, the entry for the operation mode is missing on your primary site. The default and preferred mode for HA is *logreplay*. Using the operation mode *logreplay* makes your secondary site in the SAP HANA system replication a hot standby system. For more details regarding replication modes check the SAP documentation such as "How To Perform System Replication for SAP HANA" (see <https://www.sap.com/documents/2013/10/26c02b58-5a7c-0010-82c7-eda71af511fa.html>).

For a multi-target setup, site 3 should follow the primary SAP HANA after takeover. For this a configuration 'register_secondaries_on_takeover = true' needs to be added in the system_replication block of the *global.ini* file. This configuration needs to be added on the two SAP HANA sites in the Linux cluster.

Check both *global.ini* files and add the operation mode, if needed. Also add the 'register_secondaries_on_takeover = true' for multi-target setups.

Path for the *global.ini*: /hana/shared/ <SID> /global/hdb/custom/config/global.ini

```
[system_replication]
operation_mode = logreplay
register_secondaries_on_takeover = true
```

7.3 Adapting SAP HANA name server configuration

We need change the 'nameserver.ini' for the two sites controlled by the Linux cluster. This change ensures that there is no second master name server candidate as this is an ERP style setup. By default during the SAP HANA installation the second node at each site will be configured as the master name server candidate. We need to remove the second node from the line starting with 'master ='. The below example is given for instance number '00'.

Before configuration change:

```
[landscape]
...
master = hanaso0:30001 hanaso1:30001
worker = hanaso0 hanaso1
active_master = hanaso0:30001
```

After configuration change:

```
[landscape]
...
master = hanaso0:30001
worker = hanaso0 hanaso1
active_master = hanaso0:30001
```

Refer to SAP HANA documentation for details.

7.4 Implementing SAPHanaSrMultiTarget.py for srConnectionChanged

This step must be done on both sites that will be part of the cluster. Use the SAP HANA tools for changing global.ini and integrating the hook script. In global.ini, the section `[ha_dr_provider_saphanasrmultitarget]` needs to be created. The section `[trace]` might be adapted. The ready-to-use HA/DR hook script is shipped with the SAPHanaSR-ScaleOut package in directory `/usr/share/SAPHanaSR-ScaleOut/`. The hook script must be available on all cluster nodes, including the majority maker. Find more details in manual pages `SAPHanaSrMultiTarget.py(7)` and `SAPHanaSR-manageProvider(8)`.

EXAMPLE 21: **ADDING SAPHANASRMULTITARGET.PY VIA GLOBAL.INI**

```
[ha_dr_provider_saphanasrmultitarget]
provider = SAPHanaSrMultiTarget
```

```
path = /usr/share/SAPHanaSR-ScaleOut/  
execution_order = 1  
  
[trace]  
ha_dr_saphanasrmultitarget = info
```

It is again reminded that the srHook script "SAPHanaSrMultiTarget.py" necessary for multi-target setup is not available in the installation ISO media. It is only available in update channels of SUSE Linux Enterprise Server for SAP Applications 15 SP3 or earlier. So, for a correctly working multi-target setup a full system patching is mandatory after registering the system to SCC, RMT or SUSE Manager. From SUSE Linux Enterprise Server for SAP Applications 15 SP4 onwards the "SAPHanaSrMultiTarget.py" is included in the ISO.

7.5 Implementing susChkSrv.py for srServiceStateChanged

This step must be done on both sites that will be part of the cluster. Use the SAP HANA tools for changing global.ini and integrating the hook script. In global.ini, the section `[ha_dr_provider_suschkdrv]` needs to be created. The section `[trace]` might be adapted. The ready-to-use HA/DR hook script is shipped with the SAPHanaSR-ScaleOut package in directory `/usr/share/SAPHanaSR-ScaleOut/`. The hook script must be available on all cluster nodes, including the majority maker. Find more details in manual pages `susChkSrv.py(7)` and `SAPHanaSR-manageProvider(8)`.

EXAMPLE 22: ADDING SUSCHKSRV.PY VIA GLOBAL.INI

```
[ha_dr_provider_suschkdrv]  
provider = susChkSrv  
path = /usr/share/SAPHanaSR-ScaleOut/  
execution_order = 3  
action_on_lost = stop  
  
[trace]  
ha_dr_suschkdrv = info
```

It is again reminded that the srHook script "susChkSrv.py" is not available in the installation ISO media. It is only available in update channels of SUSE Linux Enterprise Server for SAP Applications 15 SP4 or earlier. So, for a correctly working setup a full system patching is mandatory after registering the system to SCC, RMT or SUSE Manager. From SUSE Linux Enterprise Server for SAP Applications 15 SP5 onwards the "susChkSrv.py" will be included in the ISO.

7.6 Implementing susTkOver.py for preTakeover

This step must be done on both sites that will be part of the cluster. Use the SAP HANA tools for changing global.ini and integrating the hook script. In global.ini, the section `[ha_dr_provider_sustkover]` needs to be created. The section `[trace]` might be adapted. The ready-to-use HA/DR hook script is shipped with the SAPHanaSR-ScaleOut package in directory `/usr/share/SAPHanaSR-ScaleOut/`. The hook script must be available on all cluster nodes, including the majority maker. Find more details in manual pages `susTkOver.py(7)` and `SAPHanaSR-manageProvider(8)`.

EXAMPLE 23: ADDING SUSTKOVER.PY VIA GLOBAL.INI

```
[ha_dr_provider_sustkover]
provider = susTkOver
path = /usr/share/SAPHanaSR-ScaleOut/
execution_order = 2
sustkover_timeout = 30

[trace]
ha_dr_sustkover = info
```

It is again reminded that the srHook script "susTkOver.py" is not available in the installation ISO media. It is only available in update channels of SUSE Linux Enterprise Server for SAP Applications 15 SP4 or earlier. So, for a correctly working setup a full system patching is mandatory after registering the system to SCC, RMT or SUSE Manager. From SUSE Linux Enterprise Server for SAP Applications 15 SP5 onwards the "susTkOver.py" will be included in the ISO.

7.7 Allowing <sid>adm to access the cluster

The current version of the SAPHanaSrMultiTarget.py python hook uses the command `sudo` to allow the `<sid>adm` user to access the cluster attributes. In Linux you can use `visudo` to start the vi editor for the Linux system `/etc/sudoers`. We recommend to use a specific file `/etc/sudoers.d/SAPHanaSR` instead. That file can be edited by plain vi, or handled by any configuration management.

The user `<sid>adm` must be able to set the cluster attributes `hana_<sid>_site_srHook_*` and `hana_<sid>_gsh`. The SAP HANA system replication hook needs password free access. The following example limits the sudo access to exactly setting the needed attribute. See manual pages `sudoers(5)`, `SAPHanaSrMultiTarget.py(7)` and `susChkSrv.py(7)` for details.

EXAMPLE 24: ENTRY IN SUDO PERMISSIONS /ETC/SUDOERS.D/SAPHANASR FILE

Example for basic options to allow <sid> adm to use the hook scripts. Replace the <sid> by the lowercase SAP system ID. Replace the <SID> by the uppercase SAP system ID.

```
# SAPHanaSR-ScaleOut needs for HA/DR hook scripts
<sid>adm ALL=(ALL) NOPASSWD: /usr/sbin/crm_attribute -n hana_<sid>_site_srHook_*
<sid>adm ALL=(ALL) NOPASSWD: /usr/sbin/crm_attribute -n hana_<sid>_gsh *
<sid>adm ALL=(ALL) NOPASSWD: /usr/sbin/crm_attribute -n hana_<sid>_glob_mts *
<sid>adm ALL=(ALL) NOPASSWD: /usr/sbin/SAPHanaSR-hookHelper --sid=<SID> *
```

Example for looking up the sudo permissions for the hook scripts.

```
# sudo -U <sid>adm -l | grep "NOPASSWD"
```

7.8 Starting SAP HANA

After having completed the SAP HANA configuration and having configured the communication between SAP HANA and the Linux cluster, you can start the SAP HANA database on both sites.

EXAMPLE 25: STARTING A COMPLETE SAP HANA SITE AS USER <SID>ADM

```
~> sapcontrol -nr <instanceNumber> -function StartSystem
```

The *sapcontrol* service commits the request with OK.

```
11.11.2022 11:11:01
StartSystem
OK
```

Check if SAP HANA has finished starting.

```
~> sapcontrol -nr <instanceNumber> -function WaitForStarted 300 20
~> sapcontrol -nr <instanceNumber> -function GetSystemInstanceList
```

7.9 Testing the HA/DR provider hook script integration

When the SAP HANA database has been restarted after the changes, check if the hook scripts have been loaded correctly. A useful verification is to check the SAP HANA trace files as <sid> adm. More complete checks will be done later, when the Linux cluster is up and running.

7.9.1 Checking for SAPHanaSrMultiTarget.py

Check if SAP HANA has initialized the SAPHanaSrMultiTarget.py hook script for the srConnectionChanged events. Check the HANA name server trace files and the specific hook script trace file. Do this on both sites' master name server. See also manual page SAPHanaSrMultiTarget.py(7).

```
~> cdtrace
~> grep HADR.*load.*SAPHanaSrMultiTarget nameserver_*.trc | tail -3
~> grep SAPHanaSr.*init nameserver_*.trc | tail -3
~> grep -A5 "init.called" nameserver_saphanasr_multitarget_hook.trc
```

7.9.2 Checking for susChkSrv.py

Check if SAP HANA has initialized the susChkSrv.py hook script for the srServiceStateChanged events. Check the HANA name server trace files and the specific hook script trace file. Do this on all nodes. See also manual page susChkSrv.py(7).

```
~> cdtrace
~> grep HADR.*load.*susChkSrv nameserver_*.trc | tail -3
~> grep susChkSrv.init nameserver_*.trc | tail -3
```

7.9.3 Checking for susTkOver.py

Check if SAP HANA has initialized the susTkOver.py hook script for the preTakeover events. Check the HANA name server trace. Do this on all nodes. See also manual page susTkOver.py(7).

```
~> cdtrace
~> grep HADR.*load.*susTkOver nameserver_*.trc | tail -3
~> grep susTkOver.init nameserver_*.trc | tail -3
```

8 Configuring the cluster and SAP HANA resources



FIGURE 11: SECTION 3, “PLANNING THE INSTALLATION” (PAGE 9) [OSSETUP] [SAPHANAINST] [SAPHANAHSR] SECTION 7, “INTEGRATING SAP HANA WITH THE LINUX CLUSTER” (PAGE 37) CLUSTER SECTION 9, “SETUP OF A SCALE-OUT MULTI-TARGET ARCHITECTURE” (PAGE 58) [TESTING]

This chapter describes the configuration of the SUSE Linux Enterprise High Availability Extension cluster. The SUSE Linux Enterprise High Availability Extension is part of SUSE Linux Enterprise Server for SAP Applications. Further, the integration of SAP HANA System Replication with the SUSE Linux Enterprise High Availability Extension cluster is explained. The integration is done by using the SAPHanaSR-ScaleOut package which is also part of SUSE Linux Enterprise Server for SAP Applications.

PROCEDURE

1. Install the cluster packages
2. Basic cluster configuration
3. Configure cluster properties and resources
4. Final steps

8.1 Installing the cluster packages

If not already done, install the pattern *High Availability* on **all** nodes.

To do so, use zypper.

```
# zypper in -t pattern ha_sles
```

Now the Resource Agents for controlling the SAP HANA system replication need to be installed at **all** cluster nodes, including the majority maker.

```
# zypper in SAPHanaSR-ScaleOut
```

If you have the packages installed before, make sure to get the newest updates on **all** nodes

```
# zypper patch
```

8.2 Configuring the basic cluster

After having installed the cluster packages, the next step is to set up the basic cluster framework. For convenience, use YaST or the *ha-cluster-init* script.

Important

It is strongly recommended to add a second corosync ring, implement unicast (UCAST) communication and adjust the timeout values to your environment.

Prerequisites

- Name resolution
- Time synchronization
- Redundant network for cluster intercommunication
- STONITH method

8.2.1 Setting up watchdog for "Storage-based Fencing"

It is recommended to use SBD as central STONITH device, as done in the example at hand. Each node constantly monitors connectivity to the storage device, and terminates itself in case the partition becomes unreachable. Whenever SBD is used, a correctly working watchdog is crucial. Modern systems support a hardware watchdog that needs to be "tickled" or "fed" by a software component. The software component (usually a daemon) regularly writes a service pulse to the watchdog. If the daemon stops feeding the watchdog, the hardware will enforce a system restart. This protects against failures of the SBD process itself, such as dying, or getting stuck on an I/O error.

EXAMPLE 26: SET UP FOR WATCHDOG

Important

Access to the Watchdog Timer: No other software must access the watchdog timer. Some hardware vendors ship systems management software that uses the watchdog for system resets (for example, HP ASR daemon). Disable such software, if watchdog is used by SBD.

Determine the right watchdog module. Alternatively, you can find a list of installed drivers with your kernel version.

```
# ls -l /lib/modules/$(uname -r)/kernel/drivers/watchdog
```

Check if any watchdog module is already loaded.

```
# lsmod | egrep "(wd|dog|i6|iT|ibm)"
```

If you get a result, the system has already a loaded watchdog. If the watchdog does not match your watchdog device, you need to unload the module.

To safely unload the module, check first if an application is using the watchdog device.

```
# lsof /dev/watchdog  
# rmmod <wrong_module>
```

Enable your watchdog module and make it persistent. For the example below, *softdog* has been used which has some restrictions and should not be used as first option.

```
# echo softdog > /etc/modules-load.d/watchdog.conf  
# systemctl restart systemd-modules-load
```

Check if the watchdog module is loaded correctly.

```
# lsmod | grep dog
```

Testing the watchdog can be done with a simple action. Ensure to switch of your SAP HANA first because watchdog will force an unclean reset/shutdown of your system.

In case of a hardware watchdog a desired action is predefined after the timeout of the watchdog has reached. If your watchdog module is loaded and not controlled by any other application, do the following:

Important

Triggering the watchdog without continuously updating the watchdog resets/switches off the system. This is the intended mechanism. The following commands will force your system to be reset/switched off.

```
# touch /dev/watchdog
```

In case the *softdog* module is used the following action can be performed:

```
# echo 1 > /dev/watchdog
```

After your test was successful you can implement the watchdog on all cluster members. The example below applies to the `softdog` module. Replace `<wrong_module>` by the module name queried before.

```
# for i in hana{so0,so1,so2,so3,mm}; do
  ssh -T $i <<EOSSH
    hostname
    rmmod <wrong_module>
    echo softdog > /etc/modules-load.d/watchdog.conf
    systemctl restart systemd-modules-load
    lsmod |grep -e dog
EOSSH
done
```

8.2.2 Basic cluster configuration using *ha-cluster-init*

For more detailed information about `ha-cluster-*` tools, see section *Overview of the Bootstrap Scripts* of the Installation and Setup Quick Start Guide for SUSE Linux Enterprise High Availability Extension at <https://documentation.suse.com/sle-ha/15-SP1/single-html/SLE-HA-install-quick/#sec-ha-inst-quick-bootstrap>.

Create an initial setup by using the `ha-cluster-init` command. Follow the dialog steps.



Note

This is **only** to be done on the **first** cluster node. If you are using SBD as STONITH mechanism, you need to first load the watchdog kernel module matching your setup. In the example at hand the `softdog` kernel module is used.

The command `ha_cluster-init` configures the basic cluster framework including:

- SSH keys
- `csync2` to transfer configuration files
- SBD (at least one device)
- `corosync` (at least one ring)
- HAWK Web interface

```
# ha-cluster-init -u -s <sbd-device>
```

As requested by *ha-cluster-init*, change the password of the user *hacluster* on all cluster nodes.



Note

Do not forget to change the password of the user *hacluster*.

8.2.3 Cluster configuration for all other cluster nodes

The other nodes of the cluster could be integrated by starting the command *ha-cluster-join*. This command asks for the IP address or name of the **first** cluster node. Then all needed configuration files are copied over. As a result the cluster is started on **all** nodes. Do not forget the majority maker.

If you are using SBD as STONITH method, you need to activate the *softdog* kernel module matching your systems. In the example at hand the *softdog* kernel module is used.

```
# ha-cluster-join -c <host1>
```

8.2.4 Checking the cluster for the first time

Now it is time to check and optionally start the cluster for the first time on all nodes.

```
# crm cluster run "crm cluster start"
```



Note

All nodes should be started in parallel. Otherwise unseen nodes might get fenced.

Check whether all cluster nodes have registered at the SBD device(s). See manual page `cs_show_sbd_devices(8)` for details.

```
# cs_show_sbd_devices
```

Check the cluster status with `crm_mon`. Use the option `-r` to also see resources which are configured but stopped.

```
# crm_mon -r
```

The command will show the empty cluster and will print something like the screen output below. The most interesting information in this output is that there are two nodes in the status "online" and the message "partition with quorum".

```
Stack: corosync
Current DC: hanamm (version 1.1.16-4.8-77ea74d) - partition with quorum
Last updated: Mon July 25 16:55:04 2022
Last change: Mon July 25 16:53:58 2022 by root via crm_attribute on hanaso2

7 nodes configured
1 resource configured

Online: [ hanamm hanaso0 hanaso1 hanaso2 hanaso3 ]

Full list of resources:

stonith-sbd      (stonith:external/sbd): Started hanamm
```

8.3 Configuring cluster properties and resources

This section describes how to configure bootstrap, STONITH, resources, and constraints using the `crm` configure shell command as described in section *Configuring and Managing Cluster Resources (Command Line)* of the SUSE Linux Enterprise High Availability Extension Administration Guide (see <https://documentation.suse.com/sle-ha/15-SP1/html/SLE-HA-all/cha-ha-manual-config.html> ↗).

Use the command `crm` to add the objects to the Cluster Resource Management (CRM). Copy the following examples to a local file and then load the configuration to the Cluster Information Base (CIB). The benefit is that you have a scripted setup and a backup of your configuration.

Perform all `crm` commands only on **one** node, for example on machine `hanaso0`.

First write a text file with the configuration, which you load into your cluster in a second step. This step is as follows:

```
# vi crm-file<XX>
# crm configure load update crm-file<XX>
```

8.3.1 Cluster bootstrap and more

The first example defines the cluster bootstrap options including the resource and operation defaults.

The `stonith-timeout` should be greater than 1.2 times the SBD `msgwait` timeout. Find more details and examples in manual page `SAPHanaSR-ScaleOut_basic_cluster(7)`.

```
# vi crm-bs.txt
```

Enter the following to `crm-bs.txt`:

```
property cib-bootstrap-options: \  
    have-watchdog=true \  
    cluster-infrastructure=corosync \  
    cluster-name=hacluster \  
    placement-strategy=balanced \  
    no-quorum-policy=freeze \  
    stonith-enabled=true \  
    concurrent-fencing=true \  
    stonith-action=reboot \  
    stonith-timeout=150  
rsc_defaults rsc-options: \  
    resource-stickiness=1000 \  
    migration-threshold=50  
op_defaults op-options: \  
    timeout=600 \  
    record-pending=true
```

Now add the configuration to the cluster.

```
# crm configure load update crm-bs.txt
```

8.3.2 STONITH

As already explained in the requirements, STONITH is crucial for a supported cluster setup. Without a valid fencing mechanism your cluster is unsupported.

A standard STONITH mechanism implements SBD based fencing. The SBD STONITH method is very stable and reliable and has proved very good road capability.

You can use other fencing methods available for example from your public cloud provider. However, it is crucial to intensively test the server fencing.

For SBD based fencing you can use one up to three SBD devices. The cluster will react differently when an SBD device is lost. The differences and SBD fencing are explained very well in the SUSE product documentation of the SUSE Linux Enterprise High Availability Extension available at <https://documentation.suse.com/>.

You need to adapt the SBD resource for the SAP HANA scale-out cluster.

As user <sid> adm create a file named for crm-fencing.txt.

EXAMPLE 27: CONFIGURE FENCING

```
# vi crm-fencing.txt
```

Enter the following to *crm-fencing.txt*:

```
primitive stonith-sbd stonith:external/sbd \  
params pcmk_action_limit=-1 pcmk_delay_max=1
```

Now load the configuration from the file to the cluster.

```
# crm configure load update crm-fencing.txt
```

8.3.3 Cluster in maintenance mode

Load the configuration for the resources and the constraints step-by-step to the cluster to explain the different parts. The best way to avoid unexpected cluster reactions is to

- first set the complete cluster to maintenance mode,
- then do all needed changes and,
- as last step, end the cluster maintenance mode.

```
# crm maintenance on
```

8.3.4 SAPHanaTopology

Next, define the group of resources needed, before the SAP HANA instances can be started. Prepare the changes in a text file, for example *crm-saphanatop.txt*, and load these with the *crm* command.

If necessary, change the **SID** and **instance number** (bold) to appropriate values for your setup.

EXAMPLE 28: CONFIGURE SAPHANATOPOLOGY

```
hanaso0:~ # vi crm-saphanatop.txt
```

Enter the following to *crm-saphanatop.txt*:

```
primitive rsc_SAPHanaTop_<SID>_HDB<instanceNumber> ocf:suse:SAPHanaTopology \  
params pcmk_delay_max=1
```

```

op monitor interval="10" timeout="600" \
op start interval="0" timeout="600" \
op stop interval="0" timeout="300" \
params SID="<SID>" InstanceNumber="<instanceNumber>"

```

```

clone cln_SAPHanaTop_<SID>_HDB<instanceNumber>
rsc_SAPHanaTop_<SID>_HDB<instanceNumber> \
meta clone-node-max="1" interleave="true"

```

```

primitive rsc_SAPHanaTop_TST_HDB00 ocf:suse:SAPHanaTopology \
op monitor interval="10" timeout="600" \
op start interval="0" timeout="600" \
op stop interval="0" timeout="300" \
params SID="TST" InstanceNumber="00"

```

```

clone cln_SAPHanaTop_TST_HDB00 rsc_SAPHanaTop_TST_HDB00 \
meta clone-node-max="1" interleave="true"

```

For additional information about all parameters, use the command `man ocf_suse_SAPHanaTopology`.

Again, add the configuration to the cluster.

```
# crm configure load update crm-saphanatop.txt
```

The most important parameters here are *SID* (TST) and *InstanceNumber* (00), which are self-explaining in an SAP context. Beside these parameters, the timeout values or the operations (start, monitor, stop) are typical values to be adjusted for your environment.

8.3.5 SAPHanaController

Next, define the group of resources needed, before the SAP HANA instances can be started. Edit the changes in a text file, for example `crm-saphanacon.txt` and load these with the command `crm`.

```
# vi crm-saphanacon.txt
```

EXAMPLE 29: CONFIGURE SAPHANACONTROLLER

Enter the following to `crm-saphanacon.txt`

```

primitive rsc_SAPHanaCon_<SID>_HDB<instanceNumber> ocf:suse:SAPHanaController \
op start interval="0" timeout="3600" \
op stop interval="0" timeout="3600" \

```

```

op promote interval="0" timeout="3600" \
op demote interval="0" timeout="320" \
op monitor interval="60" role="Master" timeout="700" \
op monitor interval="61" role="Slave" timeout="700" \
params SID="<SID>" InstanceNumber="<instanceNumber>" \
    PREFER_SITE_TAKEOVER="true" \
    DUPLICATE_PRIMARY_TIMEOUT="7200" AUTOMATED_REGISTER="false" \
    HANA_CALL_TIMEOUT="120"

ms msl_SAPHanaCon_<SID>_HDB<instanceNumber> \
    rsc_SAPHanaCon_<SID>_HDB<instanceNumber> \
    meta master-node-max="1" master-max="1" clone-node-max="1" interleave="true" \
    maintenance="true"

```

The most important parameters here are <SID> (TST) and <instanceNumber> (00), which are in the SAP context quite self explaining. Beside these parameters, the timeout values or the operations (start, monitor, stop) are typical tuneables. Find more details in manual page `ocf_suse_SAPHanaTopology(7)`.

```

primitive rsc_SAPHanaCon_TST_HDB00 ocf:suse:SAPHanaController \
    op start interval="0" timeout="3600" \
    op stop interval="0" timeout="3600" \
    op promote interval="0" timeout="900" \
    op demote interval="0" timeout="320" \
    op monitor interval="60" role="Master" timeout="700" \
    op monitor interval="61" role="Slave" timeout="700" \
    params SID="TST" InstanceNumber="00" PREFER_SITE_TAKEOVER="true" \
    DUPLICATE_PRIMARY_TIMEOUT="7200" AUTOMATED_REGISTER="false" \
    HANA_CALL_TIMEOUT="120"

ms msl_SAPHanaCon_TST_HDB00 rsc_SAPHanaCon_TST_HDB00 \
    meta master-node-max="1" master-max="1" clone-node-max="1" interleave="true" \
    maintenance="true"

```

Add the configuration to the cluster.

```
# crm configure load update crm-saphanacon.txt
```

TABLE 2: TABLE DESCRIPTION OF IMPORTANT RESOURCE AGENT PARAMETER

Name	Description
PREFER_SITE_TAKEOVER	Defines whether RA should prefer to takeover to the secondary instance instead of restarting the failed primary locally. Set to true for SAPHanaSR-ScaleOut.

Name	Description
AUTOMATED_REGISTER	<p>Defines whether a former primary should be automatically registered to be secondary of the new primary. With this parameter you can adapt the level of system replication automation.</p> <p>If set to false, the former primary must be manually registered. The cluster will not start this SAP HANA RDBMS until it is registered to avoid double primary up situations.</p>
DUPLICATE_PRIMARY_TIMEOUT	<p>Time difference needed between two primary time stamps if a dual-primary situation occurs. If the time difference is less than the time gap, the cluster holds one or both sites in a "WAITING" status. This is to give an administrator the chance to react on a failover. If the complete node of the former primary crashed, the former primary will be registered after the time difference is passed. If "only" the SAP HANA RDBMS has crashed, then the former primary will be registered immediately. After this registration to the new primary, all data will be overwritten by the system replication.</p>

Additional information about all parameters can be found with the command `man ocf_suse_SAPHana_Controller`.

8.3.6 The virtual IP address of the HANA primary

The last mandatory resource to be added to the cluster is covering the virtual IP address for the HANA primary master name server. Replace the bold string with your instance number, SAP HANA system ID and the virtual IP address.

EXAMPLE 30: CONFIGURE THE VIRTUAL IP ADDRESS OF THE PRIMARY

```
# vi crm-vip.txt
```

Enter the following to *crm-vip.txt*:

```
primitive rsc_ip_<SID>_HDB<instanceNumber> ocf:heartbeat:IPAddr2 \  
  op monitor interval="10s" timeout="20s" \  
  params ip="<IP>"
```

EXAMPLE 31: REPLACE <SID> BY TST, <INSTANCENUMBER> BY 00, <IP> BY 192.7.7.20

```
primitive rsc_ip_TST_HDB00 ocf:heartbeat:IPAddr2 \  
  op monitor interval="10s" timeout="20s" \  
  params ip="192.7.7.20"
```

Load the file to the cluster.

```
# crm configure load update crm-vip.txt
```

In most installations, only the parameter **ip** needs to be set to the virtual IP address to be presented to the client systems. Use the command `man ocf_heartbeat_IPAddr2` for details on additional parameters.

8.3.7 Constraints

The constraints are organizing the correct placement of the virtual IP address for the client database access and the start order between the two resource agents SAPHanaController and SAPHanaTopology.

EXAMPLE 32: CONFIGURE NEEDED CONSTRAINTS

```
# vi crm-cs.txt
```

Enter the following to *crm-cs.txt*:

```
colocation col_saphana_ip_<SID>_HDB<instanceNumber> 2000:  
  rsc_ip_<SID>_HDB<instanceNumber>:Started \  
  msl_SAPHanaCon_<SID>_HDB<instanceNumber>:Master  
  
order ord_SAPHana_<SID>_HDB<instanceNumber> Optional:  
  cln_SAPHanaTop_<SID>_HDB<instanceNumber> \  
  msl_SAPHanaCon_<SID>_HDB<instanceNumber>  
  
location SAPHanaCon_not_on_majority_maker msl_SAPHanaCon_<SID>_HDB<instanceNumber> \  
  -inf: <majority maker>  
location SAPHanaTop_not_on_majority_maker cln_SAPHanaTop_<SID>_HDB<instanceNumber> \  
  -inf: <majority maker>
```

```
-inf: <majority maker>
```

EXAMPLE 33: REPLACE <SID> BY TST, <INSTANCENUMBER> BY 00

```
colocation col_saphana_ip_TST_HDB00 2000: rsc_ip_TST_HDB00:Started \  
    msl_SAPHanaCon_TST_HDB00:Master  
  
order ord_SAPHana_TST_HDB00 Optional: cln_SAPHanaTop_TST_HDB00 \  
    msl_SAPHanaCon_TST_HDB00  
  
location SAPHanaCon_not_on_majority_maker msl_SAPHanaCon_TST_HDB00 -inf: hanamm  
location SAPHanaTop_not_on_majority_maker cln_SAPHanaTop_TST_HDB00 -inf: hanamm
```

Load the file to the cluster.

```
# crm configure load update crm-cs.txt
```

8.3.8 The virtual IP address of the HANA read-enabled secondary

This optional resource is covering the virtual IP address for the read-enabled HANA secondary master name server. It is useful if SAP HANA is configured with the active/read-enabled feature. Replace the bold string with your instance number, SAP HANA system ID and the virtual IP address.



Note

In scale-out this works only for an SAP HANA topology with exactly one master name server and exactly one slave node.

EXAMPLE 34: CONFIGURE THE VIRTUAL IP ADDRESS OF THE READ-ENABLED SECONDARY

```
# vi crm-vip-ro.txt
```

Enter the following to *crm-vip-ro.txt*:

```
primitive rsc_ip_ro_<SID>_HDB<instanceNumber> ocf:heartbeat:IPaddr2 \  
    op monitor interval="10s" timeout="20s" \  
    params ip="<IP-ro>"  
colocation col_ip_ro_with_secondary_<SID>_HDB<instanceNumber> \  
    2000: rsc_ip_ro_<SID>_HDB<instanceNumber>:Started \  
    msl_SAPHanaCon_<SID>_HDB<instanceNumber>:Slave  
location loc_ip_ro_not_master_<SID>_HDB<instanceNumber> \  
    2000: rsc_ip_ro_<SID>_HDB<instanceNumber>:Started
```



```
rsc_ip_ro_<SID>_HDB<instanceNumber> \  
rule -inf: hana_<sid>_roles ne master1:master:worker:master
```

EXAMPLE 35: REPLACE <SID> BY TST, <INSTANCENUMBER> BY 00, <IP-RO> BY 192.168.201.161

```
primitive rsc_ip_ro_TST_HDB00 ocf:heartbeat:IPAddr2 \  
  op monitor interval="10s" timeout="20s" \  
  params ip="192.168.201.161" \  
colocation col_ip_ro_with_secondary_TST_HDB00 \  
  2000: rsc_ip_ro_TST_HDB00:Started \  
  ms1_SAPHanaCon_TST_HDB00:Slave \  
location loc_ip_ro_not_master_TST_HDB00 \  
  rsc_ip_ro_TST_HDB00 \  
  rule -inf: hana_tst_roles ne master1:master:worker:master
```

Load the file to the cluster.

```
# crm configure load update crm-vip-ro.txt
```

In most installations, only the parameter **ip** needs to be set to the virtual IP address to be presented to the client systems. Use the command `man ocf_heartbeat_IPAddr2` for details on additional parameters. See also manual page `SAPHanaSR-ScaleOut_basic_cluster(7)`.

8.4 Final steps

8.4.1 Verifying the communication between the hook and the cluster

Now check if the HA/DR provider could set the appropriate cluster attribute `hana_<sid>_glob_srHook`:

EXAMPLE 36: QUERY THE SRHOOK CLUSTER ATTRIBUTE

```
# crm_attribute -G -n hana_<sid>_glob_srHook
```

You should get an output similar to the following:

```
scope=crm_config name=hana_<sid>_glob_srHook value=SFAIL
```

In this case the HA/DR provider sets the attribute to `SFAIL` to inform the cluster about a broken system replication.

8.4.2 Using special virtual host names or FQHN during the installation of SAP HANA

If you have used special virtual host names or the fully qualified host name (FQHN) instead of the short node name, the resource agents need to map these names. To be able to match the short node name with the used SAP 'virtual host name', the saphostagent needs to report the list of installed instances correctly:

EXAMPLE 37: IN THE SETUP AT HAND THE VIRTUAL HOST NAME MATCHES THE NODE NAME

```
hanaso0:tstadm> /usr/sap/hostctrl/exe/saphostctrl -function ListInstances
Inst Info : HA1 - 00 - hanaso0 - 749, patch 418, changelist 1816226
```

8.4.3 Ending the cluster maintenance mode

After all changes, as last steps end the cluster maintenance mode, let the cluster detect the SAP HANA status and set the SAPHanaController resource out of maintenance.

EXAMPLE 38: ENDING THE CLUSTER MAINTENANCE

```
# crm maintenance off
# cs_wait_for_idle -s 5
# crm resource refresh msl_SAPHanaCon_TST_HDB00
# cs_wait_for_idle -s 5
# crm resource maintenance msl_SAPHanaCon_TST_HDB00 off
```

The command `cs_wait_for_idle` is part of the package `ClusterTools2`. For more details, see manual pages `cs_wait_for_idle(8)`, `crm(8)`, `SAPHanaSR_maintenance_examples(7)`.

9 Setup of a scale-out multi-target architecture



FIGURE 12: SECTION 3, "PLANNING THE INSTALLATION" (PAGE 9) [OSSETUP] [SAPHANAINST] [SAPHANAHSR] SECTION 7, "INTEGRATING SAP HANA WITH THE LINUX CLUSTER" (PAGE 37) SECTION 8, "CONFIGURING THE CLUSTER AND SAP HANA RESOURCES" (PAGE 44) MULTITARGET [TESTING]

This chapter is divided into two sections. Both are optional, depending on your needs.

- The first section describes the procedure to upgrade an existing scale-out performance optimized setup into a multi-target ready setup. It applies only if you plan to upgrade an existing not multi-target aware scale-out cluster.
- The second section is about configuring the 3rd site in a multi-target setup after freshly installing the whole landscape using the procedures mentioned in the document so far.

9.1 Upgrading an existing cluster of scale-out performance optimized HANA

This section applies only if you plan to upgrade an existing not multi-target aware scale-out cluster into a multi-target aware one. This is not the general approach. Usually you should start with a fresh installation for SAP HANA scale-out multi-target systems.

9.1.1 Prerequisites for the upgrade

For successful and smooth upgrade, you need the following prerequisites:

- SAP HANA supports multi-target system replication and HA/DR provider.
- All cluster nodes are online in the cluster and there are no current errors in the cluster or HANA.
- Package SAPHanaSR-ScaleOut of identical new version installed on all nodes, including majority maker.
- Resource agents SAPHanaController and SAPHanaTopology new and identical on all nodes, including majority maker.
- HA/DR provider hook script SAPHanaSrMultiTarget.py new and identical on all nodes, including majority maker.
- Sufficient sudoers permission on all nodes, including majority maker.
- Correct and identical entries for HA/DR provider in global.ini at both sites
- During upgrade the resources SAPHanaController and SAPHanaTopology need to be set into maintenance. HANA needs to reload its HA/DR provider configuration and hook scripts.
- The procedure has been successfully tested on a test system before applying it to the production system.

The upgrade will remove the global srHook attribute. Instead it will introduce site-specific attributes. Values for srHook attributes are written only on HANA srConnectionChanged() event. So the new attribute for HANA secondary site might stay empty in case HANA is not reloaded after the upgrade. In that case the polling attribute sync_state represents HANA's system replication status as fallback.

SAPHanaSR-manageAttr will always check prerequisites before changing the CIB attribute from one common hana_<sid>_glob_srHook to site-specific attributes hana_<sid>_site_srHook_<SITE>. By calling "SAPHanaSR-manageAttr -check ..." you can run that built-in check before trying an upgrade.

See manual pages SAPHanaSR-manageAttr(8) and SAPHanaSrMultiTarget.py(7) for details.

9.1.2 Upgrade procedures

At a glance the upgrade procedure looks like this:

- Initially check if everything looks fine.
- Set SUSE Linux Enterprise High Availability Extension cluster resources SAPHanaController and SAPHanaTopology into maintenance.
- Install multi-target aware SAPHanaSR-ScaleOut package on all nodes.
- Adapt sudoers permission on all nodes.
- Replace HANA HA/DR provider configuration on both sites.
- Check SUSE Linux Enterprise High Availability Extension and HANA HA/DR provider for matching defined upgrade entry state.
- Upgrade srHook attribute from old-style to multi-target.
- Check SUSE HA cluster for matching defined upgrade target state.
- Set SUSE HA cluster resources SAPHanaController and SAPHanaTopology from maintenance to managed.
- Finally check if everything looks fine.

As final result of this procedure, the RAs and hook script are upgraded from old-style to multi-target. Further the SUSE HA cluster's old-style global srHook attribute hana_<sid>_glob_srHook is replaced by site-aware attributes hana_<sid>_site_srHook_<SITE>. The new attrib-

utes might stay empty until HANA raises `srConnectionChanged()` events and triggers the new hook script for the first time. Further, the HANA global configuration and Linux sudoers permissions are adapted. New auxiliary SUSE HA cluster attributes are introduced

For more information, read the related blog article <https://www.suse.com/c/sap-hana-scale-out-multi-target-upgrade/>

9.2 Setup of third SAP HANA site in a multi-target architecture

This section applies only if you plan to attach a 3rd replication site to the existing multi-target aware cluster. This is a general approach. Nevertheless, a 3rd site could have been prepared already.

When the existing or newly created part of scale-out performance optimized cluster is ready, follow the steps below to configure the third SAP HANA site into multi-target.

9.2.1 Install SAP HANA at the third site

Follow the same steps as described in chapter [\[SAPHanaInst\]](#) for the secondary site. Make sure to use the identifiers for the third site, as defined in the parameter sheet.

9.2.2 Register the third site

Register the master node on the third site with the source of the SAP HANA system replication. In our case the source is the primary site with its respective primary master name server. Use the third site's site name as noted in the parameter sheet.

```
~> hdbnsutil -sr_register --name=FRA1 --remoteHost=hanaso0 --remoteInstance=00 --
replicationMode=async --operationMode=logreplay
```

9.2.3 Check SAPHanaSR attributes for the third site

SAPHanaSR-showAttr shows the status of the third site which should be as below:

```
hanaso0:~ # SAPHanaSR-showAttr
Global cib-time          maintenance prim sec  sync_state upd
-----
TST   Fri Jul 15 00:44:25 2022 false      WDF1 ROT1 SOK      ok
```

```

Sites lpt          lss mns          srHook srr
-----
FRA1                               SOK
ROT1 30           4  hanaso2 SOK   S
WDF1 1657838665 4  hanaso0 PRIM  P

Hosts  clone_state gra gsh node_state roles          score  site
-----
hanamm                               online
hanaso0 PROMOTED  2.0 2.2 online   master1:master:worker:master 150    WDF1
hanaso1 DEMOTED  2.0 2.2 online   slave:slave:worker:slave    -10000 WDF1
hanaso2 DEMOTED  2.0 2.2 online   master1:master:worker:master 100    ROT1
hanaso3 DEMOTED  2.0 2.2 online   slave:slave:worker:slave    -12200 ROT1

hanaso0:~ #

```

Important items in above output that may seem different from earlier hook output are:

- The “Glo(bal)” section shows the global “srHook” attribute that reflects the SAP HANA system replication status as reported by the HA/DR provider script. The attribute changes whenever SAP HANA raises an srConnectionChanged() event (and the Linux cluster is functional). This information helps to decide whether an SAP HANA takeover can be initiated in case the primary site fails. Only if the “srHook” attribute is “SOK”, the cluster will initiate a take-over. This “sync_state” attribute reflects the SAP HANA system replication status as reported by the SAPHanaController RA monitor. The RA sets this attribute whenever processing a monitor or probe action. The call is SAP HANA’s systemReplicationStatus.py. This happens on regular base, defined by the monitor interval, and on start/stop/promote/demote operations.
- The “Site” section “lss” column shows SAP HANA’s overall landscape status per site. The SAPHanaTopology RA monitor calls SAP HANA’s landscapeHostConfiguration.py script and updates this attribute accordingly. As long as SAP HANA does not report “lss” as “1”, no takeover will happen. A value of “0” indicates a fatal internal communication error that made it impossible to detect the current landscape status. The attribute “srr” indicates the detected system replication role. “P” is the abbreviation for “primary” and “S” for “secondary”. The SAPHanaTopology resource agent sets these values to allow operation in maintenance windows of SAP HANA. The attribute “mns” indicates the current identified active master names server of the site.
- In the “Hosts” section the “roles” column shows actual and configured roles for HANA on each node. Since we do not have standby nodes, actual and configured is always the same for a given host once SAP HANA is running. This output reflects the entries we made

in HANA's nameserver.ini file. The SAPHanaTopology RA updates these attributes during each monitor run. The majority maker has no SAP HANA roles at all. The "score" column shows what scores SAPHanaController uses for placing the roles, like primary SAP HANA master name server, primary worker and more on the right hosts.

10 Testing the cluster



FIGURE 13: SECTION 3, "PLANNING THE INSTALLATION" (PAGE 9) [OSSETUP] [SAPHANAINST] [SAPHANAHSR] SECTION 7, "INTEGRATING SAP HANA WITH THE LINUX CLUSTER" (PAGE 37) SECTION 8, "CONFIGURING THE CLUSTER AND SAP HANA RESOURCES" (PAGE 44) SECTION 9, "SETUP OF A SCALE-OUT MULTI-TARGET ARCHITECTURE" (PAGE 58) TESTING

Testing is one of the most important project tasks for implementing clusters. Proper testing is crucial. Make sure that all test cases derived from project or customer expectations are defined and passed completely. **Without testing the project is likely to fail in production use.**

The test prerequisite, if not described differently, is always that all cluster nodes are booted, are already normal members of the cluster and the SAP HANA RDBMS is running. The system replication is in state **SYNC** represented by 'srHook SOK' for the secondary site. The cluster is idle, no actions are pending, no migration constraints left over, no failcounts left over.

The expected results are given for SAPHanaController parameter `AUTOMATED_REGISTER="false"` and SBD parameter `SBD_START_MODE="always"`. These are installation defaults. Further `susChkSrv.py` parameter `action_on_lost="stop"` is used.

10.1 Generic cluster tests

The cluster tests described in this section cover the cluster reaction during operations. This includes starting and stopping the complete cluster or simulating SBD failures and much more.

- Parallel start of all cluster nodes (`crm cluster start` should be done in a short time frame).
- Stop of the complete cluster.

- Isolate ONE of the two SAP HANA sites.
- Power-off the majority maker.
- Isolate the SBD.
- Simulate a maintenance procedure with cluster continuously running.
- Simulate a maintenance procedure with cluster restart.
- Kill the corosync process of one of the cluster nodes.

10.2 Tests on the primary site

The tests described in this section are checking the reaction on several failures of the primary site. Of course, primary site always is where the SAP HANA primary is running. That site will change after most of this tests.

10.2.1 Tests regarding cluster nodes of the primary site

The tests listed here will check the SAP HANA and cluster reaction if one or more nodes of the primary site are failing.

- Power-off master name server of the primary.

Expected Observation: The cluster initiates a takeover. The master name server at secondary site gets promoted. The source of system replication to the DR site changes to the new primary site. The former primary site stays unregistered.

- Power-off the worker node but not the master name server of the primary.

Expected Observation: The cluster will fail to stop the remaining HANA instance and thus fence the primary master node. Then the cluster initiates a takeover. The master name server at secondary site gets promoted. The source of system replication to the DR site changes to the new primary site. The former primary site stays unregistered.

10.2.2 Tests regarding the complete primary site

This test category is simulating a complete site failure.

- Power off all nodes of the primary site in parallel.

Expected observation: The cluster initiates a takeover. The master name server at secondary site gets promoted. The source of system replication to the DR site changes to the new primary site. The former primary site stays unregistered.

- Manually registering a failed primary site as new secondary.

Prerequisites: A failed former primary sites has been manually registered. The exact site name has been used as already known to the cluster, see parameter sheet.

Expected observation: The cluster accepts the registered site as secondary. The HANA resources are looking fine. After a while, system replication for the new secondary site gets okay (srHook SOK).

10.2.3 Tests regarding the SAP HANA instances of the primary site

The tests listed here are checks about the SAP HANA and cluster reactions triggered by application failures such as a crashed SAP HANA instance.

- Kill the SAP HANA instance of the master name server of the primary.

Expected observation: Cluster notices the failure of monitor operation of the HANA resource and initiates a takeover to the secondary site. The master name server at secondary site gets promoted. The source of system replication to the DR site changes to the new primary site. The former primary site stays unregistered.

- Kill the SAP HANA instance of the worker node but not the master name server of the primary.

Expected observation: Cluster notices the failure of monitor operation of the HANA resource and initiates a takeover to the secondary site. The master name server at secondary site gets promoted. The source of system replication to the DR site changes to the new primary site. The former primary site stays unregistered.

- Kill **sapstartsrv** of any SAP HANA instance of the primary.

Expected observation: Cluster notices the failure of monitor operation of the HANA resource and initiates a takeover to the secondary site. The master name server at secondary site gets promoted. The source of system replication to the DR site changes to the new primary site. The former primary site stays unregistered.

- Kill **hdbindexserver** processes on the slave node of the primary.

Expected observation: SAP HANA HA/DR provider stops HANA instance. Cluster notices the failure of monitor operation of the HANA resource and initiates a takeover to the secondary site. The master name server at secondary site gets promoted. The source of system replication to the DR site changes to the new primary site. The former primary site stays unregistered.

- Kill **hdbindexserver** processes on the master name server node of the primary.

Expected observation: SAP HANA HA/DR provider stops HANA instance. Cluster notices the failure of monitor operation of the HANA resource and initiates a takeover to the secondary site. The master name server at secondary site gets promoted. The source of system replication to the DR site changes to the new primary site. The former primary site stays unregistered.

10.3 Tests on the secondary site

The tests described in this section are checking the reaction on several failures of the secondary site. Of course, secondary site always is where the SAP HANA secondary is running.

10.3.1 Tests regarding cluster nodes of the secondary site

The tests listed here will check the SAP HANA and cluster reaction if one or more nodes of the secondary site are failing.

- Power off master name server of the secondary.

Expected Observation: Cluster notices the power down of the master name server on secondary. System replication gets broken between primary and secondary.

- Power off the worker node but not the master name server of the secondary.

Expected observation: Cluster notices the power down of the worker node on secondary site. The remaining master name server will be stopped. System replication gets broken between primary and secondary.

- Rejoin of a previously powered-off worker node.

Expected observation: Cluster notices rejoining of previously powered-off node. The HANA instance gets started. System replication gets back to okay (srHook SOK).

- Kill **hdbindexserver** processes on the slave node of the secondary.

Expected observation: SAP HANA HA/DR provider stops HANA instance. Cluster notices the failure of monitor operation of the HANA resource and initiates a local restart of the secondary.

- Kill **hdbindexserver** processes on the master name server node of the secondary.

Expected observation: SAP HANA HA/DR provider stops HANA instance. Cluster notices the failure of monitor operation of the HANA resource and initiates a local restart of the secondary site.

10.3.2 Tests regarding the complete secondary site

This test category is simulating a complete site failure.

- Power off all nodes of the secondary site in parallel.

Expected observation: Cluster notices the nodes that are down. System replication gets broken (srHook SFAIL).

- Rebuild the secondary site.

Expected observation: Cluster notices the nodes that are back. HANA instance gets started. After a while, system replication for secondary site gets okay (srHook SOK).

10.3.3 Tests regarding the SAP HANA instances of the secondary site

The tests listed here are checks about the SAP HANA and cluster reactions triggered by application failures such as a crashed SAP HANA instance.

- Kill the SAP HANA instance of the master name server of the secondary.

Expected observation: Monitor operation on HANA resource on the master candidate at secondary gets failed. Cluster then restarts the HANA resource on the affected nodes.

- Kill the SAP HANA instance of the worker node but not the master name server of the secondary.

Expected observation: Monitor operation on HANA resource on the master candidate at secondary gets failed. Cluster then restarts the HANA resource on the affected nodes.

- Kill `sapstartsrv` of any SAP HANA instance of the secondary.

Expected observation: Monitor operation on HANA resource on the master name server at secondary gets failed. Cluster then restarts the HANA resource on the affected nodes.

10.4 Tests on the third site

The third site is not controlled by the Linux cluster. No failure on third site should trigger any cluster action. Only effect might be third site's `srHook` attribute changing from `SOK` to `SFAIL`, or vice versa.

10.4.1 Tests regarding the complete third site

This test category is simulating a complete site failure.

- Power off all nodes of the third site in parallel.

Expected observation: System replication for third site gets broken (`srHook SFAIL`).

- Rebuild the third site.

Expected observation: After a while, system replication for third site gets okay (`srHook SOK`).

11 Administration

11.1 Dos and don'ts

In your project, you should **do** the following:

- Define (and test) `STONITH` **before** adding other resources to the cluster.
- Do **intensive** testing.
- **Tune** the timeouts of operations of `SAPHanaController` and `SAPHanaTopology`.
- Start with `SAPHanaController` parameters `PREFER_SITE_TAKEOVER = true` , `AUTOMATED_REGISTER = false` and `DUPLICATE_PRIMARY_TIMEOUT = 7200`.

- Start with `susChkSrv.py` parameter `action_on_lost = stop`.
- Always make sure that the cluster configuration does not contain any left-over client-location constraints or failcounts.
- Before testing or beginning maintenance procedures, check if the cluster is in idle state.

In your project, **avoid** the following:

- Rapidly changing/changing back cluster configuration, such as: Setting nodes to standby and online again or stopping/starting the multi-state resource.
- Creating a cluster without proper time synchronization or unstable name resolutions for hosts, users, and groups.
- Adding location rules for the clone, multi-state or IP resource. Only location rules mentioned in this setup guide are allowed.
- Using SAP tools for attempting start/stop/takeover actions on a database while the cluster is in charge of managing that database. Same for unregistering/disabling system replication.
- As "migrating" or "moving" resources in `crm-shell`, HAWK or other tools would add client-location rules, these activities are completely **forbidden!**

11.2 Monitoring and tools

You can use the High Availability Web Konsole (HAWK), SAP HANA Cockpit and different command line tools for cluster status requests. See manual pages `crm_mon(8)`, `cs_wait_for_idle(8)`, `SAPHanaSR_maintenance_examples(7)`, `SAPHanaSR-showAttr(8)`, `SAPHanaSrMultiTarget.py(7)` and `susChkSrv.py(7)`.

11.2.1 HAWK – cluster status and more

You can use an Internet browser to check the cluster status. Use the following URL: <https://<node>:7630>

The login credentials are provided during the installation dialog of `ha-cluster-init`. Keep in mind to change the default password of the Linux user `hacluster`.

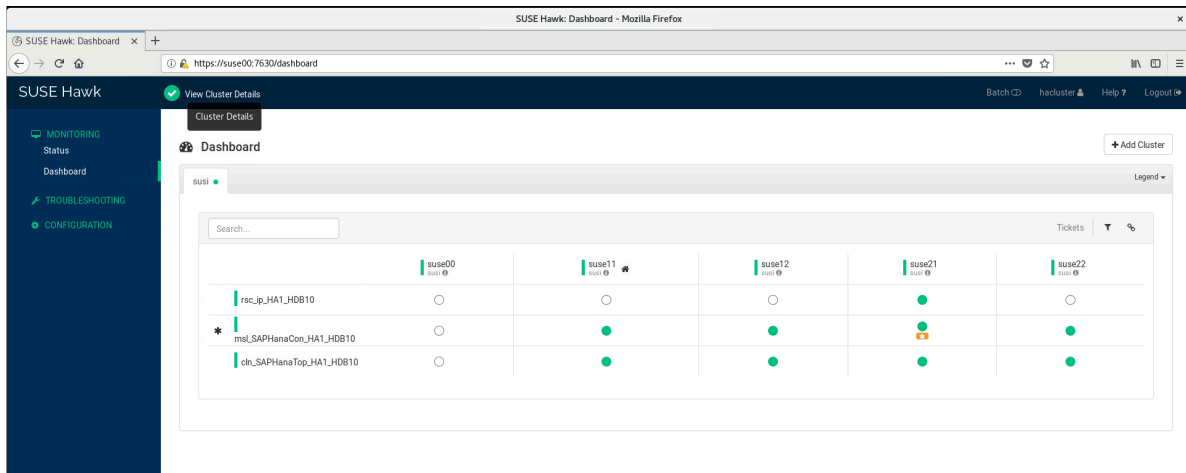

FIGURE 14: CLUSTER STATUS IN HAWK

If you set up the cluster using *ha-cluster-init* and you have installed all packages as described above, your system will provide a very useful Web interface. You can use this graphical Web interface to get an overview of the complete cluster status, perform administrative tasks or even configure resources and cluster bootstrap parameters.

Read the product manuals for a complete documentation of this powerful user interface.

11.2.2 SAP HANA Cockpit

Database-specific administration and checks can be done with SAP HANA Cockpit.

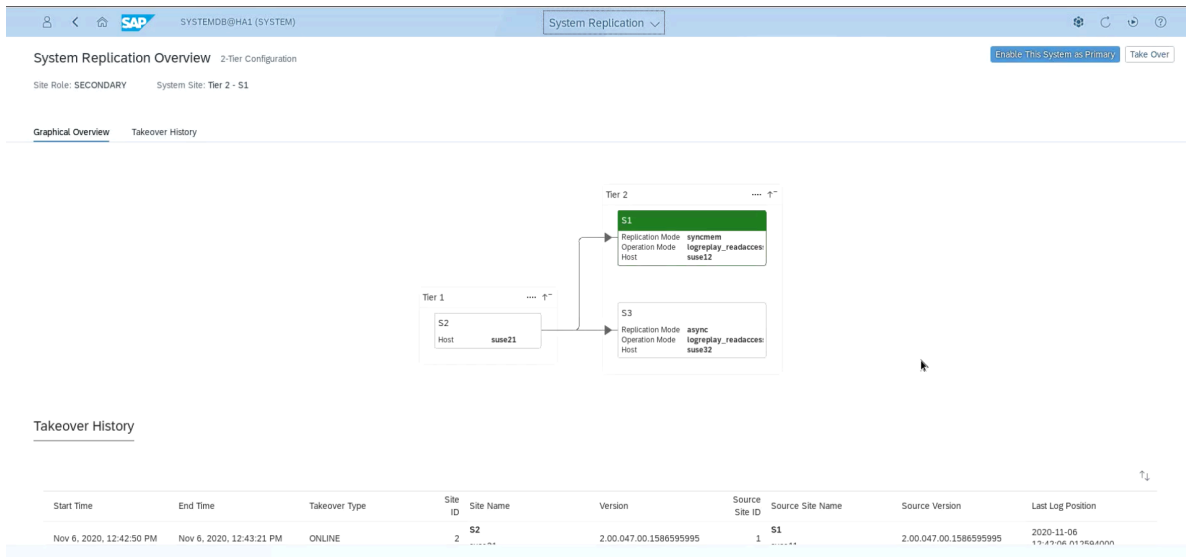

FIGURE 15: SAP HANA COCKPIT - SYSTEM REPLICATION OVERVIEW



Note

Be extremely careful with changing any parameter or the topology of the system replication. This might cause an interference with the cluster resource management.

A positive example is to register a former primary as new secondary and you have set `AUTOMATED_REGISTER=false`.

A negative example is to un-register a secondary, disable the system replication on the primary, and similar actions.

For all actions that change the system replication it is recommended to first check for the maintenance procedure. See manual page `SAPHanaSR_maintenance_examples(7)` and blog article <https://www.suse.com/c/sap-hana-maintenance-suse-clusters/> .

11.2.3 Cluster command line tools

`crm_mon`

A simple overview can be obtained by calling `crm_mon`. Using the option `-r` shows also stopped but already configured resources. Option `-1` tells `crm_mon` to output the status once instead of periodically.

```
Cluster Summary:
* Stack: corosync
* Current DC: hanaso1 (version
2.0.5+20201202.ba59be712-150300.4.21.1-2.0.5+20201202.ba59be712) - partition with quorum
* Last updated: Sat Aug  6 00:12:46 2022
* Last change:  Sat Aug  6 00:11:40 2022 by root via crm_attribute on hanaso0
* 5 nodes configured
* 12 resource instances configured

Node List:
* Online: [ hanamm hanaso0 hanaso1 hanaso2 hanaso3 ]

Active Resources:
* stonith-sbd (stonith:external/sbd):  Started hanamm
* Clone Set: cln_SAPHanaTop_TST_HDB00 [rsc_SAPHanaTop_TST_HDB00]:
  * Started: [ hanaso0 hanaso1 hanaso2 hanaso3 ]
* Clone Set: msl_SAPHanaCon_TST_HDB00 [rsc_SAPHanaCon_TST_HDB00] (promotable):
  * Masters: [ hanaso0 ]
  * Slaves: [ hanaso1 hanaso2 hanaso3 ]
* rsc_ip_TST_HDB00 (ocf::heartbeat:IPaddr2):          Started hanaso0
```

See manual page `crm_mon(8)` for details.

SAPHanaSR-showAttr

To show some SAPHanaController and SAPHanaTopology resource agent internal values, you can call the program `SAPHanaSR-showAttr`. The internal values, storage location and their parameter names may change in the next versions. The command `SAPHanaSR-showAttr` will always fetch the values from the correct storage location. Find more details and examples in manual page `SAPHanaSR-showAttr(8)`.

! Important

Do **not** use cluster commands like `crm_attribute` to fetch the values directly from the cluster. Your methods will be broken, when you need to move an attribute to a different storage location or even out of the cluster. `SAPHanaSR-showAttr` is firstly a test program only and should not be used for automated system monitoring.

EXAMPLE 39: CHECK SAPHANASR-SHOWATTR AS USER ROOT

```
suse-mm:~ # SAPHanaSR-showAttr --sid=<SID>
```

The tool displays all interesting cluster attributes in three areas.

- The **global** section shows information about SAP HANA SID, cib time stamp and a fall-back for the status of the system replication.
- The **site** section shows the attributes per site. It shows the system replication status as reported by SAP HANA HADR provider. Further it shows which site the primary and the return code of the `landscapeHostConfiguration.py` script. In addition the active master name server is shown.
- The **hosts** section shows the node status, the roles of the host inside the SAP HANA database, the calculated score to get the primary master name server and the site the host belongs to.

```
hanaso0:~ # SAPHanaSR-showAttr
Global cib-time          maintenance prim sec  sync_state upd
-----
TST   Fri Jul 15 00:44:25 2022 false      WDF1 ROT1 SOK      ok

Sites lpt          lss mns      srHook srr
-----
FRA1                SOK
```



```

ROT1 30      4  hanaso2 SOK  S
WDF1 1657838665 4  hanaso0 PRIM P

Hosts  clone_state gra gsh node_state roles          score  site
-----
hanamm                online
hanaso0 PROMOTED    2.0 2.2 online  master1:master:worker:master 150    WDF1
hanaso1 DEMOTED    2.0 2.2 online  slave:slave:worker:slave    -10000 WDF1
hanaso2 DEMOTED    2.0 2.2 online  master1:master:worker:master 100    ROT1
hanaso3 DEMOTED    2.0 2.2 online  slave:slave:worker:slave    -12200 ROT1

hanaso0:~ #

```

The majority maker *hanamm* does not run an SAP HANA instance and therefore neither has a role attribute nor a score or site value. The third HANA site FRA1 is not controlled by the Linux cluster. Therefore it doesnot have any attribute except the srHook status.

11.2.4 SAP HANA LandscapeHostConfiguration

To check the status of an SAP HANA database and to figure out if the cluster should react, you can use the script `landscapeHostConfiguration.py`.

EXAMPLE 40: CHECK THE LANDSCAPE STATUS AS USER <SID>ADM

```
~> HDBSettings.sh landscapeHostConfiguration.py
```

The landscape host configuration is shown with a line per SAP HANA host.

```

| Host   | Host   | ... NameServer | NameServer | IndexServer | IndexServer |
|        | Active | ... Config Role | Actual Role | Config Role | Actual Role |
| -----| -----| ... ----- | ----- | ----- | ----- |
| hanaso0 | yes   | ... master 1   | master     | worker      | master      |
| hanaso1 | yes   | ... slave     | slave      | worker      | slave      |

overall host status: ok

```

Following the SAP HA guideline, the *SAPHana* resource agent interprets the return codes in the following way:

TABLE 3: TABLE INTERPRETATION OF RETURN CODES

Return Code	Description
4	SAP HANA database is up and OK. The cluster does interpret this as correctly running database.

Return Code	Description
3	SAP HANA database is up and in status INFO. The cluster does interpret this as a correctly running database.
2	SAP HANA database is up and in status warning. The cluster does interpret this as a correctly running database.
1	SAP HANA database is down. If the database should be up and is not own by intention, this could trigger a takeover.
0	Internal Script Error – to be ignored.

11.3 Example for checking legacy SystemV integration

Check if the SAP hostagent is installed on all cluster nodes. As Linux user *root*, use the commands `systemctl` and `saphostctrl` to check the SAP hostagent:

```
# systemctl status sapinit
* sapinit.service - LSB: Start the sapstartsrv
   Loaded: loaded (/etc/init.d/sapinit; generated; vendor preset: disabled)
   Active: active (exited) since Wed 2022-02-09 17:25:36 CET; 3 weeks 0 days ago
     Docs: man:systemd-sysv-generator(8)
    Tasks: 0
   CGroup: /system.slice/sapinit.service
# /usr/sap/hostctrl/exe/saphostctrl -function ListInstances
Inst Info : TST - 00 - hanaso0 - 753, patch 819, changelist 2069355
```

The SystemV style `sapinit` is running and the hostagent recognises the installed database.

As Linux user `<sid>adm`, use the command line tool `HDB` to get an overview of running SAP HANA processes. The output of `HDB info` should be similar to the output shown below:

```
hanaso0:tstadm> HDB info
USER      PID     PPID   ... COMMAND
tstadm    13017   ...   -sh
tstadm    13072   ...   \_ /bin/sh /usr/sap/TST/HDB00/HDB info
tstadm    13103   ...   \_ ps fx -U tstadm -o
user:8,pid:8,ppid:8,pcpu:5,vsz:10,rss:10,args
tstadm    9268   ...   hdbrsutil --start --port 30003 --volume 2 --volumesuffix
mnt00001/hdb00002.00003 --identifier 1580897137
tstadm    8911   ...   hdbrsutil --start --port 30001 --volume 1 --volumesuffix
mnt00001/hdb00001 --identifier 1580897100
```

```
tstadm      8729    ... sapstart pf=/hana/shared/TST/profile/TST_HDB00_hanaso0
tstadm      8738    ... \_ /usr/sap/TST/HDB00/hanaso0/trace/hdb.sapTST_HDB00 -d -nw -
f /usr/sap/TST/HDB00/hanaso0/daemon.ini pf=/usr/sap/TST/SYS/profile/TST_HDB00_hanaso0
tstadm      8756    ... \_ hdbnameserver
tstadm      9031    ... \_ hdbcompileserver
tstadm      9034    ... \_ hdbpreprocessor
tstadm      9081    ... \_ hdbindexserver -port 30003
tstadm      9084    ... \_ hdbxsengine -port 30007
tstadm      9531    ... \_ hdbwebdispatcher
tstadm      8574    ... /usr/sap/TST/HDB00/exe/sapstartsrv pf=/hana/shared/TST/profile/
TST_HDB00_hanaso0 -D -u tstadm
```

12 References

For more detailed information, have a look at the documents listed below.

12.1 SUSE Product Documentation

Best Practices for SAP on SUSE Linux Enterprise

<https://documentation.suse.com/sbp/sap/> 

SUSE product manuals and documentation

<https://documentation.suse.com/> 

Release notes

<https://www.suse.com/releasenotes/> 

Online documentation of SLES for SAP

<https://documentation.suse.com/sles-sap/15-SP4/> 

Online documentation of SUSE Linux Enterprise High Availability Extension

<https://documentation.suse.com/sle-ha/15-SP4/single-html/SLE-HA-administration/#book-administration> 

Deployment guide for SUSE Linux Enterprise Server

<https://documentation.suse.com/sles/15-SP4/single-html/SLES-deployment/#book-deployment> 

Tuning guide for SUSE Linux Enterprise Server

<https://documentation.suse.com/sles/15-SP4/single-html/SLES-tuning/#book-tuning> 

Storage administration guide for SUSE Linux Enterprise Server

<https://documentation.suse.com/sles/15-SP4/single-html/SLES-storage/> 

SUSE Linux Enterprise Server Persistent Memory Guide

<https://documentation.suse.com/sles/15-SP4/html/SLES-all/cha-nvdim.html> 

SUSE Linux Enterprise kernel specs

https://www.suse.com/releasenotes/x86_64/SUSE-SLES/15-SP4/index.html#kernel-limits 

SUSE Linux Enterprise file system specs

https://www.suse.com/releasenotes/x86_64/SUSE-SLES/15-SP4/index.html#file-system-comparison 

XFS file system

<https://www.suse.com/c/xfs-the-file-system-of-choice/> ↗

SUSE YES certified hardware database

<https://www.suse.com/yessearch/> ↗

SUSE Manager Product Page

<https://www.suse.com/products/suse-manager/> ↗

SUSE Manager Documentation

<https://documentation.suse.com/external-tree/en-us/suma/4.1/suse-manager/index.html> ↗

RMT = Repository Mirroring Tool documentation

<https://documentation.suse.com/sles/15-SP4/html/SLES-all/book-rmt.html> ↗

SUSE Customer Center Frequently Asked Questions

<https://scc.suse.com/docs/help> ↗

12.2 Related Manual Pages

- [chronyc\(8\)](#)
- [corosync.conf\(8\)](#)
- [corosync_overview\(8\)](#)
- [crm\(8\)](#)
- [crm_mon\(8\)](#)
- [crm_simulate\(8\)](#)
- [cs_clusterstate\(8\)](#)
- [cs_man2pdf\(8\)](#)
- [cs_show_hana_info\(8\)](#)
- [cs_show_sbd_devices\(8\)](#)
- [cs_wait_for_idle\(8\)](#)
- [ha_related_sap_notes\(7\)](#)

- [ha_related_suse_tids\(7\)](#)
- [ocf_heartbeat_IPaddr2\(7\)](#)
- [ocf_heartbeat_SAPInstance\(7\)](#)
- [ocf_suse_SAPHana\(7\)](#)
- [ocf_suse_SAPHanaController\(7\)](#)
- [ocf_suse_SAPHanaTopology\(7\)](#)
- [SAPHanaSR\(7\)](#)
- [SAPHanaSR-filter\(8\)](#)
- [SAPHanaSR_basic_cluster\(7\)](#)
- [SAPHanaSR-hookHelper\(8\)](#)
- [SAPHanaSR_maintenance_examples\(7\)](#)
- [SAPHanaSR-manageAttr\(8\)](#)
- [SAPHanaSR-manageProvider\(8\)](#)
- [SAPHanaSR-monitor\(8\)](#)
- [SAPHanaSR-replay-archive\(8\)](#)
- [SAPHanaSR-ScaleOut\(7\)](#)
- [SAPHanaSR-ScaleOut_basic_cluster\(7\)](#)
- [SAPHanaSR-showAttr\(8\)](#)
- [SAPHanaSR-show-hadr-runtimes\(8\)](#)
- [SAPHanaSR.py\(7\)](#)
- [SAPHanaSrMultiTarget.py\(7\)](#)
- [saptune\(8\)](#)
- [sbd\(8\)](#)
- [stonith_sbd\(7\)](#)

- [sudo\(8\)](#)
- [sudoers\(5\)](#)
- [supportconfig\(8\)](#)
- [susChkSrv.py\(7\)](#)
- [susCostOpt.py\(7\)](#)
- [susTkOver.py\(7\)](#)
- [systemctl\(8\)](#)
- [systemd-cgls\(8\)](#)
- [votequorum\(5\)](#)
- [zypper\(8\)](#)

12.3 Related SUSE TIDs

SAP HANA SR Performance Optimized Scenario - Setup Guide - Errata

<https://www.suse.com/support/kb/doc?id=7023882> ↗

Estimate correct multipath timeout

<https://www.suse.com/support/kb/doc?id=7016305> ↗

Can't open watchdog device: /dev/watchdog: Device or resource busy

<https://www.suse.com/support/kb/doc?id=7008216> ↗

Systemd-udev-settle timing out

<https://www.suse.com/support/kb/doc?id=7022681> ↗

Configuring Persistent Memory Devices (PMEM) results in booting to the recovery shell

<https://www.suse.com/support/kb/doc?id=000019517> ↗

Slow boot boot initialization on machines with Intel Optane DC Memory causing auto-mount to fail

<https://www.suse.com/support/kb/doc?id=000019462> ↗

How to load the correct watchdog kernel module

<https://www.suse.com/support/kb/doc?id=7016880> ↗

TID XFS metadata corruption and invalid checksum on SAP Hana servers

<https://www.suse.com/support/kb/doc?id=7022921> ↗

Overcommit Memory in SLES

<https://www.suse.com/support/kb/doc?id=7002775> ↗

Recommended SUSE SLES 4 SAP Settings

<https://www.suse.com/support/kb/doc?id=7024082> ↗

SAPHanaController running in timeout when starting SAP Hana

<https://www.suse.com/support/kb/doc?id=000019899> ↗

Troubleshooting the SAPHanaSR python hook

<https://www.suse.com/support/kb/doc?id=000019865> ↗

Entry "CALLING CRM: ... rc=256" in HANA trace after upgrading SAPHanaSR-ScaleOut

<https://www.suse.com/support/kb/doc?id=000020599> ↗

SAP HANA monitors timed out after 5 seconds

<https://www.suse.com/support/kb/doc?id=000020626> ↗

HA cluster takeover takes too long on HANA indexserver failure

<https://www.suse.com/support/kb/doc?id=000020845> ↗

Cluster node fence as SAPHanaTopology fails with error code 1 (OCF_ERR_GENERIC) during a normal cluster stop

<https://www.suse.com/support/kb/doc?id=000020964> ↗

SUSE HA for HANA cluster node fenced at shutdown, despite of systemd integration

<https://www.suse.com/support/kb/doc?id=000021046> ↗

SAP HANA scale-out - pacemaker.service: "Cannot find sapstartsrv and sapcontrol executable, please set DIR_EXECUTABLE parameter!"

<https://www.suse.com/support/kb/doc?id=000021062> ↗

SAPHanaSR-showAttr fails with error "Error: NIECONN_REFUSED ..."

<https://www.suse.com/support/kb/doc?id=000020548> ↗

Protect HANA against manually caused dual-primary situation in SUSE HA cluster

<https://www.suse.com/support/kb/doc?id=000021044> ↗

Address space monitoring and HANA DB performance

<https://www.suse.com/support/kb/doc?id=000020746> ↗

HANA nodes end up having the same LPT values

<https://www.suse.com/support/kb/doc?id=000020690> ↗

HANA DB resource failed to start

<https://www.suse.com/support/kb/doc?id=000020948> ↗

SAPHanaController monitor timeout leads to database restart

<https://www.suse.com/support/kb/doc?id=000021249> ↗

HANA Database Planning Engine crashes in __strncmp_avx2_rtm+0x1b3

<https://www.suse.com/support/kb/doc?id=000021026> ↗

Basic health check for two-node SAP HANA performance based model

<https://www.suse.com/support/kb/doc?id=7022984> ↗

How to re-enable replication in a two-node SAP performance based model

<https://www.suse.com/support/kb/doc?id=7023127> ↗

Showing SOK Status in Cluster Monitoring Tools Workaround

<https://www.suse.com/support/kb/doc?id=7023526> ↗

HANA SystemReplication doesn't provide SiteName to Corosync Cluster

<https://www.suse.com/support/kb/doc?id=000019754> ↗

SUSE Cluster Support for SAP HANA System Replication Active / Active Read Enabled Feature

<https://www.suse.com/support/kb/doc?id=7023884> ↗

SAP Generating 'Database host operating system is not supported' alerts

<https://www.suse.com/support/kb/doc?id=7023744> ↗

sapstartsrv does not respawn after a forceful kill of the master nameserver

<https://www.suse.com/support/kb/doc?id=7024291> ↗

SAPHanaSR HANA system replication automation without layer 2 network

<https://www.suse.com/support/kb/doc?id=000020333> ↗

The vIP cluster resource does not follow the SAP HANA master ...

<https://www.suse.com/support/kb/doc?id=000019769> ↗

Handling failed NFS share in SUSE HA cluster for HANA system replication

<https://www.suse.com/support/kb/doc?id=000019904> ↗

SAP Instances failed stop on shutdown (PACEMAKER, SYSTEMD, SAP)

<https://www.suse.com/support/kb/doc?id=7022671> ↗

SAP on SLES shows Error: NIECONN_REFUSED in the logs

<https://www.suse.com/support/kb/doc?id=7023236> ↗

Indepth HANA Cluster Debug Data Collection (PACEMAKER, SAP)

<https://www.suse.com/support/kb/doc?id=7022702> ↗

How to prevent certain values in limits.conf from being changed by saptune

<https://www.suse.com/support/kb/doc?id=7023104> ↗

Disabling fstrim - under which conditions?

<https://www.suse.com/support/kb/doc?id=7023805> ↗

saptune: WARNING saptune.io.go:66: 'noop' is not a valid scheduler for device

<https://www.suse.com/support/kb/doc?id=000019572> ↗

How to patch a SAP Application Pacemaker Cluster

<https://www.suse.com/support/kb/doc?id=000020268> ↗

12.4 Related SUSE blogs

How to upgrade to SAPHanaSR-angi

<https://www.suse.com/c/how-to-upgrade-to-saphanasr-angi/> ↗

Emergency Braking for SAP HANA Dying Indexserver

<https://www.suse.com/c/emergency-braking-for-sap-hana-dying-indexserver/> ↗

SAP HANA Cockpit with SUSE HA integration greatly improves data integrity

<https://www.suse.com/c/sap-hana-cockpit-with-suse-ha-integration-greatly-improves-data-integrity/> ↗

Handover for the Next Round – SAP on SUSE Cluster and systemd Native Integration

<https://www.suse.com/c/handover-for-the-next-round-sap-on-suse-cluster-and-systemd-native-integration/> ↗

SAPHanaSR-ScaleOut for Multi-Target Architecture and Principles

<https://www.suse.com/c/saphanasr-scaleout-multi-target/> ↗

SAP HANA Scale-Out System Replication for large ERP Systems

<https://www.suse.com/c/sap-hana-scale-out-system-replication-for-large-erp-systems/> ↗

SAP HANA Cost-optimized – An alternative Route is available

<https://www.suse.com/c/sap-hana-cost-optimized-an-alternative-route-is-available/> ↗

Let's flip the flags! Is my SAP HANA database in sync or not?

<https://www.suse.com/c/lets-flip-the-flags-is-my-sap-hana-database-in-sync-or-not/> 

Entry to blog series #towardsZeroDowntime

<https://www.suse.com/c/tag/towardszerodowntime/> 

Fail-Safe Operation of SAP HANA: SUSE Extends Its High-Availability Solution

<http://scn.sap.com/community/hana-in-memory/blog/2014/04/04/fail-safe-operation-of-sap-hana-suse-extends-its-high-availability-solution> 

12.5 Related SAP Documentation

SAP Product Availability Matrix

https://support.sap.com/en/release-upgrade-maintenance.html#section_1969201630 

SAP HANA Installation and Update Guide

https://help.sap.com/doc/e9702d76c3284623b02de196c0e79e49/2.0.05/en-US/SAP_HANA_Server_Installation_Guide_en.pdf 

SAP HANA Administration Guide

https://help.sap.com/doc/eb75509ab0fd1014a2c6ba9b6d252832/2.0.05/en-US/SAP_HANA_Administration_Guide_en.pdf 

SAP HANA Documentation Entry Page

https://help.sap.com/viewer/product/SAP_HANA_PLATFORM/2.0.05/en-US 

SAP HANA Tailored Data Center Integration - FAQ

<https://www.sap.com/documents/2016/05/e8705aae-717c-0010-82c7-eda71af511fa.html> 

SAP HANA and Persistent Memory

<https://blogs.sap.com/2020/01/30/sap-hana-and-persistent-memory/> 

SAP HANA HA/DR Provider Hook Methods

<https://help.sap.com/viewer/6b94445c94ae495c83a19646e7c3fd56/2.0.05/en-US/5df2e766549a405e95de4c5d7f2efc2d.html> 

12.6 Related SAP Notes

611361 - Hostnames of SAP servers

<https://launchpad.support.sap.com/#/notes/611361> 

768727 - Automatic restart functions in sapstart for processes

<https://launchpad.support.sap.com/#/notes/768727> 

927637 - Web service authentication in sapstartsrv as of Release 7.00

<https://launchpad.support.sap.com/#/notes/927637> 

1092448 - IBM XL C/C++ runtime environment for Linux on system p

<https://launchpad.support.sap.com/#/notes/1092448> 

1514967 - SAP HANA: Central Note

<https://launchpad.support.sap.com/#/notes/1514967> 

1552925 - Linux: High Availability Cluster Solutions

<https://launchpad.support.sap.com/#/notes/1552925> 

1763512 - Support details for SUSE Linux Enterprise for SAP Applications

<https://launchpad.support.sap.com/#/notes/1763512> 

1846872 - "No space left on device" error reported from HANA

<https://launchpad.support.sap.com/#/notes/1846872> 

1876398 - Network configuration for System Replication in HANA SP6

<https://launchpad.support.sap.com/#/notes/1876398> 

1888072 - SAP HANA DB: Indexserver crash in strcmp sse42

<https://launchpad.support.sap.com/#/notes/1888072> 

2021789 - SAP HANA Revision and Maintenance Strategy

<https://launchpad.support.sap.com/#/notes/2021789> 

2196941 - SAP HANA Software Replication Takeover Hook Changes

<https://launchpad.support.sap.com/#/notes/2196941> 

2235581 - SAP HANA: Supported Operating Systems

<https://launchpad.support.sap.com/#/notes/2235581> 

2369981 - Required configuration steps for authentication with HANA System Replication

<https://launchpad.support.sap.com/#/notes/2369981> 

2369910 - SAP Software on Linux: General information

<https://launchpad.support.sap.com/#/notes/2369910> 

2380229 - SAP HANA Platform 2.0 - Central Note

<https://launchpad.support.sap.com/#/notes/2380229> 

2434562 - System Replication Hanging in Status "SYNCING" or "ERROR" With Status Detail "Missing Log" or "Invalid backup size"

<https://launchpad.support.sap.com/#/notes/2434562> 

2578899 - SUSE Linux Enterprise Server 15: Installation Note

<https://launchpad.support.sap.com/#/notes/2578899> 

2647673 - HANA Installation Failure

<https://launchpad.support.sap.com/#/notes/2647673> 

2684254 - SAP HANA DB: Recommended OS settings for SLES 15 / SLES for SAP Applications 15

<https://launchpad.support.sap.com/#/notes/2684254> 

2733483 - Host Auto-Failover Not Occur when Indexserver Crash on Worker Node

<https://launchpad.support.sap.com/#/notes/2733483> 

2750199 - Incorrect Alert Regarding Unsupported Operating System Version

<https://launchpad.support.sap.com/#/notes/2750199> 

2844322 - SAP HANA Platform 2.0 SPS 05 Release Note

<https://launchpad.support.sap.com/#/notes/2844322> 

2945239 - SAP HANA Platform 2.0 SPS 06 Release Note

<https://launchpad.support.sap.com/#/notes/2945239> 

3007062 - FAQ: SAP HANA & Third Party Cluster Solutions

<https://launchpad.support.sap.com/#/notes/3007062> 

3014176 - Applying System Size Dependent Resource Limits During Installation or Upgrade

<https://launchpad.support.sap.com/#/notes/3014176> 

3043459 - SAP HANA 2 SPS05 Revision 056.00

<https://launchpad.support.sap.com/#/notes/3043459> 

3072590 - Python 3 Support for Non-Productive SAP HANA Systems

<https://launchpad.support.sap.com/#/notes/3072590> 

3070359 - Python 3 Migration Guide For SAP HANA

<https://launchpad.support.sap.com/#/notes/3070359> 

3084229 - SAP HANA Python Support Scripts Fail due to Incompatibility With Python 3

<https://launchpad.support.sap.com/#/notes/3084229> 

3091152 - sapstartsrv - improved deregistration for UNIX/Linux

<https://launchpad.support.sap.com/#/notes/3091152> 

3093542 - Transition to Python 3 of the Python Distribution Delivered With SAP HANA 2.0 Server

<https://launchpad.support.sap.com/#/notes/3093542> 

3139184 - Linux: systemd integration for sapstartsrv and SAP Hostagent

<https://launchpad.support.sap.com/#/notes/3139184> 

3145200 - SAP Host Agent 7.22 PL57

<https://launchpad.support.sap.com/#/notes/3145200> 

12.7 Pacemaker

Pacemaker Project Documentation

<https://clusterlabs.org/pacemaker/doc/> 

13 Legal notice

Copyright © 2006–2024 SUSE LLC and contributors. All rights reserved.

Permission is granted to copy, distribute and/or modify this document under the terms of the GNU Free Documentation License, Version 1.2 or (at your option) version 1.3; with the Invariant Section being this copyright notice and license. A copy of the license version 1.2 is included in the section entitled "GNU Free Documentation License".

SUSE, the SUSE logo and YaST are registered trademarks of SUSE LLC in the United States and other countries. For SUSE trademarks, see <https://www.suse.com/company/legal/>.

Linux is a registered trademark of Linus Torvalds. All other names or trademarks mentioned in this document may be trademarks or registered trademarks of their respective owners.

Documents published as part of the SUSE Best Practices series have been contributed voluntarily by SUSE employees and third parties. They are meant to serve as examples of how particular actions can be performed. They have been compiled with utmost attention to detail. However, this does not guarantee complete accuracy. SUSE cannot verify that actions described in these documents do what is claimed or whether actions described have unintended consequences. SUSE LLC, its affiliates, the authors, and the translators may not be held liable for possible errors or the consequences thereof.

Below we draw your attention to the license under which the articles are published.

14 GNU Free Documentation License

Copyright © 2000, 2001, 2002 Free Software Foundation, Inc. 51 Franklin St, Fifth Floor, Boston, MA 02110-1301 USA. Everyone is permitted to copy and distribute verbatim copies of this license document, but changing it is not allowed.

0. PREAMBLE

The purpose of this License is to make a manual, textbook, or other functional and useful document "free" in the sense of freedom: to assure everyone the effective freedom to copy and redistribute it, with or without modifying it, either commercially or noncommercially. Secondly, this License preserves for the author and publisher a way to get credit for their work, while not being considered responsible for modifications made by others.

This License is a kind of "copyleft", which means that derivative works of the document must themselves be free in the same sense. It complements the GNU General Public License, which is a copyleft license designed for free software.

We have designed this License in order to use it for manuals for free software, because free software needs free documentation: a free program should come with manuals providing the same freedoms that the software does. But this License is not limited to software manuals; it can be used for any textual work, regardless of subject matter or whether it is published as a printed book. We recommend this License principally for works whose purpose is instruction or reference.

1. APPLICABILITY AND DEFINITIONS

This License applies to any manual or other work, in any medium, that contains a notice placed by the copyright holder saying it can be distributed under the terms of this License. Such a notice grants a world-wide, royalty-free license, unlimited in duration, to use that work under the conditions stated herein. The "Document", below, refers to any such manual or work. Any member of the public is a licensee, and is addressed as "you". You accept the license if you copy, modify or distribute the work in a way requiring permission under copyright law.

A "Modified Version" of the Document means any work containing the Document or a portion of it, either copied verbatim, or with modifications and/or translated into another language.

A "Secondary Section" is a named appendix or a front-matter section of the Document that deals exclusively with the relationship of the publishers or authors of the Document to the Document's overall subject (or to related matters) and contains nothing that could fall directly within that overall subject. (Thus, if the Document is in part a textbook of mathematics, a Secondary Section may not explain any mathematics.) The relationship could be a matter of historical connection with the subject or with related matters, or of legal, commercial, philosophical, ethical or political position regarding them.

The "Invariant Sections" are certain Secondary Sections whose titles are designated, as being those of Invariant Sections, in the notice that says that the Document is released under this License. If a section does not fit the above definition of Secondary then it is not allowed to be designated as Invariant. The Document may contain zero Invariant Sections. If the Document does not identify any Invariant Sections then there are none.

The "Cover Texts" are certain short passages of text that are listed, as Front-Cover Texts or Back-Cover Texts, in the notice that says that the Document is released under this License. A Front-Cover Text may be at most 5 words, and a Back-Cover Text may be at most 25 words.

A "Transparent" copy of the Document means a machine-readable copy, represented in a format whose specification is available to the general public, that is suitable for revising the document straightforwardly with generic text editors or (for images composed of pixels) generic paint programs or (for drawings) some widely available drawing editor, and that is suitable for input to text formatters or for automatic translation to a variety of formats suitable for input to text formatters. A copy made in an otherwise Transparent file format whose markup, or absence of markup, has been arranged to thwart or discourage subsequent modification by readers is not Transparent. An image format is not Transparent if used for any substantial amount of text. A copy that is not "Transparent" is called "Opaque".

Examples of suitable formats for Transparent copies include plain ASCII without markup, Texinfo input format, LaTeX input format, SGML or XML using a publicly available DTD, and standard-conforming simple HTML, PostScript or PDF designed for human modification. Examples of transparent image formats include PNG, XCF and JPG. Opaque formats include proprietary formats that can be read and edited only by proprietary word processors, SGML or XML for which the DTD and/or processing tools are not generally available, and the machine-generated HTML, PostScript or PDF produced by some word processors for output purposes only.

The "Title Page" means, for a printed book, the title page itself, plus such following pages as are needed to hold, legibly, the material this License requires to appear in the title page. For works in formats which do not have any title page as such, "Title Page" means the text near the most prominent appearance of the work's title, preceding the beginning of the body of the text.

A section "Entitled XYZ" means a named subunit of the Document whose title either is precisely XYZ or contains XYZ in parentheses following text that translates XYZ in another language. (Here XYZ stands for a specific section name mentioned below, such as "Acknowledgements", "Dedications", "Endorsements", or "History".) To "Preserve the Title" of such a section when you modify the Document means that it remains a section "Entitled XYZ" according to this definition. The Document may include Warranty Disclaimers next to the notice which states that this License applies to the Document. These Warranty Disclaimers are considered to be included by reference in this License, but only as regards disclaiming warranties: any other implication that these Warranty Disclaimers may have is void and has no effect on the meaning of this License.

2. VERBATIM COPYING

You may copy and distribute the Document in any medium, either commercially or noncommercially, provided that this License, the copyright notices, and the license notice saying this License applies to the Document are reproduced in all copies, and that you add no other conditions whatsoever to those of this License. You may not use technical measures to obstruct or control the reading or further copying of the copies you make or distribute. However, you may accept compensation in exchange for copies. If you distribute a large enough number of copies you must also follow the conditions in section 3.

You may also lend copies, under the same conditions stated above, and you may publicly display copies.

3. COPYING IN QUANTITY

If you publish printed copies (or copies in media that commonly have printed covers) of the Document, numbering more than 100, and the Document's license notice requires Cover Texts, you must enclose the copies in covers that carry, clearly and legibly, all these Cover Texts: Front-Cover Texts on the front cover, and Back-Cover Texts on the back cover. Both covers must also clearly and legibly identify you as the publisher of these copies. The front cover must present the full title with all words of the title equally prominent and visible. You may add other material on the covers in addition. Copying with changes limited to the covers, as long as they preserve the title of the Document and satisfy these conditions, can be treated as verbatim copying in other respects.

If the required texts for either cover are too voluminous to fit legibly, you should put the first ones listed (as many as fit reasonably) on the actual cover, and continue the rest onto adjacent pages.

If you publish or distribute Opaque copies of the Document numbering more than 100, you must either include a machine-readable Transparent copy along with each Opaque copy, or state in or with each Opaque copy a computer-network location from which the general network-using public has access to download using public-standard network protocols a complete Transparent copy of the Document, free of added material. If you use the latter option, you must take reasonably prudent steps, when you begin distribution of Opaque copies in quantity, to ensure that this Transparent copy will remain thus accessible at the stated location until at least one year after the last time you distribute an Opaque copy (directly or through your agents or retailers) of that edition to the public.

It is requested, but not required, that you contact the authors of the Document well before redistributing any large number of copies, to give them a chance to provide you with an updated version of the Document.

4. MODIFICATIONS

You may copy and distribute a Modified Version of the Document under the conditions of sections 2 and 3 above, provided that you release the Modified Version under precisely this License, with the Modified Version filling the role of the Document, thus licensing distribution and modification of the Modified Version to whoever possesses a copy of it. In addition, you must do these things in the Modified Version:

- A. Use in the Title Page (and on the covers, if any) a title distinct from that of the Document, and from those of previous versions (which should, if there were any, be listed in the History section of the Document). You may use the same title as a previous version if the original publisher of that version gives permission.
- B. List on the Title Page, as authors, one or more persons or entities responsible for authorship of the modifications in the Modified Version, together with at least five of the principal authors of the Document (all of its principal authors, if it has fewer than five), unless they release you from this requirement.
- C. State on the Title page the name of the publisher of the Modified Version, as the publisher.
- D. Preserve all the copyright notices of the Document.

- E. Add an appropriate copyright notice for your modifications adjacent to the other copyright notices.
- F. Include, immediately after the copyright notices, a license notice giving the public permission to use the Modified Version under the terms of this License, in the form shown in the Addendum below.
- G. Preserve in that license notice the full lists of Invariant Sections and required Cover Texts given in the Document's license notice.
- H. Include an unaltered copy of this License.
- I. Preserve the section Entitled "History", Preserve its Title, and add to it an item stating at least the title, year, new authors, and publisher of the Modified Version as given on the Title Page. If there is no section Entitled "History" in the Document, create one stating the title, year, authors, and publisher of the Document as given on its Title Page, then add an item describing the Modified Version as stated in the previous sentence.
- J. Preserve the network location, if any, given in the Document for public access to a Transparent copy of the Document, and likewise the network locations given in the Document for previous versions it was based on. These may be placed in the "History" section. You may omit a network location for a work that was published at least four years before the Document itself, or if the original publisher of the version it refers to gives permission.
- K. For any section Entitled "Acknowledgements" or "Dedications", Preserve the Title of the section, and preserve in the section all the substance and tone of each of the contributor acknowledgements and/or dedications given therein.
- L. Preserve all the Invariant Sections of the Document, unaltered in their text and in their titles. Section numbers or the equivalent are not considered part of the section titles.
- M. Delete any section Entitled "Endorsements". Such a section may not be included in the Modified Version.
- N. Do not retitle any existing section to be Entitled "Endorsements" or to conflict in title with any Invariant Section.
- O. Preserve any Warranty Disclaimers.

If the Modified Version includes new front-matter sections or appendices that qualify as Secondary Sections and contain no material copied from the Document, you may at your option designate some or all of these sections as invariant. To do this, add their titles to the list of Invariant Sections in the Modified Version's license notice. These titles must be distinct from any other section titles.

You may add a section Entitled "Endorsements", provided it contains nothing but endorsements of your Modified Version by various parties—for example, statements of peer review or that the text has been approved by an organization as the authoritative definition of a standard.

You may add a passage of up to five words as a Front-Cover Text, and a passage of up to 25 words as a Back-Cover Text, to the end of the list of Cover Texts in the Modified Version. Only one passage of Front-Cover Text and one of Back-Cover Text may be added by (or through arrangements made by) any one entity. If the Document already includes a cover text for the same cover, previously added by you or by arrangement made by the same entity you are acting on behalf of, you may not add another; but you may replace the old one, on explicit permission from the previous publisher that added the old one.

The author(s) and publisher(s) of the Document do not by this License give permission to use their names for publicity for or to assert or imply endorsement of any Modified Version.

5. COMBINING DOCUMENTS

You may combine the Document with other documents released under this License, under the terms defined in section 4 above for modified versions, provided that you include in the combination all of the Invariant Sections of all of the original documents, unmodified, and list them all as Invariant Sections of your combined work in its license notice, and that you preserve all their Warranty Disclaimers.

The combined work need only contain one copy of this License, and multiple identical Invariant Sections may be replaced with a single copy. If there are multiple Invariant Sections with the same name but different contents, make the title of each such section unique by adding at the end of it, in parentheses, the name of the original author or publisher of that section if known, or else a unique number. Make the same adjustment to the section titles in the list of Invariant Sections in the license notice of the combined work.

In the combination, you must combine any sections Entitled "History" in the various original documents, forming one section Entitled "History"; likewise combine any sections Entitled "Acknowledgements", and any sections Entitled "Dedications". You must delete all sections Entitled "Endorsements".

6. COLLECTIONS OF DOCUMENTS

You may make a collection consisting of the Document and other documents released under this License, and replace the individual copies of this License in the various documents with a single copy that is included in the collection, provided that you follow the rules of this License for verbatim copying of each of the documents in all other respects.

You may extract a single document from such a collection, and distribute it individually under this License, provided you insert a copy of this License into the extracted document, and follow this License in all other respects regarding verbatim copying of that document.

7. AGGREGATION WITH INDEPENDENT WORKS

A compilation of the Document or its derivatives with other separate and independent documents or works, in or on a volume of a storage or distribution medium, is called an "aggregate" if the copyright resulting from the compilation is not used to limit the legal rights of the compilation's users beyond what the individual works permit. When the Document is included in an aggregate, this License does not apply to the other works in the aggregate which are not themselves derivative works of the Document.

If the Cover Text requirement of section 3 is applicable to these copies of the Document, then if the Document is less than one half of the entire aggregate, the Document's Cover Texts may be placed on covers that bracket the Document within the aggregate, or the electronic equivalent of covers if the Document is in electronic form. Otherwise they must appear on printed covers that bracket the whole aggregate.

8. TRANSLATION

Translation is considered a kind of modification, so you may distribute translations of the Document under the terms of section 4. Replacing Invariant Sections with translations requires special permission from their copyright holders, but you may include translations of some or all

Invariant Sections in addition to the original versions of these Invariant Sections. You may include a translation of this License, and all the license notices in the Document, and any Warranty Disclaimers, provided that you also include the original English version of this License and the original versions of those notices and disclaimers. In case of a disagreement between the translation and the original version of this License or a notice or disclaimer, the original version will prevail.

If a section in the Document is Entitled "Acknowledgements", "Dedications", or "History", the requirement (section 4) to Preserve its Title (section 1) will typically require changing the actual title.

9. TERMINATION

You may not copy, modify, sublicense, or distribute the Document except as expressly provided for under this License. Any other attempt to copy, modify, sublicense or distribute the Document is void, and will automatically terminate your rights under this License. However, parties who have received copies, or rights, from you under this License will not have their licenses terminated so long as such parties remain in full compliance.

10. FUTURE REVISIONS OF THIS LICENSE

The Free Software Foundation may publish new, revised versions of the GNU Free Documentation License from time to time. Such new versions will be similar in spirit to the present version, but may differ in detail to address new problems or concerns. See <http://www.gnu.org/copyleft/>. Each version of the License is given a distinguishing version number. If the Document specifies that a particular numbered version of this License "or any later version" applies to it, you have the option of following the terms and conditions either of that specified version or of any later version that has been published (not as a draft) by the Free Software Foundation. If the Document does not specify a version number of this License, you may choose any version ever published (not as a draft) by the Free Software Foundation.

ADDENDUM: How to use this License for your documents

Copyright (c) YEAR YOUR NAME.

Permission is granted to copy, distribute and/or modify this document under the terms of the GNU Free Documentation License, Version 1.2

or any later version published by the Free Software Foundation;
with no Invariant Sections, no Front-Cover Texts, and no Back-Cover Texts.
A copy of the license is included in the section entitled “GNU
Free Documentation License”.

If you have Invariant Sections, Front-Cover Texts and Back-Cover Texts, replace the “ with... Texts.” line with this:

with the Invariant Sections being LIST THEIR TITLES, with the
Front-Cover Texts being LIST, and with the Back-Cover Texts being LIST.

If you have Invariant Sections without Cover Texts, or some other combination of the three, merge those two alternatives to suit the situation.

If your document contains nontrivial examples of program code, we recommend releasing these examples in parallel under your choice of free software license, such as the GNU General Public License, to permit their use in free software.