



SUSE Linux Enterprise Server 15 SP6

Security and Hardening Guide

Security and Hardening Guide

SUSE Linux Enterprise Server 15 SP6

This guide introduces basic concepts of system security and describes the usage of security software included with the product, such as AppArmor, SELinux, or the auditing system. The guide also supports system administrators in hardening an installation.

Publication Date: January 30, 2025

<https://documentation.suse.com> 

Copyright © 2006–2025 SUSE LLC and contributors. All rights reserved.

Permission is granted to copy, distribute and/or modify this document under the terms of the GNU Free Documentation License, Version 1.2 or (at your option) version 1.3; with the Invariant Section being this copyright notice and license. A copy of the license version 1.2 is included in the section entitled “GNU Free Documentation License”.

For SUSE trademarks, see <https://www.suse.com/company/legal/>. All third-party trademarks are the property of their respective owners. Trademark symbols (®, ™ etc.) denote trademarks of SUSE and its affiliates. Asterisks (*) denote third-party trademarks.

All information found in this book has been compiled with utmost attention to detail. However, this does not guarantee complete accuracy. Neither SUSE LLC, its affiliates, the authors nor the translators shall be held liable for possible errors or the consequences thereof.

Contents

Preface [xxi](#)

- 1 Available documentation [xxi](#)
- 2 Improving the documentation [xxii](#)
- 3 Documentation conventions [xxiii](#)
- 4 Support [xxv](#)
Support statement for SUSE Linux Enterprise Server [xxv](#) • Technology
previews [xxvi](#)

1 Security and confidentiality [1](#)

- 1.1 Overview [1](#)
- 1.2 Passwords [2](#)
- 1.3 Backups [2](#)
- 1.4 System integrity [3](#)
- 1.5 File access [4](#)
- 1.6 Networking [4](#)
- 1.7 Software vulnerabilities [5](#)
- 1.8 Malware [6](#)
- 1.9 Important security tips [7](#)
- 1.10 Reporting security issues [8](#)

I AUTHENTICATION [9](#)

2 Authentication with PAM [10](#)

- 2.1 What is PAM? [10](#)
- 2.2 Structure of a PAM configuration file [11](#)

- 2.3 The PAM configuration of sshd 14
- 2.4 Configuration of PAM modules 16
 - pam_env.conf 16 • pam_mount.conf.xml 17 • limits.conf 17
- 2.5 Configuring PAM using pam-config 18
- 2.6 Manually configuring PAM 19
- 2.7 Configuring U2F keys for local login 19
 - Associating the U2F key with your account 19 • Updating the PAM configuration 20
- 2.8 More information 21
- 3 Using NIS 23**
- 3.1 Configuring NIS servers 23
 - Configuring a NIS master server 23 • Configuring a NIS slave server 28
- 3.2 Configuring NIS clients 29
- 4 Setting up authentication clients using YaST 31**
- 4.1 Configuring an authentication client with YaST 31
- 4.2 SSSD 31
 - Checking the status 32 • Caching 32
- 5 LDAP with 389 Directory Server 33**
- 5.1 Structure of an LDAP directory tree 33
- 5.2 Creating and managing a Docker container for 389 Directory Server 36
- 5.3 Installing 389 Directory Server 38
 - Setting up a new 389 Directory Server instance 38 • Creating a 389 Directory Server instance with a custom configuration file 39 • Creating a 389 Directory Server instance from a template 41 • Stopping and starting 389 Directory Server 42 • Configuring administrator credentials for local administration 43
- 5.4 Firewall configuration 44

- 5.5 Backing up and restoring 389 Directory Server 44
 - Backing up the LDAP server configuration 45 • Creating an offline backup of the LDAP database and restoring from it 45 • Creating an online backup of the LDAP database and restoring from it 46
 - 5.6 Managing LDAP users and groups 47
 - Querying existing LDAP users and groups 47 • Creating users and managing passwords 47 • Creating and managing groups 48 • Deleting users and groups, and removing users from groups 49
 - 5.7 Managing plug-ins 49
 - Unsupported plug-ins on 389 Directory Server 50
 - 5.8 Using SSSD to manage LDAP authentication 51
 - Unsupported password hashes and authentication schemes 54
 - 5.9 Migrating to 389 Directory Server from OpenLDAP 54
 - Testing migration from OpenLDAP 55 • Testing migration of OpenLDAP servers that use saslauthd 58 • Planning your migration 63
 - 5.10 Importing TLS server certificates and keys 64
 - 5.11 Setting up replication 66
 - Asynchronous writes 66 • Designing your topology 67 • Example replication topologies 67 • Terminology 69 • Configuring replication 70 • Monitoring and healthcheck 73 • Making backups 74 • Pausing and resuming replication 74 • Changelog max-age 75 • Removing a replica 75 • Limitations on replication of 389 Directory Server 76
 - 5.12 Synchronizing with Microsoft Active Directory 76
 - Planning your synchronization topology 76 • Prerequisites for Active Directory 77 • Prerequisites for 389 Directory Server 78 • Creating an agreement from Active Directory to 389 Directory Server 78
 - 5.13 More information 79
- ## 6 Network authentication with Kerberos 80
- 6.1 Conceptual overview 80

- 6.2 Kerberos terminology 80
- 6.3 How Kerberos works 82
 - First contact 82 • Requesting a service 83 • Mutual authentication 84 • Ticket granting—contacting all servers 84
- 6.4 User view of Kerberos 85
- 6.5 Installing and administering Kerberos 86
 - Kerberos network topology 87 • Choosing the Kerberos realms 88 • Setting up the KDC hardware 88 • Configuring time synchronization 89 • Configuring the KDC 90 • Configuring Kerberos clients 94 • Configuring remote Kerberos administration 97 • Creating Kerberos service principals 98 • Enabling PAM support for Kerberos 100 • Configuring SSH for Kerberos authentication 101 • Using LDAP and Kerberos 102
- 6.6 Kerberos and NFS 105
 - Group membership 106 • Performance and scalability 106 • Master KDC, multiple domains, and trust relationships 107
- 6.7 More information 108
- 7 Active Directory support 109**
- 7.1 Integrating Linux and Active Directory environments 109
- 7.2 Background information for Linux Active Directory support 110
 - Domain join 112 • Domain login and user homes 113 • Offline service and policy support 114
- 7.3 Configuring a Linux client for Active Directory 115
 - Choosing which YaST module to use for connecting to Active Directory 116 • Joining Active Directory using *User logon management* 116 • Joining Active Directory using *Windows domain membership* 121 • Checking Active Directory connection status 123
- 7.4 Logging in to an Active Directory domain 124
 - GDM 124 • Console login 124
- 7.5 Changing passwords 125

- 7.6 Active Directory certificate auto-enrollment 126
 - Configuring certificate auto-enrollment on the server 126 • Enable certificate auto-enrollment on the client 127

8 Setting up a freeRADIUS server 129

- 8.1 Installation and testing on SUSE Linux Enterprise Server 129

II LOCAL SECURITY 132

9 Physical security 133

- 9.1 System locks 133
- 9.2 Locking down the BIOS 134
- 9.3 Security via the boot loaders 135
- 9.4 Retiring Linux servers with sensitive data 135
 - scrub: disk overwrite utility 136
- 9.5 Restricting access to removable media 137
- 9.6 System protection with enforced USB device authorization via *USBGuard* 139
 - Installing USBGuard 139 • How to use USBGuard 140 • More information 141

10 Software management 143

- 10.1 Removing unnecessary software packages (RPMs) 143
- 10.2 Patching Linux systems 145
 - YaST Online Update 146 • Automatic Online Update 146 • Repository Mirroring Tool—RMT 146 • SUSE Manager 147

11 File management 149

- 11.1 Disk partitions 149
- 11.2 Modifying permissions of certain system files 149
- 11.3 Changing home directory permissions from 755 to 700 151

- 11.4 Default umask 152
 - Adjusting the default umask 153
- 11.5 SUID/SGID files 153
- 11.6 World-writable files 154
- 11.7 Orphaned or unowned files 155
- 12 Encrypting partitions and files 156**
- 12.1 Setting up an encrypted file system with YaST 156
 - Creating an encrypted partition during installation 157 • Creating an encrypted partition on a running system 158 • Encrypting the content of removable media 158
- 12.2 Encrypting files with GPG 159
- 12.3 Encrypting files with RAGE 160
 - Additional Resources 162
- 13 Storage encryption for hosted applications with cryptctl 163**
- 13.1 Setting up a **cryptctl** server 164
- 13.2 Setting up a **cryptctl** client 166
- 13.3 Configuring /etc/fstab for LUKS volumes 169
- 13.4 Checking partition unlock status using server-side commands 169
- 13.5 Unlocking encrypted partitions manually 170
- 13.6 Maintenance downtime procedure 170
- 13.7 Setting up an HA environment for cryptctl-server service 171
- 13.8 More information 175
- 14 User management 176**
- 14.1 Various account checks 176
 - Unlocked accounts 176 • Unused accounts 176

- 14.2 Enabling password aging 177
- 14.3 Stronger password enforcement 179
- 14.4 Password and login management with PAM 179
 - Password strength 180 • Restricting use of previous passwords 181 • Locking user accounts after too many login failures 182
- 14.5 Restricting root logins 183
 - Restricting local text console logins 183 • Restricting graphical session logins 185 • Restricting SSH logins 185
- 14.6 Restricting **sudo** users 186
- 14.7 Setting an inactivity timeout for interactive shell sessions 187
- 14.8 Preventing accidental denial of service 189
 - Example for restricting system resources 190
- 14.9 Displaying login banners 192
- 14.10 Connection accounting utilities 193
- 15 Restricting cron and at 195**
- 15.1 Restricting the cron daemon 195
- 15.2 Restricting the at scheduler 196
- 16 Spectre/Meltdown checker 198**
- 16.1 Using **spectre-meltdown-checker** 198
- 16.2 More information 200
- 17 Configuring security settings with YaST 201**
- 17.1 *Security overview* 201
- 17.2 *Predefined security configurations* 202
- 17.3 *Password settings* 203
- 17.4 *Boot settings* 203
- 17.5 *Login settings* 204

- 17.6 *User addition* 204
- 17.7 *Miscellaneous settings* 204
- 18 The Polkit authentication framework 206**
 - 18.1 Conceptual overview 206
 - The authentication agent 207 • Configuration of Polkit 207 • Polkit Utilities 207
 - 18.2 Authorization types 208
 - Implicit authorizations 208 • SUSE default privileges 209
 - 18.3 Querying privileges 209
 - 18.4 Modifying Polkit configuration 210
 - Overriding Polkit policy files 211 • Adding JavaScript authorization rules 212 • Modifying the SUSE default privileges 213
 - 18.5 Restoring the SUSE default privileges 213
- 19 Access control lists in Linux 214**
 - 19.1 Traditional file permissions 214
 - The setuid bit 215 • The setgid bit 215 • The sticky bit 216
 - 19.2 Advantages of ACLs 216
 - 19.3 Definitions 217
 - 19.4 Handling ACLs 217
 - ACL entries and file mode permission bits 218 • A directory with an ACL 219 • A directory with a default ACL 222 • The ACL check algorithm 224
 - 19.5 ACL support in applications 225
 - 19.6 More information 225
- 20 Intrusion detection with AIDE 226**
 - 20.1 Why use AIDE? 226
 - 20.2 Setting up an AIDE database 226

- 20.3 Local AIDE checks 229
- 20.4 System independent checking 230
- 20.5 More information 231

III NETWORK SECURITY 233

21 X Window System and X authentication 234

22 Securing network operations with OpenSSH 235

- 22.1 OpenSSH overview 235
- 22.2 Server hardening 238
- 22.3 Password authentication 240
- 22.4 Managing user and host encryption keys 240
 - Creating user SSH key pairs 241 • Creating SSH server host keys 243
- 22.5 Rotating host keys 244
- 22.6 Public key authentication 246
- 22.7 Passphrase-less public key authentication 247
- 22.8 OpenSSH certificate authentication 247
 - Setting up a new certificate authority 249 • Creating host certificates 251 • CA configuration for users 252 • Creating user certificates 253 • Revoking host keys 253
- 22.9 Automated public key logins with gnome-keyring 254
- 22.10 Automated public key logins with ssh-agent 254
 - Using **ssh-agent** in an X session 255
- 22.11 Changing an SSH private key passphrase 255
- 22.12 Retrieving a key fingerprint 255
- 22.13 Starting X11 applications on a remote host 256
- 22.14 Agent forwarding 257

- 22.15 **scp**—secure copy 257
- 22.16 **sftp**—secure file transfer 258
 - Using **sftp** 258 • Setting permissions for file uploads 259
- 22.17 Port forwarding (SSH tunneling) 260
- 22.18 More information 260
- 22.19 Stopping SSH brute force attacks with Fail2Ban 261
 - What is Fail2Ban? 261 • Using Fail2Ban to stop an SSH brute force attack 261

23 Masquerading and firewalls 264

- 23.1 Packet filtering with iptables 264
- 23.2 Masquerading basics 267
- 23.3 Firewalling basics 268
- 23.4 **firewalld** 269
 - Configuring the firewall with NetworkManager 270 • Configuring the firewall with YaST 270 • Configuring the firewall on the command line 271 • Accessing services listening on dynamic ports 276
- 23.5 Migrating from SuSEfirewall2 282
- 23.6 More information 284

24 Configuring a VPN server 285

- 24.1 Conceptual overview 285
 - Terminology 285 • VPN scenarios 286
- 24.2 Setting up a simple test scenario 289
 - Configuring the VPN server 289 • Configuring the VPN clients 290 • Testing the VPN example scenario 291
- 24.3 Setting up your VPN server using a certificate authority 292
 - Creating certificates 292 • Configuring the VPN server 293 • Configuring the VPN clients 295
- 24.4 Setting up a VPN server or client using YaST 296

24.5	More information	297
25	Managing a PKI with XCA, X certificate and key manager	298
25.1	Installing XCA	298
25.2	Creating a new PKI	298
	Creating a new root CA	299
	Creating a signed host certificate	300
	Revoking a certificate	300
26	Improving network security with sysctl variables	302
IV	REGULATIONS AND COMPLIANCE	305
27	Common Criteria	306
27.1	Introduction	306
27.2	Evaluation Assurance Level (EAL)	306
27.3	Generic guiding principles	307
27.4	More information	309
28	Enabling compliance with FIPS 140-3	311
28.1	FIPS overview	311
28.2	When to enable FIPS mode	311
28.3	Installing FIPS	312
28.4	Enabling FIPS mode	313
28.5	MD5 not supported in Samba/CIFS	314
28.6	More information	314

29	Payment Card Industry Data Security Standard (PCI DSS)	315
30	Hardening SUSE Linux Enterprise with STIG	316
V	CONFINING PRIVILEGES WITH APPARMOR	317
31	Introducing AppArmor	318
31.1	AppArmor components	318
31.2	Background information on AppArmor profiling	319
32	Getting started	320
32.1	Installing AppArmor	320
32.2	Enabling and disabling AppArmor	321
32.3	Choosing applications to profile	322
32.4	Building and modifying profiles	322
32.5	Updating your profiles	324
33	Immunizing programs	325
33.1	Introducing the AppArmor framework	326
33.2	Determining programs to immunize	328
33.3	Immunizing cron jobs	329
33.4	Immunizing network applications	329
	Immunizing web applications	331
	Immunizing network agents	333
34	Profile components and syntax	334
34.1	Breaking an AppArmor profile into its parts	335
34.2	Profile types	337
	Standard profiles	337
	Unattached profiles	338
	Local profiles	339
	Hats	339
	Change rules	339

- 34.3 Include statements 340
 - Abstractions 342 • Program chunks 342 • Tunables 342
- 34.4 Capability entries (POSIX.1e) 342
- 34.5 Network access control 343
- 34.6 Profile names, flags, paths, and globbing 344
 - Profile flags 345 • Using variables in profiles 346 • Pattern matching 347 • Namespaces 348 • Profile naming and attachment specification 348 • Alias rules 349
- 34.7 File permission access modes 349
 - Read mode (r) 350 • Write mode (w) 350 • Append mode (a) 350 • File locking mode (k) 350 • Link mode (l) 351 • Link pair 351 • Optional allow and file rules 351 • Owner conditional rules 352 • Deny rules 353
- 34.8 Mount rules 353
- 34.9 Pivot root rules 355
- 34.10 PTrace rules 356
- 34.11 Signal rules 356
- 34.12 Execute modes 357
 - Discrete profile execute mode (px) 358 • Discrete local profile execute mode (cx) 358 • Unconfined execute mode (ux) 358 • Unsafe exec modes 359 • Inherit execute mode (ix) 359 • Allow executable mapping (m) 359 • Named profile transitions 359 • Fallback modes for profile transitions 360 • Variable settings in execution modes 361 • safe and unsafe keywords 362
- 34.13 Resource limit control 363
- 34.14 Auditing rules 364
- 35 AppArmor profile repositories 366**
- 36 Building and managing profiles with YaST 367**
 - 36.1 Manually adding a profile 367

- 36.2 Editing profiles **368**
 - Adding an entry [370](#) • Editing an entry [374](#) • Deleting an entry [374](#)
- 36.3 Deleting a profile [374](#)
- 36.4 Managing AppArmor [374](#)
 - Changing AppArmor status [375](#) • Changing the mode of individual profiles [376](#)
- 37 Building profiles from the command line [377](#)**
 - 37.1 Checking the AppArmor status [377](#)
 - 37.2 Building AppArmor profiles [378](#)
 - 37.3 Adding or creating an AppArmor profile [379](#)
 - 37.4 Editing an AppArmor profile [379](#)
 - 37.5 Unloading unknown AppArmor profiles [379](#)
 - 37.6 Deleting an AppArmor profile [380](#)
 - 37.7 Two methods of profiling [380](#)
 - Stand-alone profiling [381](#) • Systemic profiling [381](#) • Summary of profiling tools [383](#)
 - 37.8 Important file names and directories [403](#)
- 38 Profiling your Web applications using ChangeHat [404](#)**
 - 38.1 Configuring Apache for mod_apparmor [405](#)
 - Virtual host directives [406](#) • Location and directory directives [406](#)
 - 38.2 Managing ChangeHat-aware applications [407](#)
 - With AppArmor's command line tools [407](#) • Adding hats and entries to hats in YaST [413](#)
- 39 Confining users with pam_apparmor [415](#)**
- 40 Managing profiled applications [416](#)**
 - 40.1 Reacting to security event rejections [416](#)

- 40.2 Maintaining your security profiles 416
 - Backing up your security profiles 416 • Changing your security profiles 417 • Introducing new software into your environment 417

- 41 Support 418**
- 41.1 Updating AppArmor online 418
- 41.2 Using the man pages 418
- 41.3 More information 420
- 41.4 Troubleshooting 420
 - How to react to odd application behavior? 420 • My profiles do not work anymore ... 420 • Resolving issues with Apache 424 • How to exclude certain profiles from the list of profiles used? 424 • Can I manage profiles for applications not installed on my system? 424 • How to spot and fix AppArmor syntax errors 424
- 41.5 Reporting bugs for AppArmor 425

- 42 AppArmor glossary 427**

- VI SELINUX 430**

- 43 Configuring SELinux 431**
- 43.1 Why use SELinux? 431
 - Support status 432 • Understanding SELinux components 432
- 43.2 SELinux policy overview 433
- 43.3 Installing SELinux packages 434
- 43.4 Installing an SELinux policy 434
- 43.5 Putting SELinux into permissive mode 435
- 43.6 Putting SELinux into enforcing mode 435
- 43.7 Configuring SELinux 436

43.8 Managing SELinux 438
Viewing the security context 438 • Selecting the SELinux mode 440 • Modifying SELinux context types 441 • Applying file contexts 442 • Configuring SELinux policies 444 • Working with SELinux modules 445

43.9 Troubleshooting 445

VII THE LINUX AUDIT FRAMEWORK 449

44 Understanding Linux audit 450

44.1 Introducing the components of Linux audit 452

44.2 Configuring the audit daemon 454

44.3 Controlling the audit system using **auditctl** 456

44.4 Passing parameters to the audit system 458

44.5 Understanding the audit logs and generating reports 461

Understanding the audit logs 461 • Generating custom audit reports 467

44.6 Querying the audit daemon logs with **ausearch** 474

44.7 Analyzing processes with **autrace** 477

44.8 Visualizing audit data 478

44.9 Relaying audit event notifications 480

45 Setting up the Linux audit framework 483

45.1 Determining the components to audit 484

45.2 Configuring the audit daemon 484

45.3 Enabling audit for system calls 486

45.4 Setting up audit rules 487

45.5 Configuring audit reports 489

45.6 Configuring log visualization 493

46 Introducing an audit rule set 495

46.1 Adding basic audit configuration parameters 496

46.2 Adding watches on audit log files and configuration files 496

46.3 Monitoring file system objects 497

46.4 Monitoring security configuration files and databases 499

46.5 Monitoring miscellaneous system calls 501

46.6 Filtering system call arguments 501

46.7 Managing audit event records using keys 504

47 Useful resources 506

A GNU licenses 508

Preface

1 Available documentation

Online documentation

Our documentation is available online at <https://documentation.suse.com>. Browse or download the documentation in various formats.



Note: Latest updates

The latest updates are usually available in the English-language version of this documentation.

SUSE Knowledgebase

If you run into an issue, check out the Technical Information Documents (TIDs) that are available online at <https://www.suse.com/support/kb/>. Search the SUSE Knowledgebase for known solutions driven by customer need.

Release notes

For release notes, see <https://www.suse.com/releasesnotes/>.

In your system

For offline use, the release notes are also available under `/usr/share/doc/release-notes` on your system. The documentation for individual packages is available at `/usr/share/doc/packages`.

Many commands are also described in their *manual pages*. To view them, run `man`, followed by a specific command name. If the `man` command is not installed on your system, install it with `sudo zypper install man`.

2 Improving the documentation

Your feedback and contributions to this documentation are welcome. The following channels for giving feedback are available:

Service requests and support

For services and support options available for your product, see <https://www.suse.com/support/>.

To open a service request, you need a SUSE subscription registered at SUSE Customer Center. Go to <https://scc.suse.com/support/requests>, log in, and click *Create New*.

Bug reports

Report issues with the documentation at <https://bugzilla.suse.com/>.

To simplify this process, click the *Report an issue* icon next to a headline in the HTML version of this document. This preselects the right product and category in Bugzilla and adds a link to the current section. You can start typing your bug report right away.

A Bugzilla account is required.

Contributions

To contribute to this documentation, click the *Edit source document* icon next to a headline in the HTML version of this document. This will take you to the source code on GitHub, where you can open a pull request.

A GitHub account is required.



Note: *Edit source document* only available for English

The *Edit source document* icons are only available for the English version of each document. For all other languages, use the *Report an issue* icons instead.

For more information about the documentation environment used for this documentation, see the repository's README.

Mail

You can also report errors and send feedback concerning the documentation to doc-team@suse.com. Include the document title, the product version, and the publication date of the document. Additionally, include the relevant section number and title (or provide the URL) and provide a concise description of the problem.

3 Documentation conventions

The following notices and typographic conventions are used in this document:

- `/etc/passwd`: Directory names and file names
- `PLACEHOLDER`: Replace `PLACEHOLDER` with the actual value
- `PATH`: An environment variable
- `ls`, `--help`: Commands, options, and parameters
- `user`: The name of a user or group
- `package_name`: The name of a software package
- `Alt`, `Alt-F1`: A key to press or a key combination. Keys are shown in uppercase as on a keyboard.
- `File`, `File > Save As`: menu items, buttons
- `AMD/Intel` This paragraph is only relevant for the AMD64/Intel 64 architectures. The arrows mark the beginning and the end of the text block. `◁`
- `IBM Z, POWER` This paragraph is only relevant for the architectures `IBM Z` and `POWER`. The arrows mark the beginning and the end of the text block. `◁`
- *Chapter 1, “Example chapter”*: A cross-reference to another chapter in this guide.
- Commands that must be run with `root` privileges. You can also prefix these commands with the `sudo` command to run them as a non-privileged user:

```
# command  
> sudo command
```

- Commands that can be run by non-privileged users:

```
> command
```

- Commands can be split into two or multiple lines by a backslash character (`\`) at the end of a line. The backslash informs the shell that the command invocation will continue after the end of the line:

```
> echo a b \  

```

```
c d
```

- A code block that shows both the command (preceded by a prompt) and the respective output returned by the shell:

```
> command  
output
```

- Notices



Warning: Warning notice

Vital information you must be aware of before proceeding. Warns you about security issues, potential loss of data, damage to hardware, or physical hazards.



Important: Important notice

Important information you should be aware of before proceeding.



Note: Note notice

Additional information, for example about differences in software versions.



Tip: Tip notice

Helpful information, like a guideline or a piece of practical advice.

- Compact Notices



Additional information, for example about differences in software versions.



Helpful information, like a guideline or a piece of practical advice.

4 Support

Find the support statement for SUSE Linux Enterprise Server and general information about technology previews below. For details about the product lifecycle, see <https://www.suse.com/lifecycle>.

If you are entitled to support, find details on how to collect information for a support ticket at <https://documentation.suse.com/sles-15/html/SLES-all/cha-adm-support.html>.

4.1 Support statement for SUSE Linux Enterprise Server

To receive support, you need an appropriate subscription with SUSE. To view the specific support offers available to you, go to <https://www.suse.com/support/> and select your product.

The support levels are defined as follows:

L1

Problem determination, which means technical support designed to provide compatibility information, usage support, ongoing maintenance, information gathering and basic troubleshooting using available documentation.

L2

Problem isolation, which means technical support designed to analyze data, reproduce customer problems, isolate a problem area and provide a resolution for problems not resolved by Level 1 or prepare for Level 3.

L3

Problem resolution, which means technical support designed to resolve problems by engaging engineering to resolve product defects which have been identified by Level 2 Support.

For contracted customers and partners, SUSE Linux Enterprise Server is delivered with L3 support for all packages, except for the following:

- Technology previews.
- Sound, graphics, fonts, and artwork.
- Packages that require an additional customer contract.

- Some packages shipped as part of the module *Workstation Extension* are L2-supported only.
- Packages with names ending in `-devel` (containing header files and similar developer resources) will only be supported together with their main packages.

SUSE will only support the usage of original packages. That is, packages that are unchanged and not recompiled.

4.2 Technology previews

Technology previews are packages, stacks, or features delivered by SUSE to provide glimpses into upcoming innovations. Technology previews are included for your convenience to give you a chance to test new technologies within your environment. We would appreciate your feedback. If you test a technology preview, please contact your SUSE representative and let them know about your experience and use cases. Your input is helpful for future development.

Technology previews have the following limitations:

- Technology previews are still in development. Therefore, they may be functionally incomplete, unstable, or otherwise *not* suitable for production use.
- Technology previews are *not* supported.
- Technology previews may only be available for specific hardware architectures.
- Details and functionality of technology previews are subject to change. As a result, upgrading to subsequent releases of a technology preview may be impossible and require a fresh installation.
- SUSE may discover that a preview does not meet customer or market needs, or does not comply with enterprise standards. Technology previews can be removed from a product at any time. SUSE does not commit to providing a supported version of such technologies in the future.

For an overview of technology previews shipped with your product, see the release notes at <https://www.suse.com/releasenotes> .

1 Security and confidentiality

This chapter introduces basic concepts of computer security. Threats and basic mitigation techniques are described. The chapter also provides references to other chapters, guides and Web sites with further information.

1.1 Overview

One main characteristic of Linux is its ability to handle multiple users at the same time (multi-user) and to allow these users to simultaneously perform tasks (multitasking) on the same computer. To users, there is no difference between working with data stored locally and data stored in the network.

Because of the multiuser capability, data from different users has to be stored separately to guarantee security and privacy. Also important is the ability to keep data available in spite of a lost or damaged data medium, for example a hard disk.

This chapter is primarily focused on confidentiality and privacy. But a comprehensive security concept includes a regularly updated, workable, and tested backup. Without a backup, restoring data after it has been tampered with or after a hardware failure is hard.

Use a *defense-in-depth* approach to security: Assume that no single threat mitigation can fully protect your systems and data, but multiple layers of defense make an attack much harder. Components of a defense-in-depth strategy can be the following:

- Hashing passwords (for example with PBKDF2, bcrypt, or scrypt) and salting them
- Encrypting data (for example with AES)
- Logging, monitoring, and intrusion detection
- Firewall
- Antivirus scanner
- Defined and documented emergency procedures
- Backups
- Physical security
- Audits, security scans, and intrusion tests

SUSE Linux Enterprise Server includes software that addresses the requirements of the list above. The following sections provide starting points for securing your system.

Find more details about hardening your system in *Book "Security and Hardening Guide"*.

1.2 Passwords

On a Linux system, only hashes of passwords are stored. Hashes are one-way algorithms which scramble data to a digital fingerprint that is hard to reverse.

The hashes are stored in the file `/etc/shadow`, which cannot be read by normal users. Because restoring passwords is possible with powerful computers, hashed passwords should not be visible to regular users.

The *National Institute of Standards and Technology (NIST)* publishes a guideline for passwords, which is available at <https://pages.nist.gov/800-63-3/sp800-63b.html#sec5>

For details about how to set a password policy, see *Section 17.3, "Password settings"*. For general information about authentication on Linux, see *Part I, "Authentication"*.

1.3 Backups

If your system is compromised, backups can be used to restore a prior system state. When bugs or accidents occur, backups can also be used to compare the current system against an older version. For production systems, it is important to take some backups off-site for cases like disasters (for example, off-site storage of tapes/recordable media, or off-site initiated).

For legal reasons, some firms and organizations must be careful about backing up too much information and holding it too long. If your environment has a policy regarding the destruction of old paper files, you might need to extend this policy to Linux backup tapes as well.

The rules about physical security of servers apply to backups as well. Additionally, it is advisable to encrypt backup data. This can be done either per individual backup archive or for the complete backup file system, if applicable. Should a backup medium ever be lost, for example, during transportation, the data is protected against unauthorized access. The same applies if a backup system itself is compromised. To some extent encryption also ensures the integrity of the backups. Keep in mind, however, that the appropriate people need to be able to decrypt backups in emergency situations. Also, the case that an encryption key itself is compromised and needs to be replaced should be considered.

If a system is known to be compromised or suspected to be compromised, then it is vital to determine the integrity status of backups. If a system compromise went undetected for a long period of time, then it is possible that backups already include manipulated configuration files or malicious programs. Keeping a long enough history of backups allows to inspect for possible unwarranted differences.

Even without any known security breach, a regular inspection of differences among important configuration files in backups can help with finding security issues (maybe even accidental misconfigurations). This approach is best suited for files and environments where the content does not change too frequently.

1.4 System integrity

If it is possible to physically access a computer, the firmware and boot process can be manipulated to gain access when an authorized person boots the machine. While not all computers can be locked into inaccessible rooms, your first step should be physically locking the server room. Also remember that disposing of old equipment must be handled in a secure manner. Securing the boot loader and restricting removable media also provide useful physical security. See [Chapter 9, Physical security](#) for more information.

Consider taking the following additional measures:

- Configure your system so it cannot be booted from a removable device.
- Protect the boot process with a UEFI password, Secure Boot, and a GRUB2 password.
- Linux systems are started by a boot loader that allows passing additional options to the booted kernel. You can prevent others from using such parameters during boot by setting an additional password for the boot loader. This is crucial to system security. Not only does the kernel itself run with `root` permissions, but it is also the first authority to grant `root` permissions at system start-up.

For more information about setting a password in the boot loader, see *Book "Administration Guide", Chapter 18 "The boot loader GRUB 2", Section 18.2.6 "Setting a boot password"*.

- Enable hard disk encryption. For more information, see [Chapter 12, Encrypting partitions and files](#).

- Use `cryptctl` to encrypt hosted storage. For more information, see [Chapter 13, Storage encryption for hosted applications with cryptctl](#).
- Use AIDE to detect any changes in your system configuration. For more information, see [Chapter 20, Intrusion detection with AIDE](#).

1.5 File access

Because of the *everything is a file* approach in Linux, file permissions are important for controlling access to most resources. This means that by using file permissions, you can define access to regular files, directories and hardware devices. By default, most hardware devices are only accessible for `root`. However, certain devices, for example serial ports, can be accessible for normal users.

As a general rule, always work with the most restrictive privileges possible for a given task. For example, it is definitely not necessary to be `root` to read or write e-mail. If the mail program has a bug, this bug could be exploited for an attack that acts with exactly the permissions of the program at the time of the attack. By following the above rule, minimize the possible damage. For details, see [Section 19.1, “Traditional file permissions”](#) and [Section 19.2, “Advantages of ACLs”](#).

AppArmor and SELinux allow you to set constraints for applications and users. For details, see [Part V, “Confining privileges with AppArmor”](#) and [Part VI, “SELinux”](#).

If there is a chance that hard disks could be accessed outside of the installed operating system, for example by booting a live system or removing the hardware, encrypt the data. SUSE Linux Enterprise Server allows you to encrypt partitions containing data and the operating system. For details, see [Chapter 12, Encrypting partitions and files](#).

1.6 Networking

Securing network services is a crucial task. Aim to secure as many layers of the *OSI model* as possible.

All communication should be authenticated and encrypted with up-to-date cryptographic algorithms on the transport or application layer. Use a Virtual Private Network (VPN) as an additional secure layer on physical networks.

SUSE Linux Enterprise Server provides many options for securing your network:

- Use `openssl` to create X509 certificates. These certificates can be used for encryption and authentication of many services. You can set up your own *certificate authority (CA)* and use it as a source of trust in your network. For details, see `man openssl`.
- At least parts of networks are exposed to the public Internet. Reduce attack surfaces by closing ports with firewall rules and by uninstalling or at least disabling services that are not required. For details, see *Chapter 23, Masquerading and firewalls*.
- Use OpenVPN to secure communication channels over insecure physical networks. For details, see *Chapter 24, Configuring a VPN server*.
- Use strong authentication for network services. For details, see *Part I, "Authentication"*.

1.7 Software vulnerabilities

Software vulnerabilities are issues in software that can be exploited to obtain unauthorized access or misuse systems. Vulnerabilities are especially critical if they affect remote services, such as HTTP servers. Computer systems are complex, therefore they always include certain vulnerabilities.

When such issues become known, they must be fixed in the software by software developers. The resulting update must then be installed by system administrators in a timely and safe manner on affected systems.

Vulnerabilities are announced on centralized databases, for example the *National Vulnerability Database*, which is maintained by the US government. You can subscribe to feeds to stay informed about newly discovered vulnerabilities. In some cases the problems induced by the bugs can be mitigated until a software update is provided. Vulnerabilities are assigned a *Common Vulnerabilities and Exposures (CVE)* number and a *Common Vulnerability Scoring System (CVSS)* score. The score helps identify the severity of vulnerabilities.

SUSE provides a feed of security advisories. It is available at <https://www.suse.com/en-us/support/update/>. There is also a list of security updates by CVE number available at <https://www.suse.com/support/security/>.



Note: Backports and version numbers

SUSE employs the practice of applying the important source code fixes onto older stable versions of software (*backporting*). Therefore, even if the version number of a software in SUSE Linux Enterprise Server is lower than that of the latest version number from the upstream project, the software version in SUSE Linux Enterprise Server may already contain the latest fixes for vulnerabilities.

For more information, see Book *“Upgrade Guide”, Chapter 7 “Backports of source code”*.

Administrators should be prepared for severe vulnerabilities in their systems. This includes hardening all computers as far as possible. Also, we recommend to have predefined procedures in place for quickly installing updates for severe vulnerabilities.

To reduce the damage of possible attacks, use restrictive file permissions. See [Section 19.1, “Traditional file permissions”](#).

Other useful links:

- <http://lists.opensuse.org/opensuse-security-announce/>, mailing list with openSUSE security announcements
- <https://nvd.nist.gov/>, the National Vulnerability Database
- <https://cve.mitre.org/>, MITRE's CVE database
- https://www.bsi.bund.de/SiteGlobals/Forms/Suche/BSI/Sicherheitswarnungen/Sicherheitswarnungen_Formular.html, German Federal Office for Information Security vulnerability feed
- <https://www.first.org/cvss/>, information about the Common Vulnerability Scoring System

1.8 Malware

Malware is software that is intended to interrupt the normal functioning of a computer or steal data. This includes viruses, worms, ransomware or rootkits. Sometimes malware uses software vulnerabilities to attack a computer. However, often it is accidentally executed by a user, especially when installing third-party software from unknown sources. SUSE Linux Enterprise Server provides an extensive list of programs (packages) in its download repositories. This reduces the

need to download third-party software. All packages provided by SUSE are signed. The package manager of SUSE Linux Enterprise Server checks the signatures of packages after the download to verify their integrity.

The command `rpm --checksig RPM_FILE` shows whether the checksum and the signature of a package are correct. You can find the signing key on the first DVD of SUSE Linux Enterprise Server and on most key servers worldwide.

You can use the ClamAV antivirus software to detect malware on your system. ClamAV can be integrated into several services, for example mail servers and HTTP proxies. This can be used to filter malware before it reaches the user.

Restrictive user privileges can reduce the risk of accidental code execution.

1.9 Important security tips

The following tips are a quick summary of the sections above:

- Stay informed about the latest security issues. Get and install the updated packages recommended by security announcements as quickly as possible.
- Avoid using `root` privileges whenever possible. Set restrictive file permissions.
- Only use encrypted protocols for network communication.
- Disable any network services you do not absolutely require.
- Conduct regular security audits. For example, scan your network for open ports.
- Monitor the integrity of files on your systems with `AIDE` (Advanced Intrusion Detection Environment).
- Take proper care when installing any third-party software.
- Check all your backups regularly.
- Check your log files, for example, with Logwatch.
- Configure the firewall to block all ports that are not explicitly whitelisted.
- Design your security measures to be redundant.
- Use encryption where possible, for example, for hard disks of mobile computers.

1.10 Reporting security issues

If you discover a security-related problem, first check the available update packages. If no update is available, write an e-mail to security@suse.de. Include a detailed description of the problem and the version number of the package concerned. We encourage you to encrypt e-mails with GPG.

You can find a current version of the SUSE GPG key at <https://www.suse.com/support/security/contact/>.

I Authentication

- 2 Authentication with PAM **10**
- 3 Using NIS **23**
- 4 Setting up authentication clients using YaST **31**
- 5 LDAP with 389 Directory Server **33**
- 6 Network authentication with Kerberos **80**
- 7 Active Directory support **109**
- 8 Setting up a freeRADIUS server **129**

2 Authentication with PAM

Linux uses PAM (pluggable authentication modules) in the authentication process as a layer that mediates between user and application. PAM modules are available on a system-wide basis, so they can be requested by any application. This chapter describes how the modular authentication mechanism works and how it is configured.

2.1 What is PAM?

System administrators and programmers often want to restrict access to certain parts of the system or to limit the use of certain functions of an application. Without PAM, applications must be adapted every time a new authentication mechanism, such as LDAP, Samba, or Kerberos, is introduced. However, this process is time-consuming and error-prone. One way to avoid these drawbacks is to separate applications from the authentication mechanism and delegate authentication to centrally managed modules. Whenever a newly required authentication scheme is needed, it is sufficient to adapt or write a suitable *PAM module* for use by the program in question. The PAM concept consists of:

- *PAM modules*, which are a set of shared libraries for a specific authentication mechanism.
- A *module stack* with of one or more PAM modules.
- A PAM-aware *service* which needs authentication by using a module stack or PAM modules. Usually a service is a familiar name of the corresponding application, like **login** or **su**. The service name **other** is a reserved word for default rules.
- *Module arguments*, with which the execution of a single PAM module can be influenced.
- A mechanism evaluating each *result* of a single PAM module execution. A positive value executes the next PAM module. The way a negative value is dealt with depends on the configuration: “no influence, proceed” up to “terminate immediately” and anything in between are valid options.

2.2 Structure of a PAM configuration file

PAM can be configured in two ways:

File based configuration (/etc/pam.conf)

The configuration of each service is stored in /etc/pam.conf. However, for maintenance and usability reasons, this configuration scheme is not used in SUSE Linux Enterprise Server.

Directory based configuration (/etc/pam.d/)

Every service (or program) that relies on the PAM mechanism has its own configuration file in the /etc/pam.d/ directory. For example, the service for sshd can be found in the /etc/pam.d/sshd file.

The files under /etc/pam.d/ define the PAM modules used for authentication. Each file consists of lines, which define a service, and each line consists of a maximum of four components:

```
TYPE CONTROL
MODULE_PATH MODULE_ARGS
```

The components have the following meaning:

TYPE

Declares the type of the service. PAM modules are processed as stacks. Different types of modules have different purposes. For example, one module checks the password, another verifies the location from which the system is accessed, and yet another reads user-specific settings. PAM knows about four different types of modules:

auth

Check the user's authenticity, traditionally by querying a password. However, this can also be achieved with a chip card or through biometrics (for example, fingerprints or iris scan).

account

Modules of this type check if the user has general permission to use the requested service. As an example, such a check should be performed to ensure that no one can log in with the user name of an expired account.

password

The purpose of this type of module is to enable the change of an authentication token. Usually this is a password.

session

Modules of this type are responsible for managing and configuring user sessions. They are started before and after authentication to log login attempts and configure the user's specific environment (mail accounts, home directory, system limits, etc.).

CONTROL

Indicates the behavior of a PAM module. Each module can have the following control flags:

required

A module with this flag must be successfully processed before the authentication may proceed. After the failure of a module with the required flag, all other modules with the same flag are processed before the user receives a message about the failure of the authentication attempt.

requisite

Modules having this flag must also be processed successfully, in much the same way as a module with the required flag. However, in case of failure a module with this flag gives immediate feedback to the user and no further modules are processed. In case of success, other modules are subsequently processed, like any modules with the required flag. The requisite flag can be used as a basic filter checking for the existence of certain conditions that are essential for a correct authentication.

sufficient

After a module with this flag has been successfully processed, the requesting application receives an immediate message about the success and no further modules are processed, provided there was no preceding failure of a module with the required flag. The failure of a module with the sufficient flag has no direct consequences, in the sense that any subsequent modules are processed in their respective order.

optional

The failure or success of a module with this flag does not have any direct consequences. This can be useful for modules that are only intended to display a message (for example, to tell the user that mail has arrived) without taking any further action.

include

If this flag is given, the file specified as argument is inserted at this place.

MODULE_PATH

Contains a full file name of a PAM module. It does not need to be specified explicitly, if the module is located in the default directory `/lib/security` (for all 64-bit platforms supported by SUSE® Linux Enterprise Server, the directory is `/lib64/security`).

MODULE_ARGS

Contains a space-separated list of options to influence the behavior of a PAM module, such as `debug` (enables debugging) or `nullok` (allows the use of empty passwords).

In addition, there are global configuration files for PAM modules under `/etc/security`, which define the exact behavior of these modules (examples include `pam_env.conf` and `time.conf`). Every application that uses a PAM module calls a set of PAM functions, which then process the information in the configuration files and return the result to the requesting application.

To simplify the creation and maintenance of PAM modules, common default configuration files for the types `auth`, `account`, `password`, and `session` modules have been introduced. These are retrieved from every application's PAM configuration. Updates to the global PAM configuration modules in `common-*` are thus propagated across all PAM configuration files without requiring the administrator to update every single PAM configuration file.

The global PAM configuration files are maintained using the `pam-config` tool. This tool automatically adds new modules to the configuration, changes the configuration of existing ones or deletes modules (or options) from the configurations. Manual intervention in maintaining PAM configurations is minimized or no longer required.



Note: 64-bit and 32-bit mixed installations

When using a 64-bit operating system, it is possible to also include a runtime environment for 32-bit applications. In this case, make sure that you also install the 32-bit version of the PAM modules.

2.3 The PAM configuration of sshd

Consider the PAM configuration of sshd as an example:

EXAMPLE 2.1: PAM CONFIGURATION FOR SSSH (/etc/pam.d/ssh)

```
#%PAM-1.0 ①

auth    requisite    pam_nologin.so          ②
auth    include      common-auth             ③
account requisite    pam_nologin.so          ②
account include      common-account          ③
password include      common-password         ③
session required     pam_loginuid.so         ④
session include      common-session          ③
session optional     pam_lastlog.so          silent noupdate showfailed ⑤
```

- ① Declares the version of this configuration file for PAM 1.0. This is merely a convention, but could be used in the future to check the version.
- ② Checks, if `/etc/nologin` exists. If it does, no user other than `root` may log in.
- ③ Refers to the configuration files of four module types: `common-auth`, `common-account`, `common-password`, and `common-session`. These four files hold the default configuration for each module type.
- ④ Sets the login UID process attribute for the process that was authenticated.
- ⑤ Displays information about the last login of a user.

By including the configuration files instead of adding each module separately to the respective PAM configuration, you automatically get an updated PAM configuration when an administrator changes the defaults. Formerly, you needed to adjust all configuration files manually for all applications when changes to PAM occurred or a new application was installed. Now the PAM configuration is made with central configuration files and all changes are automatically inherited by the PAM configuration of each service.

The first include file (`common-auth`) calls three modules of the `auth` type: `pam_env.so`, `pam_gnome_keyring.so` and `pam_unix.so`. See [Example 2.2, "Default configuration for the auth section \(common-auth\)"](#).

EXAMPLE 2.2: DEFAULT CONFIGURATION FOR THE auth SECTION (common-auth)

```
auth    required    pam_env.so              ①
auth    optional    pam_gnome_keyring.so   ②
auth    required    pam_unix.so            try_first_pass ③
```

- ① `pam_env.so` loads `/etc/security/pam_env.conf` to set the environment variables as specified in this file. It can be used to set the `DISPLAY` variable to the correct value, because the `pam_env` module knows about the location from which the login is taking place.
- ② `pam_gnome_keyring.so` checks the user's login and password against the GNOME key ring
- ③ `pam_unix` checks the user's login and password against `/etc/passwd` and `/etc/shadow`.

The whole stack of `auth` modules is processed before `sshd` gets any feedback about whether the login has succeeded. All modules of the stack having the `required` control flag must be processed successfully before `sshd` receives a message about the positive result. If one of the modules is not successful, the entire module stack is still processed and only then is `sshd` notified about the negative result.

When all modules of the `auth` type have been successfully processed, another include statement is processed, in this case, that in *Example 2.3, "Default configuration for the account section (common-account)"*. `common-account` contains only one module, `pam_unix`. If `pam_unix` returns the result that the user exists, `sshd` receives a message announcing this success and the next stack of modules (`password`) is processed, shown in *Example 2.4, "Default configuration for the password section (common-password)"*.

EXAMPLE 2.3: DEFAULT CONFIGURATION FOR THE `account` SECTION (`common-account`)

```
account required pam_unix.so try_first_pass
```

EXAMPLE 2.4: DEFAULT CONFIGURATION FOR THE `password` SECTION (`common-password`)

```
password requisite pam_cracklib.so
password optional pam_gnome_keyring.so use_authtok
password required pam_unix.so use_authtok nullok shadow try_first_pass
```

Again, the PAM configuration of `sshd` involves only an include statement referring to the default configuration for `password` modules located in `common-password`. These modules must successfully be completed (control flags `requisite` and `required`) whenever the application requests the change of an authentication token.

Changing a password or another authentication token requires a security check. This is achieved with the `pam_cracklib` module. The `pam_unix` module used afterward carries over any old and new passwords from `pam_cracklib`, so the user does not need to authenticate again after changing the password. This procedure makes it impossible to circumvent the checks carried out by `pam_cracklib`. Whenever the `account` or the `auth` type are configured to complain about expired passwords, the `password` modules should also be used.

EXAMPLE 2.5: DEFAULT CONFIGURATION FOR THE `session` SECTION (`common-session`)

```
session required pam_limits.so
session required pam_unix.so try_first_pass
session optional pam_umask.so
session optional pam_systemd.so
session optional pam_gnome_keyring.so auto_start only_if=gdm,gdm-password,lxdm,lightdm
session optional pam_env.so
```

As the final step, the modules of the `session` type (bundled in the `common-session` file) are called to configure the session according to the settings for the user in question. The `pam_limits` module loads the file `/etc/security/limits.conf`, which may define limits on the use of certain system resources. The `pam_unix` module is processed again. The `pam_umask` module can be used to set the file mode creation mask. Since this module carries the `optional` flag, a failure of this module would not affect the successful completion of the entire session module stack. The `session` modules are called a second time when the user logs out.

2.4 Configuration of PAM modules

Some PAM modules are configurable. The configuration files are located in `/etc/security`. This section briefly describes the configuration files relevant to the `sshd` example—`pam_env.conf` and `limits.conf`.

2.4.1 `pam_env.conf`

`pam_env.conf` can be used to define a standardized environment for users that is set whenever the `pam_env` module is called. With it, preset environment variables using the following syntax:

```
VARIABLE [DEFAULT=VALUE] [OVERRIDE=VALUE]
```

VARIABLE

Name of the environment variable to set.

[DEFAULT=<value>]

Default VALUE the administrator wants to set.

[OVERRIDE=<value>]

Values that may be queried and set by `pam_env`, overriding the default value.

A typical example of how `pam_env` can be used is the adaptation of the `DISPLAY` variable, which is changed whenever a remote login takes place. This is shown in [Example 2.6, “pam_env.conf”](#).

EXAMPLE 2.6: PAM_ENV.CONF

```
REMOTEHOST  DEFAULT=localhost          OVERRIDE=@{PAM_RHOST}
DISPLAY     DEFAULT=${REMOTEHOST}:0.0      OVERRIDE=${DISPLAY}
```

The first line sets the value of the `REMOTEHOST` variable to `localhost`, which is used whenever `pam_env` cannot determine any other value. The `DISPLAY` variable in turn contains the value of `REMOTEHOST`. Find more information in the comments in `/etc/security/pam_env.conf`.

2.4.2 pam_mount.conf.xml

The purpose of `pam_mount` is to mount user home directories during the login process, and to unmount them during logout in an environment where a central file server keeps all the home directories of users. With this method, it is not necessary to mount a complete `/home` directory where all the user home directories would be accessible. Instead, only the home directory of the user who is about to log in, is mounted.

After installing `pam_mount`, a template for `pam_mount.conf.xml` is available in `/etc/security`. The description of the elements can be found in the manual page `man 5 pam_mount.conf`. A basic configuration of this feature can be done with YaST. Select *Network Settings* > *Windows Domain Membership* > *Expert Settings* to add the file server. See *Book “Storage Administration Guide”, Chapter 20 “Samba”, Section 20.5 “Configuring clients”*.



Note: LUKS2 support

LUKS2 support was added to `cryptsetup` 2.0, and SUSE Linux Enterprise Server has included support for LUKS2 in `pam_mount` since SUSE Linux Enterprise Server 12 SP3.

2.4.3 limits.conf

System limits can be set on a user or group basis in `limits.conf`, which is read by the `pam_limits` module. The file allows you to set hard limits, which may not be exceeded, and soft limits, which may be exceeded temporarily. For more information about the syntax and the options, see the comments in `/etc/security/limits.conf`.

2.5 Configuring PAM using pam-config

The **pam-config** tool helps you configure the global PAM configuration files (`/etc/pam.d/common-*`) and several selected application configurations. For a list of supported modules, use the **pam-config --list-modules** command. Use the **pam-config** command to maintain your PAM configuration files. Add new modules to your PAM configurations, delete other modules or modify options to these modules. When changing global PAM configuration files, no manual tweaking of the PAM setup for individual applications is required.

A simple use case for **pam-config** involves the following:

1. **Auto-generate a fresh unix-style PAM configuration.** Let **pam-config** create the simplest possible setup which you can extend later on. The **pam-config --create** command creates a simple Unix authentication configuration. Pre-existing configuration files not maintained by **pam-config** are overwritten, but backup copies are kept as `*.pam-config-backup`.
2. **Add a new authentication method.** Adding a new authentication method (for example, SSSD) to your stack of PAM modules comes down to a simple **pam-config --add --sss** command. SSSD is added wherever appropriate across all `common-*-pc` PAM configuration files.
3. **Add debugging for test purposes.** To make sure the new authentication procedure works as planned, turn on debugging for all PAM-related operations. The **pam-config --add --sss-debug** command turns on debugging for SSSD-related PAM operations. Find the debugging output in the `systemd` journal (see *Book "Administration Guide", Chapter 21 "journalctl: query the systemd journal"*). To configure SSSD, refer to [Section 5.8, "Using SSSD to manage LDAP authentication"](#).
4. **Query your setup.** Before you finally apply your new PAM setup, check if it contains all the options you wanted to add. The **pam-config --query --MODULE** command lists both the type and the options for the queried PAM module.
5. **Remove the debug options.** Finally, remove the debug option from your setup when you are entirely satisfied with its performance. The **pam-config --delete --sss-debug** command turns off debugging for the `pam_ssh.so` module. In case you had debugging options added for other modules, use similar commands to turn these off.

For more information on the **pam-config** command and the options available, refer to the manual page of **pam-config(8)**.

2.6 Manually configuring PAM

If you prefer to manually create or maintain your PAM configuration files, make sure to disable `pam-config` for these files.

When you create your PAM configuration files from scratch using the `pam-config --create` command, it creates symbolic links from the `common-*` to the `common-*-pc` files. `pam-config` only modifies the `common-*-pc` configuration files. Removing these symbolic links effectively disables `pam-config`, because `pam-config` only operates on the `common-*-pc` files and these files are not put into effect without the symbolic links.



Warning: Include `pam_systemd.so` in configuration

If you are creating your own PAM configuration, make sure to include `pam_systemd.so` configured as `session optional`. Not including the `pam_systemd.so` can cause problems with `systemd` task limits. For details, refer to the man page of `pam_systemd.so`.

2.7 Configuring U2F keys for local login

To provide more security during local login, you can configure two-factor authentication using the `pam-u2f` framework and the U2F feature on YubiKeys and Security Keys.

To set up U2F on your system, you need to associate your key with your account. After that, configure your system to use the key. The procedure is described in the following sections.

2.7.1 Associating the U2F key with your account

To associate your U2F key with your account, proceed as follows:

1. Log in to your machine.
2. Insert your U2F key.
3. Create a directory for the U2F key configuration:

```
> sudo mkdir -p ~/.config/Yubico
```

4. Run the `pamu2fcfg` command that outputs configuration lines:

```
> sudo pamu2fcfg > ~/.config/Yubico/u2f_keys
```

5. When your device begins flashing, touch the metal contact to confirm the association.

We recommend using a backup U2F device, which you can set up by running the following commands:

1. Run:

```
> sudo pamu2fcfg -n >> ~/.config/Yubico/u2f_keys
```

2. When your device begins flashing, touch the metal contact to confirm the association.

You can move the output file from the default location to a directory that requires the `sudo` permission to modify the file to increase security. For example, move it to the `/etc` directory. To do so, follow the steps:

1. Create a directory in `/etc`:

```
> sudo mkdir /etc/Yubico
```

2. Move the created file:

```
> sudo mv ~/.config/Yubico/u2f_keys /etc/Yubico/u2f_keys
```



Note: Placing the `u2f_keys` in a non-default location

If you move the output file to a different directory than is the default (`$HOME/.config/Yubico/u2f_keys`), you need to add the path to the `/etc/pam.d/login` file as described in [Section 2.7.2, “Updating the PAM configuration”](#).

2.7.2 Updating the PAM configuration

After you have created the U2F keys configuration, you need to adjust the PAM configuration on your system.

1. Open the file `/etc/pam.d/login`.
2. Add the line `auth required pam_u2f.so` to the file as follows:

```
##PAM-1.0
auth      include      common-auth
```

auth	required	pam_u2f.so
account	include	common-account
password	include	common-password
session	optional	pam_keyinit.so revoke
session	include	common-session
#session	optional	pam_xauth.so

- If you placed the `u2f_keys` file in a different location than `$HOME/.config/Yubi-co/u2f_keys`, you need to use the `authfile` option in the `/etc/pam.d/login` PAM file as follows:

```
#%PAM-1.0
auth    requisite pam_nologin.so
auth    include    common-auth
auth    required pam_u2f.so authfile=<PATH_TO_u2f_keys>
...
```

where `<PATH_TO_u2f_keys>` is the absolute path to the `u2f_keys` file.

2.8 More information

In the `/usr/share/doc/packages/pam` directory after installing the `pam-doc` package, find the following additional documentation:

READMEs

In the top level of this directory, there is the `modules` subdirectory holding README files about the available PAM modules.

The Linux-PAM System Administrators' Guide

This document comprises everything that the system administrator should know about PAM. It discusses a range of topics, from the syntax of configuration files to the security aspects of PAM.

The Linux-PAM Module Writers' Manual

This document summarizes the topic from the developer's point of view, with information about how to write standard-compliant PAM modules.

The Linux-PAM Application Developers' Guide

This document comprises everything needed by an application developer who wants to use the PAM libraries.

The PAM manual pages

PAM and the individual modules come with manual pages that provide a good overview of the functionality of all the components.

3 Using NIS

When multiple Unix systems in a network access common resources, it becomes imperative that all user and group identities are the same for all machines in that network. The network should be transparent to users: their environments should not vary, regardless of which machine they are using. This can be done by NIS and NFS services. NFS distributes file systems over a network and is discussed in *Book "Storage Administration Guide", Chapter 19 "Sharing file systems with NFS"*.

NIS (Network Information Service) can be described as a database-like service that provides access to the contents of `/etc/passwd`, `/etc/shadow`, and `/etc/group` across networks. NIS can also be used for other purposes (making the contents of files like `/etc/hosts` or `/etc/services` available, for example), but this is beyond the scope of this introduction. People often refer to NIS as *YP*, because it works like the network's "yellow pages."

3.1 Configuring NIS servers

To distribute NIS information across networks, either install one single server (a *master*) that serves all clients, or NIS slave servers requesting this information from the master and relaying it to their respective clients.

- To configure just one NIS server for your network, proceed with [Section 3.1.1, "Configuring a NIS master server"](#).
- If your NIS master server needs to export its data to slave servers, set up the master server as described in [Section 3.1.1, "Configuring a NIS master server"](#) and set up slave servers in the subnets as described in [Section 3.1.2, "Configuring a NIS slave server"](#).

3.1.1 Configuring a NIS master server

To manage the NIS Server functionality with YaST, install the `yast2-nis-server` package by running the `zypper in yast2-nis-server` command as root. To configure a NIS master server for your network, proceed as follows:

1. Start *YaST* > *Network Services* > *NIS Server*.

2. If you need just one NIS server in your network or if this server is to act as the master for further NIS slave servers, select *Install and Set Up NIS Master Server*. YaST installs the required packages.



Tip: Already installed NIS server software

If NIS server software is already installed on your machine, initiate the creation of a NIS master server by clicking *Create NIS Master Server*.



FIGURE 3.1: NIS SERVER SETUP

3. Determine basic NIS setup options:
 - a. Enter the NIS domain name.
 - b. Define whether the host should also be a NIS client (enabling users to log in and access data from the NIS server) by selecting *This Host is also a NIS Client*.
 - c. If your NIS server needs to act as a master server to NIS slave servers in other subnets, select *Active Slave NIS Server Exists*.

The option *Fast Map Distribution* is only useful with *Active Slave NIS Servers Exist*. It speeds up the transfer of maps to the slaves.

- d. Select *Allow Changes to Passwords* to allow users in your network (both local users and those managed through the NIS server) to change their passwords on the NIS server (with the command `yppasswd`). This makes the options *Allow Changes to GECOS Field* and *Allow Changes to Login Shell* available. “GECOS” means that the users can also change their names and address settings with the command `ypchfn`. “Shell” allows users to change their default shell with the command `ypchsh` (for example, to switch from Bash to sh). The new shell must be one of the predefined entries in `/etc/shells`.
- e. Select *Open Port in Firewall* to have YaST adapt the firewall settings for the NIS server.



FIGURE 3.2: MASTER SERVER SETUP

- f. Leave this dialog with *Next* or click *Other Global Settings* to make additional settings. *Other Global Settings* include changing the source directory of the NIS server (`/etc` by default). In addition, passwords can be merged here. The setting should be *Yes* to create the user database from the system authentication files `/etc/passwd`, /

`etc/shadow` and `/etc/group`. Also, determine the smallest user and group ID that should be offered by NIS. Click *OK* to confirm your settings and return to the previous screen.

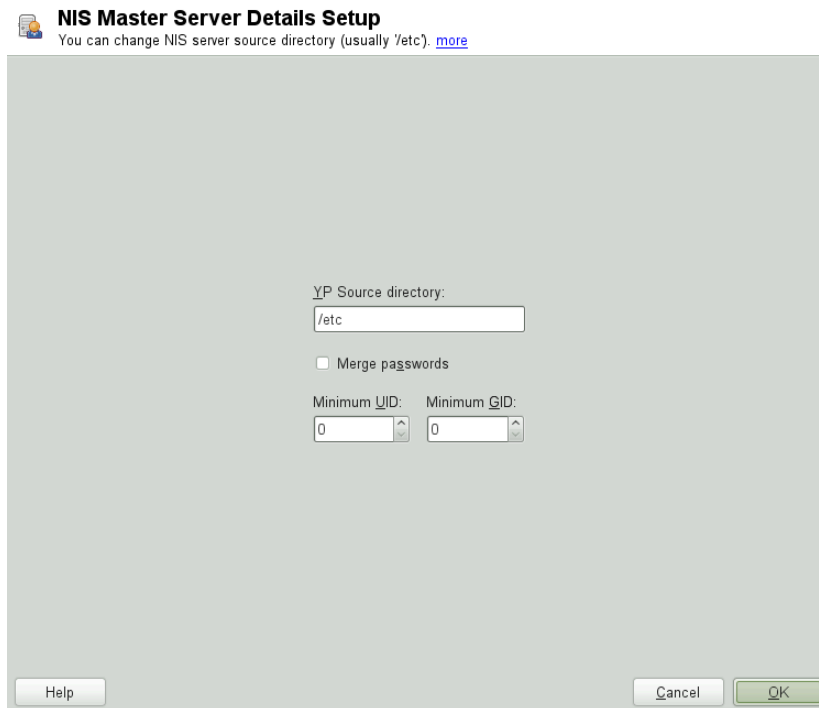

FIGURE 3.3: CHANGING THE DIRECTORY AND SYNCHRONIZING FILES FOR A NIS SERVER

4. If you previously enabled *Active Slave NIS Server Exists*, enter the host names used as slaves and click *Next*. If no slave servers exist, this configuration step is skipped.
5. Continue to the dialog for the database configuration. Specify the *NIS Server Maps*, the partial databases to transfer from the NIS server to the client. The default settings are adequate. Leave this dialog with *Next*.
6. Check which maps should be available and click *Next* to continue.

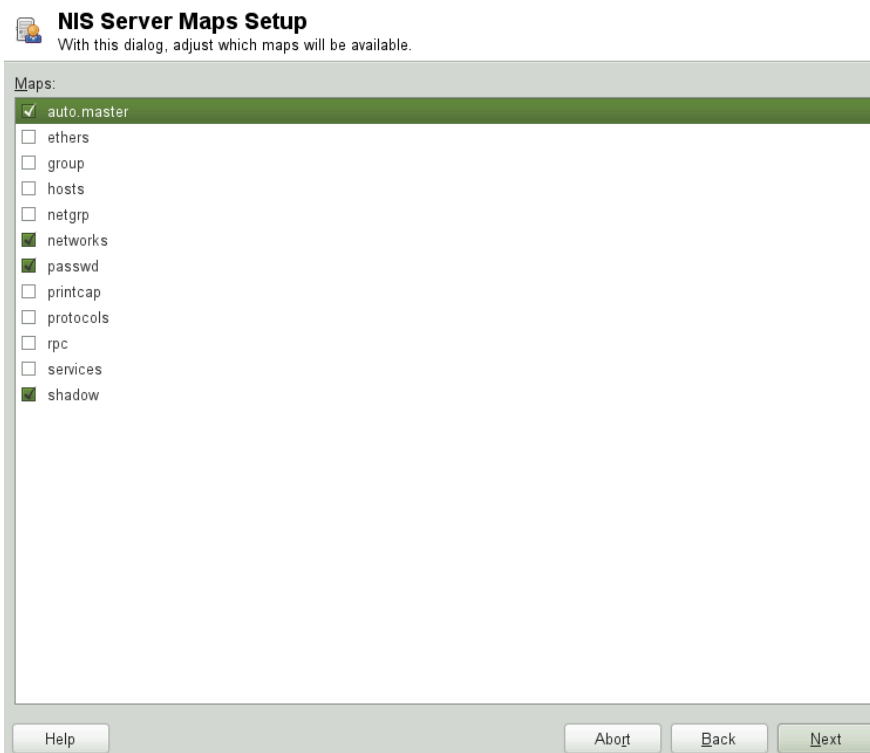

FIGURE 3.4: NIS SERVER MAPS SETUP

7. Determine which hosts are allowed to query the NIS server. You can add, edit, or delete hosts by clicking the appropriate button. Specify from which networks requests can be sent to the NIS server. Normally, this is your internal network. In this case, there should be the following two entries:

```
255.0.0.0    127.0.0.0
0.0.0.0     0.0.0.0
```

The first entry enables connections from your own host, which is the NIS server. The second one allows all hosts to send requests to the server.

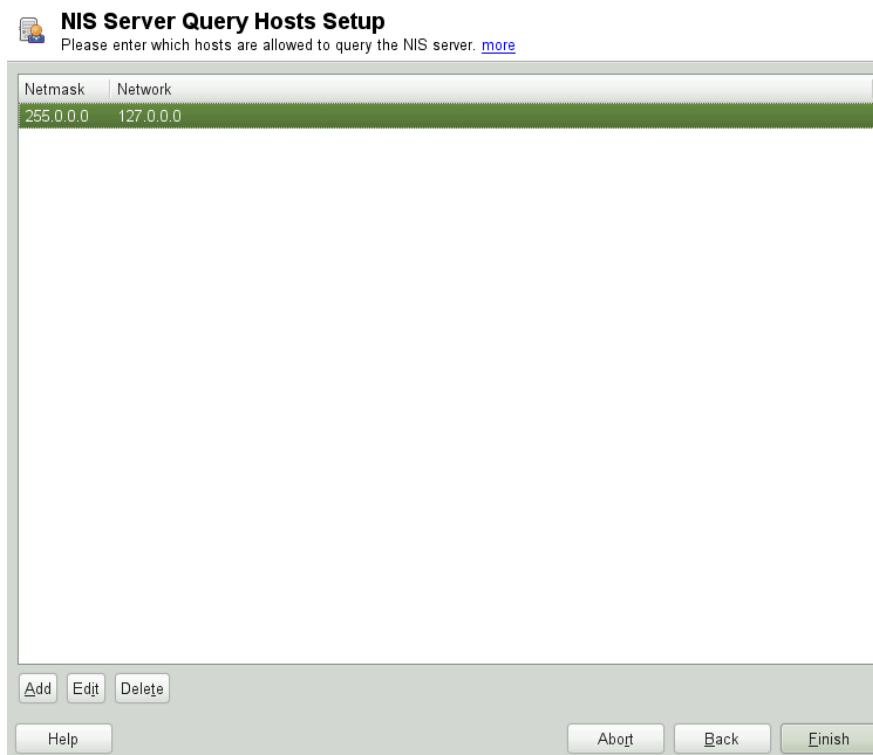

FIGURE 3.5: SETTING REQUEST PERMISSIONS FOR A NIS SERVER

8. Click *Finish* to save your changes and exit the setup.

3.1.2 Configuring a NIS slave server

To configure additional NIS *slave servers* in your network, proceed as follows:

1. Start *YaST > Network Services > NIS Server*.
2. Select *Install and Set Up NIS Slave Server* and click *Next*.



Tip

If NIS server software is already installed on your machine, initiate the creation of a NIS slave server by clicking *Create NIS Slave Server*.

3. Complete the basic setup of your NIS slave server:
 - a. Enter the NIS domain.

- b. Enter host name or IP address of the master server.
 - c. Set *This Host is also a NIS Client* to enable user logins on this server.
 - d. Adapt the firewall settings with *Open Ports in Firewall*.
 - e. Click *Next*.
4. Enter the hosts that are allowed to query the NIS server. You can add, edit, or delete hosts by clicking the appropriate button. Specify all networks from which requests can be sent to the NIS server. If it applies to all networks, use the following configuration:

```
255.0.0.0    127.0.0.0
0.0.0.0     0.0.0.0
```

The first entry enables connections from your own host, which is the NIS server. The second one allows all hosts with access to the same network to send requests to the server.

5. Click *Finish* to save changes and exit the setup.

3.2 Configuring NIS clients

To use NIS on a workstation, do the following:

1. Start *YaST* > *Network Services* > *NIS Client*.
2. Activate the *Use NIS* button.
3. Enter the NIS domain. This is a domain name given by your administrator or a static external IP address received by DHCP. For information about DHCP, see *Book "Administration Guide", Chapter 40 "DHCP"*.

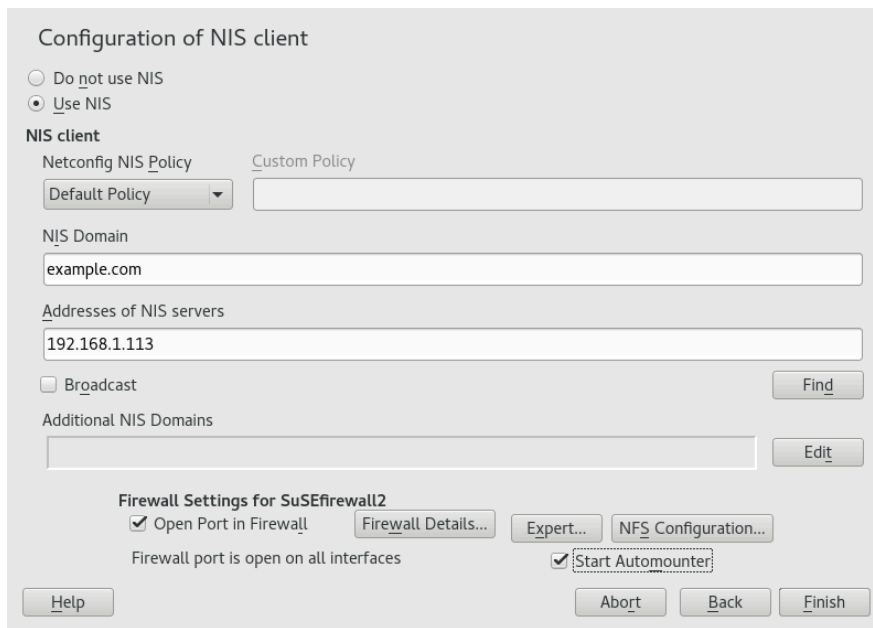

FIGURE 3.6: SETTING DOMAIN AND ADDRESS OF A NIS SERVER

4. Enter your NIS servers and separate their addresses by spaces. If you do not know your NIS server, click *Find* to let YaST search for any NIS servers in your domain. Depending on the size of your local network, this may be a time-consuming process. *Broadcast* asks for a NIS server in the local network after the specified servers fail to respond.
5. Depending on your local installation, you may also want to activate the automounter. This option also installs additional software if required.
6. If you do not want other hosts to be able to query which server your client is using, go to the *Expert* settings and disable *Answer Remote Hosts*. By checking *Broken Server*, the client is enabled to receive replies from a server communicating through an unprivileged port. For further information, see `man ypbind`.
7. Click *Finish* to save them and return to the YaST control center. Your client is now configured with NIS.

4 Setting up authentication clients using YaST

Whereas Kerberos is used for authentication, LDAP is used for authorization and identification. Both can work together. For more information about LDAP, see [Chapter 5, LDAP with 389 Directory Server](#), and about Kerberos, see [Chapter 6, Network authentication with Kerberos](#).

4.1 Configuring an authentication client with YaST

YaST allows setting up authentication to clients using different modules:

- **User logon management.** Use both an identity service (usually LDAP) and a user authentication service (usually Kerberos). This option is based on SSSD and in the majority of cases is best suited for joining Active Directory domains.

This module is described in [Section 7.3.2, “Joining Active Directory using User logon management”](#).

- **Windows domain membership.** Join an Active Directory (which entails use of Kerberos and LDAP). This option is based on `winbind` and is best suited for joining an Active Directory domain if support for NTLM or cross-forest trusts is necessary.

This module is described in [Section 7.3.3, “Joining Active Directory using Windows domain membership”](#).

4.2 SSSD

Two of the YaST modules are based on SSSD: *User Logon Management* and *LDAP and Kerberos Authentication*.

SSSD stands for System Security Services Daemon. SSSD talks to remote directory services that provide user data and provides authentication methods, such as LDAP, Kerberos, or Active Directory (AD). It also provides an NSS (Name Service Switch) and PAM (Pluggable Authentication Module) interface.

SSSD can locally cache user data and then allow users to use the data, even if the real directory service is (temporarily) unreachable.

4.2.1 Checking the status

After running one of the YaST authentication modules, you can check whether SSSD is running with:

```
# systemctl status sssd
sssd.service - System Security Services Daemon
  Loaded: loaded (/usr/lib/systemd/system/sssd.service; enabled)
  Active: active (running) since Thu 2015-10-23 11:03:43 CEST; 5s ago
  [...]
```

4.2.2 Caching

To allow logging in when the authentication back-end is unavailable, SSSD uses its cache even if it was invalidated. This happens until the back-end is available again.

To invalidate the cache, run `sss_cache -E` (the command `sss_cache` is part of the package `sssd-tools`).

To remove the SSSD cache, run:

```
> sudo systemctl stop sssd
> sudo rm -f /var/lib/sss/db/*
> sudo systemctl start sssd
```

5 LDAP with 389 Directory Server

The Lightweight Directory Access Protocol (LDAP) is a protocol designed to access and maintain information directories. LDAP can be used for tasks such as user and group management, system configuration management, and address management. In SUSE Linux Enterprise Server 15 SP6, the LDAP service is provided by the 389 Directory Server, replacing OpenLDAP.

Ideally, a central server stores the data in a directory and distributes it to all clients using a well-defined protocol. The structured data allow a wide range of applications to access them. A central repository reduces the necessary administrative effort. The use of an open and standardized protocol such as LDAP ensures that as many client applications as possible can access such information.

A directory in this context is a type of database optimized for quick and effective reading and searching. The type of data stored in a directory tends to be long lived and changes infrequently. This allows the LDAP service to be optimized for high performance concurrent reads, whereas conventional databases are optimized for accepting many writes to data in a short time.

5.1 Structure of an LDAP directory tree

This section introduces the layout of an LDAP directory tree, and provides the basic terminology used with regard to LDAP. If you are familiar with LDAP, read on at [Section 5.3.1, “Setting up a new 389 Directory Server instance”](#).

An LDAP directory has a tree structure. All entries (called objects) of the directory have a defined position within this hierarchy. This hierarchy is called the *directory information tree* (DIT). The complete path to the desired entry, which unambiguously identifies it, is called the *distinguished name* or DN. An object in the tree is identified by its *relative distinguished name* (RDN). The distinguished name is built from the RDNs of all entries on the path to the entry.

The relations within an LDAP directory tree become more evident in the following example, shown in [Figure 5.1, “Structure of an LDAP directory”](#).

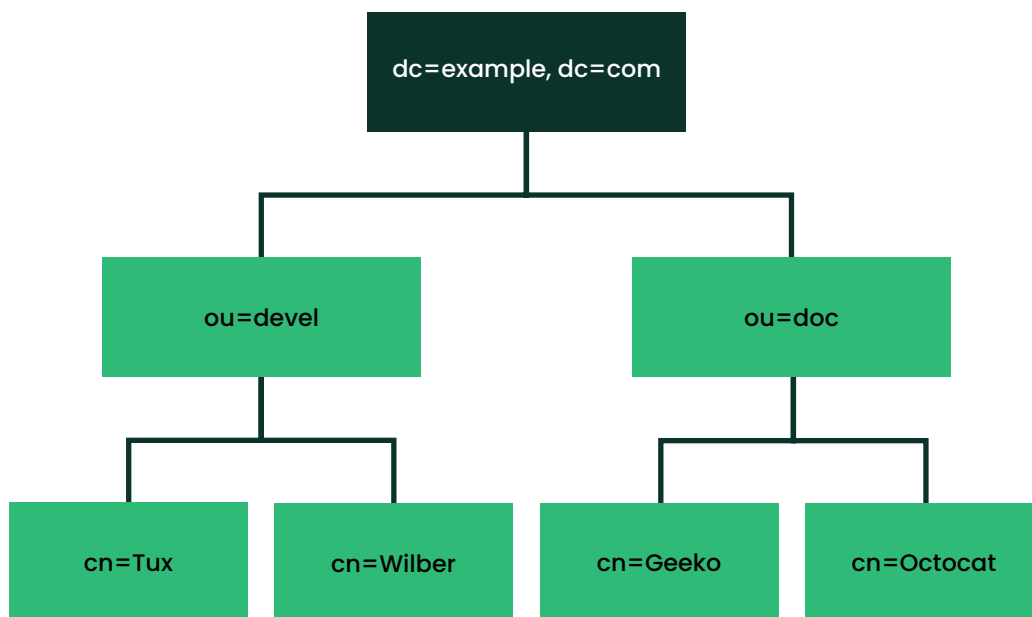

FIGURE 5.1: STRUCTURE OF AN LDAP DIRECTORY

The complete diagram is a fictional directory information tree. The entries on three levels are depicted. Each entry corresponds to one box in the image. The complete, valid *distinguished name* for the fictional employee `Geeko Linux`, in this case, is `cn=Geeko Linux,ou=doc,dc=example,dc=com`. It is composed by adding the RDN `cn=Geeko Linux` to the DN of the preceding entry `ou=doc,dc=example,dc=com`.

The types of objects that can be stored in the DIT are globally determined following a *Schema*. The type of an object is determined by the *object class*. The object class determines what attributes the relevant object must or may be assigned. The Schema contains all object classes and attributes which can be used by the LDAP server. Attributes are a structured data type. Their syntax, ordering and other behavior is defined by the Schema. LDAP servers supply a core set of Schemas which can work in a broad variety of environments. If a custom Schema is required, you can upload it to an LDAP server.

Table 5.1, "Commonly used object classes and attributes" offers a small overview of the object classes from `00core.ldif` and `06inetorgperson.ldif` used in the example, including required attributes (Req. Attr.) and valid attribute values. After installing 389 Directory Server, these can be found in `/usr/share/dirsrv/schema`.

TABLE 5.1: COMMONLY USED OBJECT CLASSES AND ATTRIBUTES

Object Class	Meaning	Example Entry	Req. Attr.
<u>domain</u>	name components of the domain	example	display-Name
<u>organizationalUnit</u>	organizational unit	<u>documenta- tiondept</u>	<u>ou</u>
<u>nsPerson</u>	person-related data for the intranet or Internet	<u>Tux Linux</u>	<u>cn</u>

Example 5.1, “Excerpt from CN=schema” shows an excerpt from a Schema directive with explanations.

EXAMPLE 5.1: EXCERPT FROM CN=SCHEMA

```

attributetype (1.2.840.113556.1.2.102 NAME 'memberOf' ❶
  DESC 'Group that the entry belongs to' ❷
  SYNTAX 1.3.6.1.4.1.1466.115.121.1.12 ❸
  X-ORIGIN 'Netscape Delegated Administrator') ❹

objectclass (2.16.840.1.113730.3.2.333 NAME 'nsPerson' ❺
  DESC 'A representation of a person in a directory server' ❻
  SUP top STRUCTURAL ❼
  MUST ( displayName $ cn ) ❽
  MAY ( userPassword $ seeAlso $ description $ legalName $ mail \
    $ preferredLanguage ) ❾
  X-ORIGIN '389 Directory Server Project'
  ...

```

- ❶ The name of the attribute, its unique *object identifier* (OID, numerical), and the abbreviation of the attribute.
- ❷ A brief description of the attribute with DESC. The corresponding RFC, on which the definition is based, may also be mentioned here.
- ❸ The type of data that can be held in the attribute. In this case, it is a case-insensitive directory string.
- ❹ The source of the schema element (for example, the name of the project).
- ❺ The definition of the object class nsPerson begins with an OID and the name of the object class (like the definition of the attribute).

- ⑥ A brief description of the object class.
- ⑦ The SUP top entry indicates that this object class is not subordinate to another object class.
- ⑧ With MUST, list all attribute types that must be used with an object of the type nsPerson.
- ⑨ With MAY, list all attribute types that are optionally permitted with this object class.

5.2 Creating and managing a Docker container for 389 Directory Server



Note

This section is *OPTIONAL*; refer to it if you use a 389 Directory Server instance as a Docker container. For regular usage of a 389 Directory Server instance, refer to the rest of the sections.

To create and manage a 389 Directory Server instance as a Docker container, refer to the following examples:

Pull the latest 389 Directory Server image

To pull the latest 389 Directory Server image from the container registry, run the following command:

```
> docker pull 389ds/dirsrv:latest
```

Create a new volume

To create a new volume for the container, run the following example command:

```
> docker volume create VOLUME
```

Create a container with basic configuration

To create a container with basic configuration, run the following example command:

```
> docker create \  
-u USERNAME \  
-e SUFFIX_NAME="dc=example,dc=com" \  
-e DS_DM_PASSWORD=PASSWORD \  
-m 1024M \  
-p 3389:3389 -p 3636:3636 \  
-v VOLUME:/data \  
--name INSTANCE \  
389ds/dirsrv:latest
```

Start the Docker container for 389 Directory Server

To start the Docker container, run the following example command:

```
> docker start INSTANCE
```

Execute a command within a running 389 Directory Server container

Assuming that the primary process of the container (PID 1) is running, you can run a command within a running 389 Directory Server container by using the following syntax:

```
> sudo docker exec -u USERNAME -i -t INSTANCE COMMAND
```



Note: The *COMMAND* must be executable

To run a chained command or a command enclosed within quotations, you should first run a shell session in the container. For example, you can run commands in the sh shell attached to the container:

```
> sudo docker exec -u USERNAME -i -t INSTANCE sh -c "COMMAND"
```

Stop the Docker container for 389 Directory Server

To stop the running Docker container, run the following example command:

```
> docker stop INSTANCE
```

Remove the Docker container for 389 Directory Server

To remove the Docker container, run the following example command:

```
> docker rm INSTANCE
```

5.3 Installing 389 Directory Server

Install 389 Directory Server with the following command:

```
> sudo zypper install 389-ds
```

After installation, set up the server as described in [Section 5.3.1, “Setting up a new 389 Directory Server instance”](#).

5.3.1 Setting up a new 389 Directory Server instance

You will use the **dscreate** command to create new 389 Directory Server instances, and the **dsctl** command to cleanly remove them.

There are two ways to configure and create a new instance: from a custom configuration file, and from an auto-generated template file. You can use the auto-generated template without changes for a test instance, though for a production system you must carefully review it and make any necessary changes.

Then you will set up administration credentials, manage users and groups, and configure identity services.

The 389 Directory Server is controlled by three primary commands:

dsctl

Manages a local instance and requires root permissions. Requires you to be connected to a terminal which is running the directory server instance. Used for starting, stopping, backing up the database, and more.

dsconf

The primary tool used for administration and configuration of the server. Manages an instance's configuration via its external interfaces. This allows you to make configuration changes remotely on the instance.

dsidm

Used for identity management (managing users, groups, passwords, etc.). The permissions are granted by access controls, so, for example, users can reset their own password or change details of their own account.

Follow these steps to set up a simple instance for testing and development, populated with a small set of sample entries.

1. *Creating a 389 Directory Server instance with a custom configuration file*
2. *Creating a 389 Directory Server instance from a template*
3. *Configuring administrator credentials for local administration*
4. *Managing LDAP users and groups*
5. *Using SSSD to manage LDAP authentication*
6. *Managing plug-ins*
7. *Importing TLS server certificates and keys*

5.3.2 Creating a 389 Directory Server instance with a custom configuration file

You can create a new 389 Directory Server instance from a simple custom configuration file. This file must be in the INF format, and you can name it anything you like.

The default instance name is `localhost`. The instance name cannot be changed after it has been created. It is better to create your own instance name, rather than using the default, to avoid confusion and to enable a better understanding of how it all works. The following examples use the `LDAP1` instance name, and a suffix of `dc=LDAP1,dc=COM`.

Example 5.2 shows an example configuration file that you can use to create a new 389 Directory Server instance. You can copy and use this file without changes.

1. Copy the following example file, `LDAP1.inf`, to your home directory:

EXAMPLE 5.2: MINIMAL 389 DIRECTORY SERVER INSTANCE CONFIGURATION FILE

```
# LDAP1.inf

[general]
config_version = 2 ❶

[slapd]
root_password = PASSWORD ❷
self_sign_cert = True ❸
instance_name = LDAP1

[backend-userroot]
sample_entries = yes ❹
suffix = dc=LDAP1,dc=COM
```

- 1 This line is required, indicating that this is a version 2 setup INF file.
 - 2 Create a strong `root_password` for the ldap user `cn=Directory Manager`. This user is for connecting (binding) to the directory.
 - 3 Create self-signed server certificates in `/etc/dirsrv/slapd-LDAP1`.
 - 4 Populate the new instance with sample user and group entries.
2. To create the 389 Directory Server instance from *Example 5.2*, run the following command:

```
> sudo dscreate -v from-file LDAP1.inf | \
tee LDAP1-OUTPUT.txt
```

This shows all activity during the instance creation, stores all the messages in `LDAP1-OUTPUT.txt`, and creates a working LDAP server in about a minute. The verbose output contains a lot of useful information. If you do not want to save it, then delete the `| tee LDAP1-OUTPUT.txt` portion of the command.

3. If the `dscreate` command should fail, the messages will tell you why. After correcting any issues, remove the instance (see *Step 5*) and create a new instance.
4. A successful installation reports `Completed installation for LDAP1`. Check the status of your new server:

```
> sudo dsctl LDAP1 status
Instance "LDAP1" is running
```

5. The following commands are for cleanly removing the instance. The first command performs a dry run and does not remove the instance. When you are sure you want to remove it, use the second command with the `--do-it` option:

```
> sudo dsctl LDAP1 remove
Not removing: if you are sure, add --do-it

> sudo dsctl LDAP1 remove --do-it
```

This command also removes partially installed or corrupted instances. You can reliably create and remove instances as often as you want.

If you forget the name of your instance, use `dsctl` to list all instances:

```
> sudo dsctl -l
slapd-LDAP1
```

5.3.3 Creating a 389 Directory Server instance from a template

You can auto-create a template for a new 389 Directory Server instance with the **dscreate** command. This creates a template that you can use without making any changes, for testing. For production systems, review and change it to suit your own requirements. The defaults are documented in the template file, and commented out. To make changes, uncomment the default and enter your own value. All options are well documented.

The following example prints the template to stdout:

```
> sudo dscreate create-template
```

This is good for a quick review of the template, but you must create a file to use in creating your new 389 Directory Server instance. You can name this file anything you want:

```
> sudo dscreate create-template TEMPLATE.txt
```

This is a snippet from the new file:

```
# full_machine_name (str)
# Description: Sets the fully qualified hostname (FQDN) of this system. When
# installing this instance with GSSAPI authentication behind a load balancer, set
# this parameter to the FQDN of the load balancer and, additionally, set
# "strict_host_checking" to "false".
# Default value: ldapserver1.test.net
;full_machine_name = ldapserver1.test.net

# selinux (bool)
# Description: Enables SELinux detection and integration during the installation
# of this instance. If set to "True", dscreate auto-detects whether SELinux is
# enabled. Set this parameter only to "False" in a development environment.
# Default value: True
;selinux = True
```

It automatically configures certain options from your existing environment; for example, the system's fully-qualified domain name, which is called `full_machine_name` in the template. Use this file with no changes to create a new instance:

```
> sudo dscreate from-file TEMPLATE.txt
```

This creates a new instance named `localhost`, and automatically starts it after creation:

```
> sudo dsctl localhost status
Instance "localhost" is running
```

The default values create a fully operational instance, but there are certain values you might want to change.

The instance name cannot be changed after it has been created. It is better to create your own instance name, rather than using the default, to avoid confusion and to enable a better understanding of how it all works. To do this, uncomment the `;instance_name = localhost` line and change `localhost` to your chosen name. In the following examples, the instance name is `LDAP1`.

Another useful change is to populate your new instance with sample users and groups. Uncomment `;sample_entries = no` and change `no` to `yes`. This creates the `demo_user` and `demo_group`.

Set your own password by uncommenting `;root_password`, and replacing the default password with your own.

The template does not create a default suffix, so you should configure your own on the `suffix` line, like the following example:

```
suffix = dc=LDAP1,dc=COM
```

You can cleanly remove any instance and start over with `dsctl`:

```
> sudo dsctl LDAP1 remove --do-it
```

5.3.4 Stopping and starting 389 Directory Server

The following examples use `LDAP1` as the instance name. Use `systemd` to manage your 389 Directory Server instance. Get the status of your instance:

```
> systemctl status --no-pager --full dirsrv@LDAP1.service
● dirsrv@LDAP1.service - 389 Directory Server LDAP1.
   Loaded: loaded (/usr/lib/systemd/system/dirsrv@.service; enabled; vendor preset: disabled)
   Active: active (running) since Thu 2021-03-11 08:55:28 PST; 2h 7min ago
   Process: 4451 ExecStartPre=/usr/lib/dirsrv/ds_systemd_ask_password_acl /etc/dirsrv/slapd-LDAP1/dse.ldif (code=exited, status=0/SUCCESS)
  Main PID: 4456 (ns-slapd)
   Status: "slapd started: Ready to process requests"
     Tasks: 26
   CGroup: /system.slice/system-dirsrv.slice/dirsrv@LDAP1.service
           └─4456 /usr/sbin/ns-slapd -D /etc/dirsrv/slapd-LDAP1 -i /run/dirsrv/slapd-LDAP1.pid
```

Start, stop and restart your LDAP server:

```
> sudo systemctl start dirsrv@LDAP1.service
> sudo systemctl stop dirsrv@LDAP1.service
> sudo systemctl restart dirsrv@LDAP1.service
```

See Book “Administration Guide”, Chapter 19 “The systemd daemon” for more information on using **systemctl**.

The **dsctl** command also starts and stops your server:

```
> sudo dsctl LDAP1 status
> sudo dsctl LDAP1 stop
> sudo dsctl LDAP1 restart
> sudo dsctl LDAP1 start
```

5.3.5 Configuring administrator credentials for local administration

For local administration of the 389 Directory Server, you can create a `.dsrc` configuration file in the `/root` directory, allowing root and sudo users to administer the server without typing connection details with every command. *Example 5.3* shows an example for local administration on the server, using `LDAP1` and `com` for the suffix.

After creating your `/root/.dsrc` file, try a few administration commands, such as creating new users (see *Section 5.6, “Managing LDAP users and groups”*).

EXAMPLE 5.3: A `.dsrc` FILE FOR LOCAL ADMINISTRATION

```
# /root/.dsrc file for administering the LDAP1 instance

[LDAP1] ❶

uri = ldapi://%%2fvar%%2frun%%2fslapd-LDAP1.socket ❷
basedn = dc=LDAP1,dc=COM
binddn = cn=Directory Manager
```

- ❶ This must specify your exact instance name.
- ❷ `ldapi` detects the UID and GID of the user attempting to log in to the server. If the UID/GID are `0/0` or `dirsrv:dirsrv`, `ldapi` binds the user as the directory server root dn, which is `cn=Directory Manager`.

In the URI, the slashes are replaced with `%%2f`, so in this example the path is `/var/run/slapd-LDAP1.socket`.



Important: New negation feature in sudoers.ldap

In `sudo` versions older than 1.9.9, negation in `sudoers.ldap` does not work for the `sudoUser`, `sudoRunAsUser`, or `sudoRunAsGroup` attributes. For example:

```
# does not match all but joe
# instead, it does not match anyone
sudoUser: !joe

# does not match all but joe
# instead, it matches everyone including Joe
sudoUser: ALL
sudoUser: !joe
```

In `sudo` version 1.9.9 and higher, negation is enabled for the `sudoUser` attribute. See [man 5 sudoers.ldap](#) for more information.

5.4 Firewall configuration

The default TCP ports for 389 Directory Server are 389 and 636. TCP 389 is for unencrypted connections, and STARTTLS. 636 is for encrypted connections over TLS.

`firewalld` is the default firewall manager for SUSE Linux Enterprise Server. The following rules activate the `ldap` and `ldaps` firewall services:

```
> sudo firewall-cmd --add-service=ldap --zone=internal
> sudo firewall-cmd --add-service=ldaps --zone=internal
> sudo firewall-cmd --runtime-to-permanent
```

Replace the zone with the appropriate zone for your server. See [Section 5.10, “Importing TLS server certificates and keys”](#) for information on securing your connections with TLS, and [Section 23.3, “Firewalling basics”](#) to learn about `firewalld`.

5.5 Backing up and restoring 389 Directory Server

389 Directory Server supports making offline and online backups. The `dsctl` command makes offline database backups, and the `dsconf` command makes online database backups. Back up the LDAP server configuration directory to enable complete restoration in case of a major failure.

5.5.1 Backing up the LDAP server configuration

Your LDAP server configuration is in the directory `/etc/dirsrv/slapd-INSTANCE_NAME`. This directory contains certificates, keys and the `dse.ldif` file. Make a compressed backup of this directory with the `tar` command:

```
> sudo tar caf \
config_slapd-INSTANCE_NAME-${date +%Y-%m-%d_%H-%M-%S}.tar.gz \
/etc/dirsrv/slapd-INSTANCE_NAME/
```



Note: Harmless tar error message

When running `tar`, you may see the harmless informational message `tar: Removing leading `/' from member names.`

To restore a previous configuration, unpack it to the same directory:

1. (Optional) To avoid overwriting an existing configuration, move it:

```
> sudo mv /etc/dirsrv/slapd-INSTANCE_NAME/
```

2. Unpack the backup archive:

```
> sudo tar -xvzf \
config_slapd-INSTANCE_NAME-DATE.tar.gz
```

3. Copy it to `/etc/dirsrv/slapd-INSTANCE_NAME`:

```
> sudo cp -r etc/dirsrv/slapd-INSTANCE_NAME \
/etc/dirsrv/slapd-INSTANCE_NAME
```

5.5.2 Creating an offline backup of the LDAP database and restoring from it

The `dsctl` command makes offline backups. Stop the server:

```
> sudo dsctl INSTANCE_NAME stop
Instance "INSTANCE_NAME" has been stopped
```

Then make the backup using your instance name. The following example creates a backup archive at `/var/lib/dirsrv/slapd-INSTANCE_NAME/bak/INSTANCE_NAME-DATE`:

```
> sudo dsctl INSTANCE_NAME db2bak
```

```
db2bak successful
```

For example, on a test instance named `ldap1` it looks like this:

```
/var/lib/dirsrv/slapd-ldap1/bak/ldap1-2021_10_25_13_03_17
```

Restore from this backup, naming the directory containing the backup archive:

```
> sudo dsctl INSTANCE_NAME bak2db \  
/var/lib/dirsrv/slapd-INSTANCE_NAME/bak/INSTANCE_NAME-DATE/  
bak2db successful
```

Then start the server:

```
> sudo dsctl INSTANCE_NAME start  
Instance "INSTANCE_NAME" has been started
```

You can also create LDIF backups:

```
> sudo dsctl INSTANCE_NAME db2ldif --replication userRoot  
ldiffile: /var/lib/dirsrv/slapd-INSTANCE_NAME/ldif/INSTANCE_NAME-userRoot-DATE.ldif  
db2ldif successful
```

Restore an LDIF backup with the name of the archive, then start the server:

```
> sudo dsctl ldif2db userRoot \  
/var/lib/dirsrv/slapd-INSTANCE_NAME/ldif/INSTANCE_NAME-userRoot-DATE.ldif  
> sudo dsctl INSTANCE_NAME start
```

5.5.3 Creating an online backup of the LDAP database and restoring from it

Use the `dsconf` to make an online backup of your LDAP database:

```
> sudo dsconf INSTANCE_NAME backup create  
The backup create task has finished successfully
```

This creates `/var/lib/dirsrv/slapd-INSTANCE_NAME/bak/INSTANCE_NAME-DATE.`

Restore it:

```
> sudo dsconf INSTANCE_NAME backup restore \  
/var/lib/dirsrv/slapd-INSTANCE_NAME/bak/INSTANCE_NAME-DATE
```

5.6 Managing LDAP users and groups

Use the `dsidm` command to create, remove and manage users and groups.

5.6.1 Querying existing LDAP users and groups

The following examples show how to list your existing users and groups. The examples use the instance name `LDAP1`. Replace this with your instance name:

```
> sudo dsidm LDAP1 user list
> sudo dsidm LDAP1 group list
```

List all information on a single user:

```
> sudo dsidm LDAP1 user get USER
```

List all information on a single group:

```
> sudo dsidm LDAP1 group get GROUP
```

List members of a group:

```
> sudo dsidm LDAP1 group members GROUP
```

5.6.2 Creating users and managing passwords

In the following example, we create one user, `wilber`. The example server instance is named `LDAP1`, and the instance's suffix is `dc=LDAP1,dc=COM`.

PROCEDURE 5.1: CREATING LDAP USERS

The following example creates the user Wilber Fox on your 389 DS instance:

```
1. > sudo dsidm LDAP1 user create --uid wilber \
   --cn wilber --displayName 'Wilber Fox' --uidNumber 1001 --gidNumber 101 \
   --homeDirectory /home/wilber
```

2. Verify by looking up your new user's distinguished name (fully qualified name to the directory object, which is guaranteed unique):

```
> sudo dsidm LDAP1 user get wilber
dn: uid=wilber,ou=people,dc=LDAP1,dc=COM
[...]
```

You need the distinguished name for actions such as changing the password for a user.

3. Create a password for new user wilber:

```
a. > sudo dsidm LDAP1 account reset_password \  
uid=wilber,ou=people,dc=LDAP1,dc=COM
```

b. Enter the new password for wilber twice.

If the action was successful, you get the following message:

```
reset password for uid=wilber,ou=people,dc=LDAP1,dc=COM
```

Use the same command to change an existing password.

4. Verify that the user's password works:

```
> ldapwhoami -D uid=wilber,ou=people,dc=LDAP1,dc=COM -W  
Enter LDAP Password: PASSWORD  
dn: uid=wilber,ou=people,dc=LDAP1,dc=COM
```

5.6.3 Creating and managing groups

After creating users, you can create groups, and then assign users to them. In the following examples, we create a group, server_admins, and assign the user wilber to this group. The example server instance is named LDAP1, and the instance's suffix is dc=LDAP1,dc=COM.

PROCEDURE 5.2: CREATING LDAP GROUPS AND ASSIGNING USERS TO THEM

1. Create the group:

```
> sudo dsidm LDAP1 group create
```

You will be prompted for a group name. Enter your chosen group name, which in the following example is SERVER_ADMINS:

```
Enter value for cn : SERVER_ADMINS
```

2. Add the user wilber (created in *Procedure 5.1, "Creating LDAP users"*) to the group:

```
> sudo dsidm LDAP1 group add_member SERVER_ADMINS \  
uid=wilber,ou=people,dc=LDAP1,dc=COM  
added member: uid=wilber,ou=people,dc=LDAP1,dc=COM
```

5.6.4 Deleting users and groups, and removing users from groups

Use the `dsidm` command to delete users, remove users from groups, and delete groups. The following example removes our example user `wilber` from the `server_admins` group:

```
> sudo dsidm LDAP1 group remove_member SERVER_ADMINS \  
uid=wilber,ou=people,dc=LDAP1,dc=COM
```

Delete a user:

```
> sudo dsidm LDAP1 user delete \  
uid=wilber,ou=people,dc=LDAP1,dc=COM
```

Delete a group:

```
> sudo dsidm LDAP1 group delete SERVER_ADMINS
```

5.7 Managing plug-ins

Use the following command to list all available plug-ins, enabled and disabled. Use your server's hostname rather than the instance name of your 389 Directory Server, like the following example hostname of `LDAPSERVER1`:

```
> sudo dsconf -D "cn=Directory Manager" ldap://LDAPSERVER1 plugin list  
Enter password for cn=Directory Manager on ldap://LDAPSERVER1: PASSWORD  
  
7-bit check  
Account Policy Plugin  
Account Usability Plugin  
ACL Plugin  
ACL preoperation  
[...]
```

The following command enables the `MemberOf` plug-in referenced in [Section 5.8, "Using SSSD to manage LDAP authentication"](#). `MemberOf` simplifies user searches, by returning the user and any groups the user belongs to, with a single command. Without `MemberOf`, a client must run multiple lookups to find a user's group memberships.

```
> sudo dsconf -D "cn=Directory Manager" ldap://LDAPSERVER1 plugin memberof enable
```

The plug-in names used in commands are lowercase, so they are different from how they appear when you list them. If you make a mistake with a plug-in name, you see a helpful error message:

```
dsconf instance plugin: error: invalid choice: 'MemberOf' (choose from
```

```
'memberof', 'automember', 'referential-integrity', 'root-dn', 'usn',  
'account-policy', 'attr-uniq', 'dna', 'linked-attr', 'managed-entries',  
'pass-through-auth', 'retro-changelog', 'posix-winsync', 'contentsync', 'list',  
'show', 'set')
```

After enabling a plug-in, it is necessary to restart the server:

```
> sudo systemctl restart dirsrv@LDAPSERVER1.service
```

Next, configure the plug-in. The following example enables `MemberOf` to search all entries. Use your instance name rather than the server's hostname:

```
> sudo dsconf LDAP1 plugin memberOf set --scope dc=example,dc=com  
Successfully changed the cn=MemberOf Plugin,cn=plugins,cn=config
```

After the `MemberOf` plug-in is enabled and configured, all new groups and users are automatically `MemberOf` targets. However, any users and groups that exist before it is enabled are not. They must be marked manually:

```
> sudo dsidm LDAP1 user modify suzanne add:objectclass:nsmemberof  
Successfully modified uid=suzanne,ou=people,dc=ldap1,dc=com
```

Now suzanne information and group membership are listed with a single command:

```
> sudo dsidm LDAP1 user get suzanne  
dn: uid=suzanne,ou=people,dc=ldap1,dc=com  
cn: suzanne  
displayName: Suzanne Geeko  
gidNumber: 102  
homeDirectory: /home/suzanne  
memberOf: cn=SERVER_ADMINS,ou=groups,dc=ldap1,dc=com
```

Modifying a larger number of users is a lot of work. The following example shows how to make all legacy users `MemberOf` targets with one `fixup` command:

```
> sudo dsconf LDAP1 plugin memberof fixup -f '(objectClass=*)' dc=LDAP1,dc=COM
```

5.7.1 Unsupported plug-ins on 389 Directory Server

The following plug-ins are not supported on 389 Directory Server:

- Distributed Numeric Assignment (DNA) plug-in
- Managed Entries Plug-in (MEP)
- Posix Winsync plug-in

5.8 Using SSSD to manage LDAP authentication

The System Security Services Daemon (SSSD) manages authentication, identification, and access controls for remote users. This section describes how to use SSSD to manage authentication and identification for your 389 Directory Server.

SSSD mediates between your LDAP server and clients. It supports several provider back-ends, such as LDAP, Active Directory, and Kerberos. SSSD supports services, including SSH, PAM, NSS and sudo. SSSD provides performance benefits and resilience through caching user IDs and credentials. Caching reduces the number of requests to your 389 DS server, and provides authentication and identity services when the back-ends are unavailable.

If the Name Services Caching Daemon (nscd) is running on your network, you should disable or remove it. nscd caches only the common name service requests, such as passwd, group, hosts, service and netgroup, and will conflict with SSSD.

Your LDAP server is the provider, and your SSSD instance is the client of the provider. You may install SSSD on your 389 DS server, but installing it on a separate machine provides some resilience in case the 389 DS server becomes unavailable. Use the following procedure to install and configure an SSSD client. The example 389 DS instance name is LDAP1:

1. Install the sssd and sssd-ldap packages:

```
> sudo zypper in sssd sssd-ldap
```

2. Back up the /etc/sssds/sssds.conf file, if it exists:

```
> sudo old /etc/sssds/sssds.conf
```

3. Create your new SSSD configuration template. The allowed output file names are sssds.conf and ldap.conf. display sends the output to stdout. The following example creates a client configuration in /etc/sssds/sssds.conf:

```
> sudo cd /etc/sssds
> sudo dsidm LDAP1 client_config sssds.conf
```

4. Review the output and make any necessary changes to suit your environment. The following /etc/sssds/sssds.conf file demonstrates a working example.



Important: MemberOf

The LDAP access filter relies on `MemberOf` being configured. For details, see [Section 5.7, “Managing plug-ins”](#).

```
[sssd]
services = nss, pam, ssh, sudo
config_file_version = 2
domains = default

[nss]
homedir_substring = /home

[domain/default]
# If you have large groups (for example, 50+ members),
# you should set this to True
ignore_group_members = False
debug_level=3
cache_credentials = True
id_provider = ldap
auth_provider = ldap
access_provider = ldap
chpass_provider = ldap

ldap_schema = rfc2307bis
ldap_search_base = dc=example,dc=com
# We strongly recommend ldaps
ldap_uri = ldaps://ldap.example.com
ldap_tls_reqcert = demand
ldap_tls_cacert = /etc/openldap/ldap.crt
ldap_access_filter = (|(memberof=cn=<login group>,ou=Groups,dc=example,dc=com))
enumerate = false
access_provider = ldap

ldap_user_member_of = memberof
ldap_user_gecos = cn
ldap_user_uuid = nsUniqueId
ldap_group_uuid = nsUniqueId
ldap_account_expire_policy = rhds
ldap_access_order = filter, expire
# add these lines to /etc/ssh/sshd_config
# AuthorizedKeysCommand /usr/bin/sss_ssh_authorizedkeys
# AuthorizedKeysCommandUser nobody
ldap_user_ssh_public_key = nsSshPublicKey
```

5. Set file ownership to root, and restrict read-write permissions to root:

```
> sudo chown root:root /etc/sss/sss.conf
> sudo chmod 600 /etc/sss/sss.conf
```

6. Edit the `/etc/nsswitch.conf` configuration file on the SSSD server to include the following lines:

```
passwd: compat sss
group:  compat sss
shadow: compat sss
```

7. Edit the PAM configuration on the SSSD server, modifying `common-account-pc`, `common-auth-pc`, `common-password-pc`, and `common-session-pc`. SUSE Linux Enterprise Server provides a command to modify all of these files at once, **`pam-config`**:

```
> sudo pam-config -a --sss
```

8. Verify the modified configuration:

```
> sudo pam-config -q --sss
auth:
account:
password:
session:
```

9. Copy `/etc/dirsrv/slapd-LDAP1/ca.crt` from the 389 DS server to `/etc/openldap/certs` on your SSSD server, then rehash it:

```
> sudo c_rehash /etc/openldap/certs
```

10. Enable and start SSSD:

```
> sudo systemctl enable --now sssd
```

See [Chapter 4, Setting up authentication clients using YaST](#) for information on managing the `sss.service` with `systemctl`.

5.8.1 Unsupported password hashes and authentication schemes

The following are not supported as configuration values in `dse.ldif` for the settings `nss-lapd-rootpwstagescheme` or `passwordStorageScheme`, or as a value of `passwordStorageScheme` in the account policy objects:

- SHA
- SSHA
- SHA256
- SSHA256
- SHA384
- SSHA384
- SHA512
- SSHA512
- NS-MTA-MD5
- clear
- MD5
- SMD5



Note

Database imports that contain these values are supported if `nsslapd-enable-upgrade-hash` is set to `on` (defaults to `on`).

5.9 Migrating to 389 Directory Server from OpenLDAP

OpenLDAP is deprecated and no longer supported as of SUSE Linux Enterprise 15 SP3. It has been replaced by 389 Directory Server. SUSE provides the `openldap_to_ds` utility to assist with migration, included in the `389-ds` package.

The `openldap_to_ds` utility automates as much of the migration as possible. However, every LDAP deployment is different, and it is impossible to develop a tool that satisfies all situations. When necessary, intervene and perform manual steps. Additionally, test your migration procedure thoroughly before attempting a production migration.

Important: Read the **help** page

Before using the `openldap_to_ds` migration tool, we strongly recommend reading the output of `openldap_to_ds --help`. It helps you learn about the capabilities and limitations of the migration tool, and prevents you from making wrong assumptions.

5.9.1 Testing migration from OpenLDAP

Due to significant differences between OpenLDAP and 389 Directory Server, migration involves repeated testing and adjustments. It is helpful to do a quick migration test to get an idea of what steps are necessary for a successful migration.

Prerequisites:

- A running 389 Directory Server instance
- An OpenLDAP `slapd` configuration file or directory in dynamic ldif format
- An ldif file backup of your OpenLDAP database

If your `slapd` configuration is not in dynamic ldif format, create a dynamic copy with `slaptest`. Create a `slapd.d` directory, for example `/root/slapd.d/`, then run the following command:

```
> sudo slaptest -f /etc/openldap/slapd.conf -F /root/slapd.d
```

This results in several files similar to the following example:

```
> sudo ls /root/slapd.d/*

/root/slapd.d/cn=config.ldif

/root/slapd.d/cn=config:
cn=module{0}.ldif  cn=schema.ldif          olcDatabase={0}config.ldif
cn=schema          olcDatabase={-1}frontend.ldif olcDatabase={1}mdb.ldif
```

Create one ldif file per suffix. In the following examples, the suffix is `dc=LDAP1,dc=COM`. If you are using the `/etc/openldap/slapd.conf` format, use the following command to create the ldif backup file:

```
> sudo slapcat -f /etc/openldap/slapd.conf -b dc=LDAP1,dc=COM \
-l /root/LDAP1-COM.ldif
```

Use `openldap_to_ds` to analyze the configuration and files, and show a migration plan without changing anything:

```
> sudo openldap_to_ds LDAP1\
/root/slapd.d /root/LDAP1-COM.ldif.ldif
```

This performs a dry run and does not change anything. The output looks like this:

```
Examining OpenLDAP Configuration ...
Completed OpenLDAP Configuration Parsing.
Examining Ldifs ...
Completed Ldif Metadata Parsing.
The following migration steps will be performed:
* Schema Skip Unsupported Attribute -> otherMailbox (0.9.2342.19200300.100.1.22)
* Schema Skip Unsupported Attribute -> dSAQuality (0.9.2342.19200300.100.1.49)
* Schema Skip Unsupported Attribute -> singleLevelQuality (0.9.2342.19200300.100.1.50)
* Schema Skip Unsupported Attribute -> subtreeMinimumQuality
(0.9.2342.19200300.100.1.51)
* Schema Skip Unsupported Attribute -> subtreeMaximumQuality
(0.9.2342.19200300.100.1.52)
* Schema Create Attribute -> suseDefaultBase (SUSE.YaST.ModuleConfig.Attr:2)
* Schema Create Attribute -> suseNextUniqueId (SUSE.YaST.ModuleConfig.Attr:3)
[...]
* Schema Create ObjectClass -> suseDhcpConfiguration (SUSE.YaST.ModuleConfig.OC:10)
* Schema Create ObjectClass -> suseMailConfiguration (SUSE.YaST.ModuleConfig.OC:11)
* Database Reindex -> dc=example,dc=com
* Database Import Ldif -> dc=example,dc=com from example.ldif -
excluding entry attributes = [{'structuralobjectclass', 'entrycsn'}]
No actions taken. To apply migration plan, use '--confirm'
```

The following example performs the migration, and the output looks different from the dry run:

```
> sudo openldap_to_ds LDAP1 /root/slapd.d /root/LDAP1-COM.ldif --confirm
Starting Migration ... This may take some time ...
migration: 1 / 40 complete ...
migration: 2 / 40 complete ...
migration: 3 / 40 complete ...
[...]
Index task index_all_05252021_120216 completed successfully
post: 39 / 40 complete ...
post: 40 / 40 complete ...
# Migration complete!
-----
You should now review your instance configuration and data:
* [ ] - Create/Migrate Database Access Controls (ACI)
* [ ] - Enable and Verify TLS (LDAPS) Operation
* [ ] - Schedule Automatic Backups
* [ ] - Verify Accounts Can Bind Correctly
* [ ] - Review Schema Inconsistent ObjectClass -> pilotOrganization
(0.9.2342.19200300.100.4.20)
* [ ] - Review Database Imported Content is Correct -> dc=ldap1,dc=com
```

When the migration is complete, `openldap_to_ds` creates a checklist of post-migration tasks that must be completed. It is a best practice to document your post-migration steps, so that you can reproduce them in your post-production procedures. Then test clients and application integrations to the migrated 389 Directory Server instance.

Important: Develop a rollback plan

Develop a rollback plan in case of any failures. This plan should define a successful migration, the tests to determine what worked and what needs to be fixed, which steps are critical, what can be deferred until later, how to decide when to undo any changes, how to undo them with minimal disruption, and which other teams need to be involved.

Due to the variability of deployments, it is difficult to provide a recipe for a successful production migration. After you have thoroughly tested the migration process and verified that you get good results, the following general steps help:

- Lower all hostname/DNS TTLs to 5 minutes 48 hours before the change, to allow a fast rollback to your existing OpenLDAP deployment.
- Pause all data synchronization and incoming data processes, so that the data in the OpenLDAP environment does not change during the migration.

- Have all 389 Directory Server hosts ready for deployment before the migration.
- Have your test migration documentation available.

5.9.2 Testing migration of OpenLDAP servers that use `saslauthd`

In OpenLDAP deployments, it is common to use `saslauthd` for passthrough authentication of users. The authentication process involves the following components:

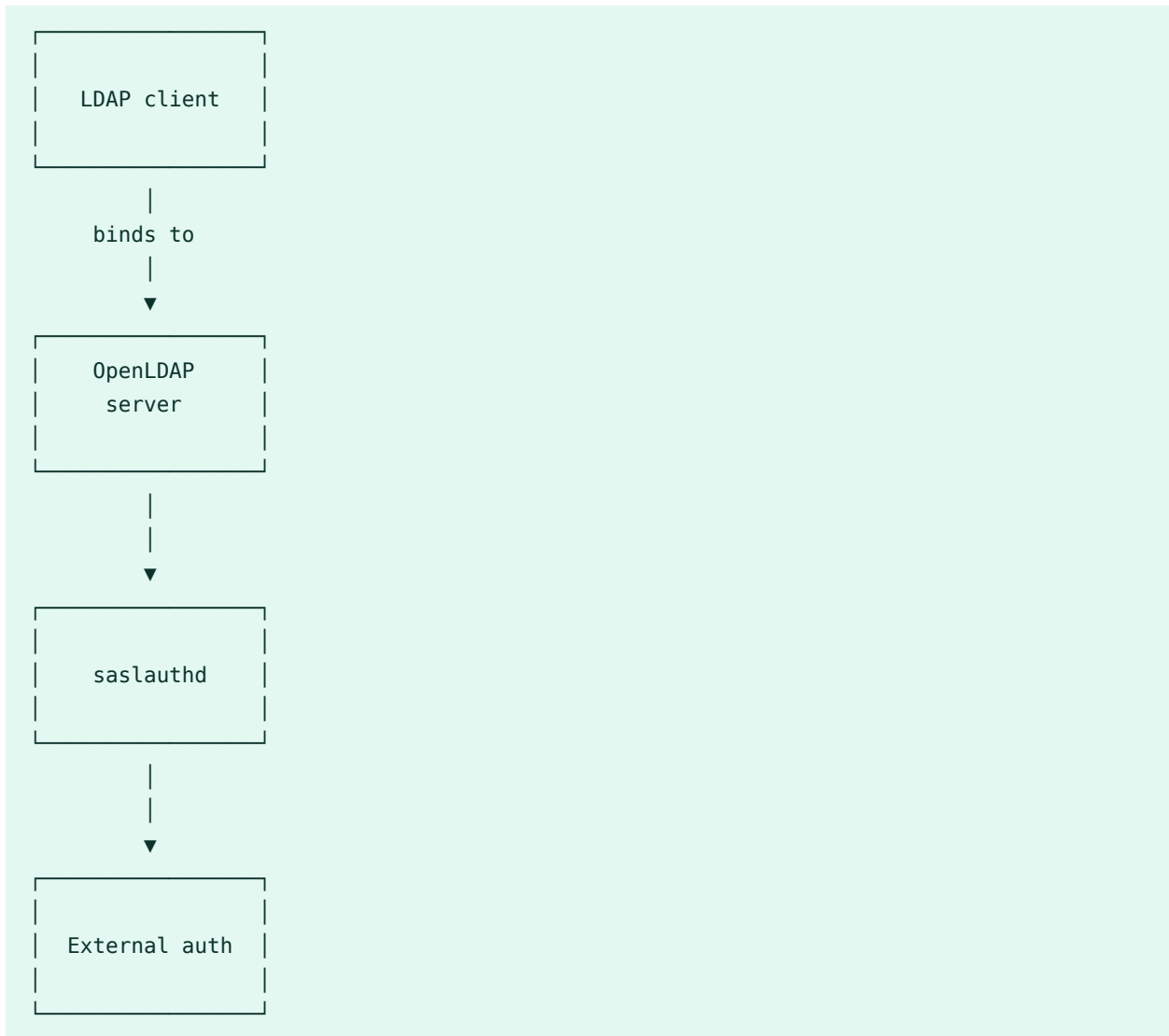

For checking the correctness of configuration and subsequent troubleshooting, the following information is important:

- OpenLDAP discovers that a user is allowed passthrough authentication if the `userPassword` attribute has a value with the `userPassword: {SASL}USERNAME@REALM` format. The prerequisite is to build the OpenLDAP server with the `--enable-spaswd` option to enable passthrough authentication.
- OpenLDAP configures its connection to `saslauthd` from `/usr/lib/sasl2/slapd.conf`.
- `saslauthd` discovers the relevant modules using its command-line parameters configured in `/etc/sysconfig/saslauthd`.
- The back-end modules of `saslauthd` use their own configuration, as documented in `man saslauthd`.

Detailed information about passthrough authentication using OpenLDAP is available in the official [OpenLDAP Admin Guide \(https://openldap.org/doc/admin24/security.html#Pass-Through%20authentication\)](https://openldap.org/doc/admin24/security.html#Pass-Through%20authentication).

5.9.2.1 Migrating SASL passthrough authentication from OpenLDAP to 389 Directory Server

As a best practice for correctly migrating SASL passthrough authentication from OpenLDAP to 389 Directory Server, refer to the following steps:

1. Before migration, ensure that you can successfully run `testsaslauthd` on the OpenLDAP server.

```
> sudo testsaslauthd -u USERNAME@REALM -p PASSWORD
```

The realm routes the authentication to the correct back-end in `saslauthd`, and the user name is then used to check the identity.

2. Install the `pam_saslauthd` package that enables 389 Directory Server to connect with `saslauthd`.

```
> sudo zypper install -y pam_saslauthd
```

3. Migrate from OpenLDAP to 389 Directory Server by running the `openldap_to_ds` command-line tool. For detailed information on the migration process, refer to the section [Section 5.9.1, "Testing migration from OpenLDAP"](#).



Note

While the `openldap_to_ds` process is running, if a user is detected as having the value of the `userPssword` attribute in the `userPassword: {SASL}USERNAME@REALM` format, it is removed and placed as the value of the `nsSaslauthId` attribute in the `nsSaslauthId: USERNAME@REALM` format. Additionally, the attribute value `objectClass: nsSaslauthAccount` is automatically added to support the modification.

4. After completion of the migration, check whether the PAM passthrough authentication is configured correctly by running the following commands:

```
> sudo dsconf INSTANCE plugin pam-pass-through-auth show
```

```
> sudo dsconf INSTANCE plugin pam-pass-through-auth list
```

After successful migration, the passthrough authentication flow involves the following components:

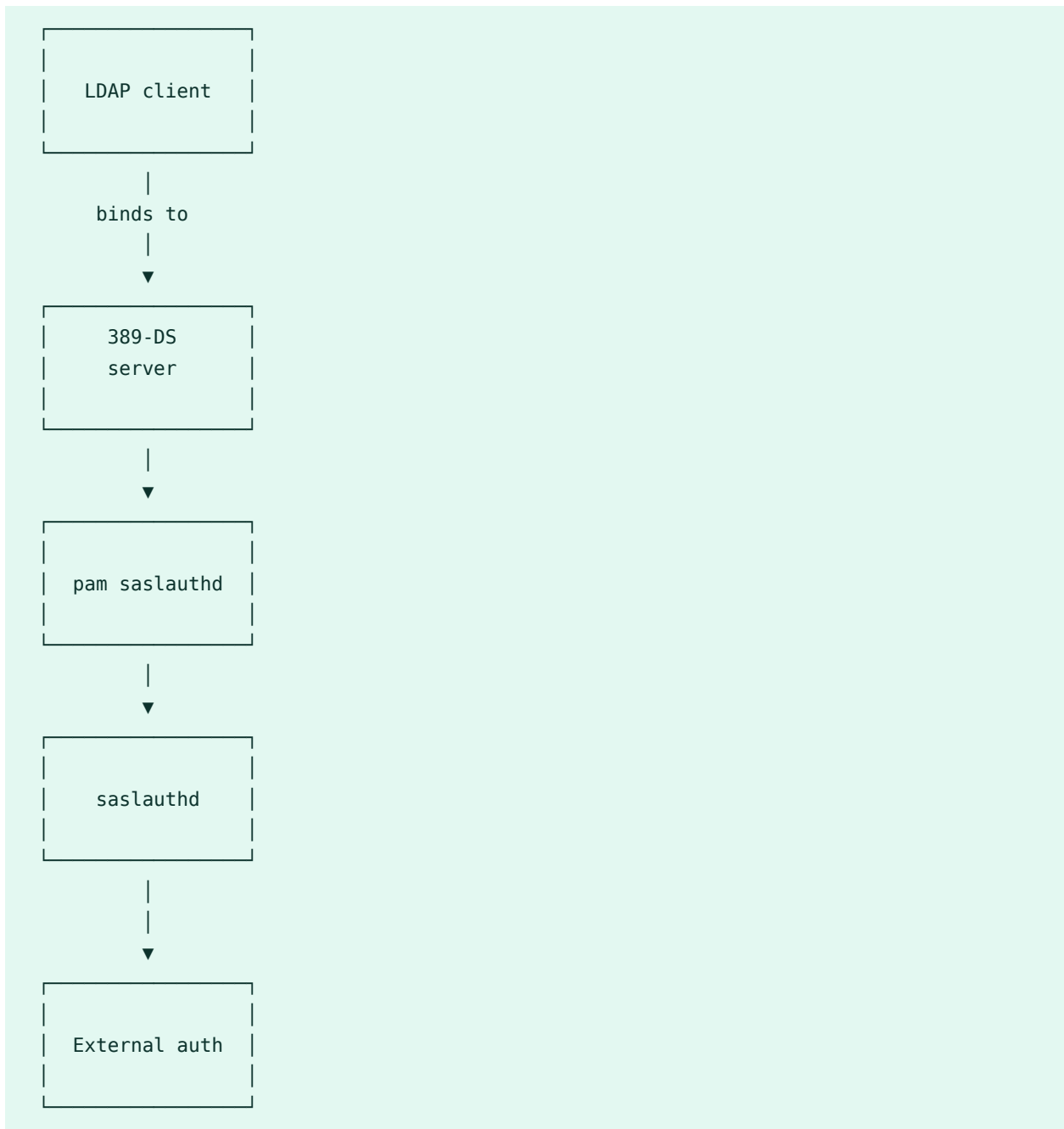

5.9.2.2 Troubleshooting `saslauthd` passthrough authentication

To troubleshoot problems with `saslauthd` passthrough authentication before and after the migration from OpenLDAP to 389 Directory Server, refer to the following tips:

Ensure that `testsaslauthd` works with `USERNAME@REALM`.

Refer to the step for running `testsaslauthd` in the *Section 5.9.2, "Testing migration of OpenLDAP servers that use `saslauthd`"* section.

In case of problems, try the following:

- Check `/etc/sysconfig/saslauthd` to ensure the `saslauthd` back-end modules are configured correctly. For detailed information on the back-end modules of `saslauthd` and their configurations, run `man saslauthd`.
- Turn on debug logging by adding `SASLAUTHD_PARAMS="-d"` in `/etc/sysconfig/saslauthd`.
- View the `saslauthd` logs that are available as part of the output of `journalctl`.

Ensure that PAM `saslauthd` works correctly.

To check if PAM `saslauthd` works correctly, you can use the `pam_tester` tool available at https://github.com/kanidm/pam_tester.



Note

The `pam_tester` tool is NOT officially supported.

Ensure that the PAM Pass Through Auth plug-in is enabled.

Check the status of the PAM Pass Through Auth plug-in by running the following command:

```
> sudo dsconf INSTANCE plugin pam-pass-through-auth status
```

To enable the plug-in, run the following command:

```
> sudo dsconf INSTANCE plugin pam-pass-through-auth enable
```

Check the configuration of the PAM Pass Through Auth plug-in.

To check the configuration of the PAM Pass Through Auth plug-in for the server instance, run the following command:

```
> sudo dsconf INSTANCE plugin pam-pass-through-auth show
```

Check the error logs for the user of the server instance.

Check the logs available in `/var/lib/SERVER_USER_NAME/INSTANCE/error`.

5.9.3 Planning your migration

As OpenLDAP is a “box of parts” and highly customizable, it is not possible to prescribe a “one size fits all” migration. It is necessary to assess your current environment and configuration with OpenLDAP and other integrations. This includes, and is not limited to:

- Replication topology
- High availability and load balancer configurations
- External data flows (IGA, HR, AD, etc.)
- Configured overlays (plug-ins in 389 Directory Server)
- Client configuration and expected server features
- Customized schema
- TLS configuration

Plan what your 389 Directory Server deployment will look like in the end. This includes the same list, except replace overlays with plug-ins. Once you have assessed your current environment and planned what your 389 Directory Server environment will look like, you can then form a migration plan. We recommended building the 389 Directory Server environment in parallel to your OpenLDAP environment to allow switching between them.

Migrating from OpenLDAP to 389 Directory Server is a one-way migration. There are enough differences between the two that they cannot interoperate, and there is not a migration path from 389 Directory Server to OpenLDAP. The following table highlights the major similarities and differences.

Feature	OpenLDAP	389 Directory Server	Compatible
Two-way replication	SyncREPL	389 DS-specific system	No
MemberOf	Overlay	Plug-in	Yes, simple configurations only
External Auth	Proxy	-	No
Active Directory Synchronization	-	Winsync Plug-in	No

Feature	OpenLDAP	389 Directory Server	Compatible
Inbuilt Schema	OLDAP Schemas	389 Schemas	Yes, supported by migration tool
Custom Schema	OLDAP Schemas	389 Schemas	Yes, supported by migration tool
Database Import	LDIF	LDIF	Yes, supported by migration tool
Password hashes	Varies	Varies	Yes, all formats supported excluding Argon2
OpenLDAP to 389 DS replication	-	-	No mechanism to replicate to 389 DS is possible
Time-based one-time password (TOTP)	TOTP overlay	-	No, currently not supported
entryUUID	Part of OpenLDAP	Plug-in	Yes

5.10 Importing TLS server certificates and keys

You can manage your CA certificates and keys for 389 Directory Server with the following command line tools: **certutil**, **openssl**, and **pk12util**.

For testing purposes, you can use the self-signed certificate that **dscreate** creates when you create a new 389 DS instance. Find the certificate at /etc/dirsrv/slapd-*INSTANCE-NAME*/ca.crt.

For production environments, it is a best practice to use a third-party certificate authority, such as Let's Encrypt, CAcert.org, SSL.com, or whatever CA you choose. Request a server certificate, a client certificate, and a root certificate.



Important

The Mozilla NSS (Network Security Services) toolkit uses nicknames for certificates in the certificate store. The server certificate uses the nickname *Server-Cert*.

1. Use the following commands to remove the Self-Signed-CA and Server-Cert from the instance:

```
> sudo dsctl INSTANCE_NAME tls remove-cert Self-Signed-CA
> sudo dsctl INSTANCE_NAME tls remove-cert Server-Cert
```

Replace `INSTANCE_NAME` with the instance name of the directory server. This is LDAP1 in the previous sections.

2. Import the CA that has signed your certificate.

```
> sudo dsctl INSTANCE_NAME tls import-ca
/path/to/CA/in/PEM/format/CA.pem NICKNAME_FOR_CA
```

Replace `INSTANCE_NAME` with the instance name of the directory server. Replace `/path/to/CA/in/PEM/format/CA.pem` with the full path to the CA certificate file in PEM format. Replace `NICKNAME_FOR_CA` with a nickname for the CA.

3. Import the server certificate and the key for the certificate.

```
> sudo dsctl INSTANCE_NAME tls import-server-key-cert
/path/to/SERVER.pem /path/to/SERVER.key
```

Replace `INSTANCE_NAME` with the instance name of the directory server. Replace `/path/to/SERVER.pem` with the full path to the server certificate in PEM format. Replace `/path/to/SERVER.key` with the full path to the server certificate key file in PEM format.

4. Restart the instance so that the new certificates are used.

```
> sudo systemctl restart dirsrv@INSTANCE-NAME.service
```

Replace `INSTANCE_NAME` with the instance name of the directory server.

5.11 Setting up replication

389 Directory Server supports replicating its database content between multiple servers. According to the type of replication, this provides:

- Faster performance and response times
- Fault tolerance and failover
- Load balancing
- High availability

A database is the smallest unit of a directory that can be replicated. You can replicate an entire database, but not a subtree within a database. One database must correspond to one suffix. You cannot replicate a suffix that is distributed over two or more databases.

A replica that sends data to another replica is a supplier. A replica that receives data from a supplier is a consumer. Replication is always initiated by the supplier, and a single supplier can send data to multiple consumers. The supplier is a read-write replica, and the consumer is read-only, except in the case of multi-supplier replication. In multi-supplier replication the suppliers are both suppliers and consumers of the same data.

5.11.1 Asynchronous writes

389 DS manages replication differently than other databases. Replication is asynchronous, and eventually consistent. This means:

- Any write or change to a single server is immediately accepted.
- There is a delay between a write finishing on one server, and then replicating and being visible on other servers.
- If that write conflicts with writes on other servers, it may be rolled back at some point in the future.
- Not all servers may show identical content at the same time due to replication delay.

As LDAP is “low-write,” these factors mean that all servers are at least up to a common baseline of a known consistent state. Small changes occur on top of this baseline, so many of these aspects of delayed replication are not perceived in day to day usage.

5.11.2 Designing your topology

Consider the following factors when you are designing your replication topology.

- The need for replication: high availability, geo-location, read scaling, or a combination of all.
- How many replicas (nodes, servers) you plan to have in your topology.
- Direction of data flows, both inside of the topology, and data flowing into the topology.
- How clients balance across nodes of the topology for their requests (multiple ldap URIs, SRV records, load balancers).

These factors all affect how you may create your topology. (See [Section 5.11.3, “Example replication topologies”](#) for topology examples.)

5.11.3 Example replication topologies

The following sections provide examples of replication topologies, using two to six 389 Directory Server nodes. The maximum number of supported supplier replicas in a topology is 20. Operational experience shows the optimal number for replication efficiency is a maximum of eight.

5.11.3.1 Two replicas

EXAMPLE 5.4: TWO SUPPLIER REPLICAS



In [Example 5.4, “Two supplier replicas”](#) there are two replicas, S1 and S2, which replicate bi-directionally between each other, so they are both suppliers and consumers. S1 and S2 could be in separate data centers, or in the same data center. Clients can balance across the servers using LDAP URIs, a load balancer, or DNS SRV records. This is the simplest topology for high availability. Each server needs to be able to provide 100% of client load, in case the other server is offline for any reason. A two-node replication is generally not adequate for horizontal read scaling, as a single node handles all read requests if the other node is offline.



Note: Default topology

The two-node topology should be considered the default topology, because it is the simplest to manage. You can expand your topology over time, as necessary.

5.11.3.2 Four supplier replicas

EXAMPLE 5.5: FOUR SUPPLIER REPLICAS

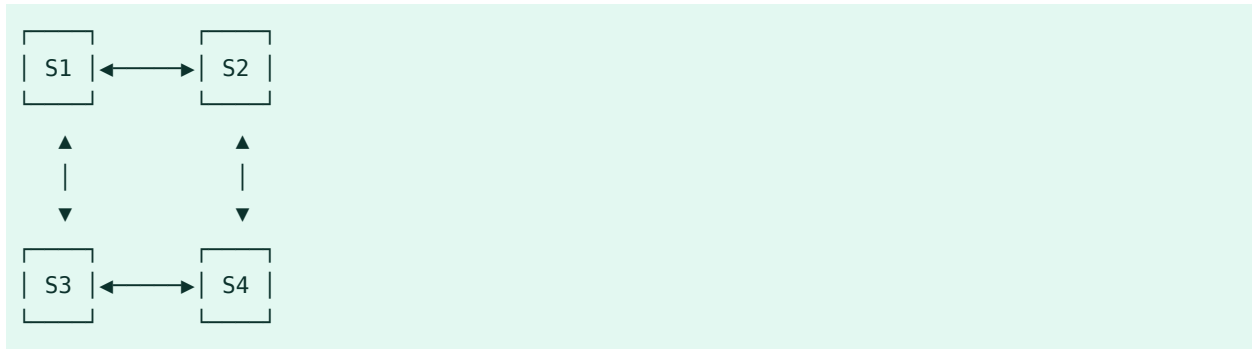

Example 5.5, "Four supplier replicas" has four supplier replicas, which all synchronize to each other. These could be in four datacenters, or two servers per datacenter. In the case of one node per data center, each node should be able to support 100% of client load. When there are two per datacenter, each one only needs to scale to 50% of the client load.

5.11.3.3 Six replicas

EXAMPLE 5.6: SIX REPLICAS

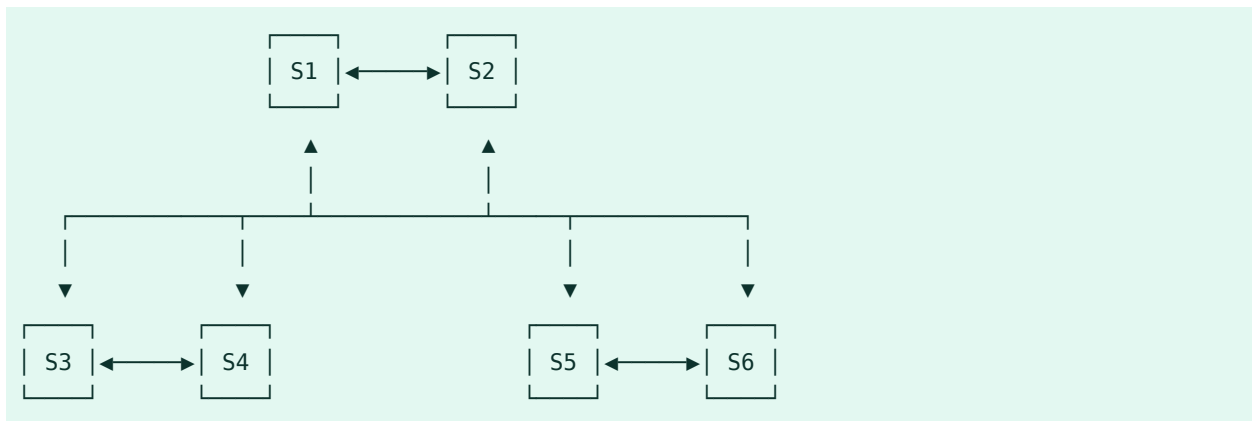

In *Example 5.6, "Six replicas"*, each pair is in a separate location. S1 and S2 are the suppliers, and S3, S4, S5, and S6 are consumers of S1 and S2. Each pair of servers replicate to each other. S3, S4, S5 and S6 can accept writes, though most of the replication is done through S1 and S2. This setup provides geographic separation for high availability and scaling.

5.11.3.4 Six replicas with read-only consumers

EXAMPLE 5.7: SIX REPLICAS WITH READ-ONLY CONSUMERS

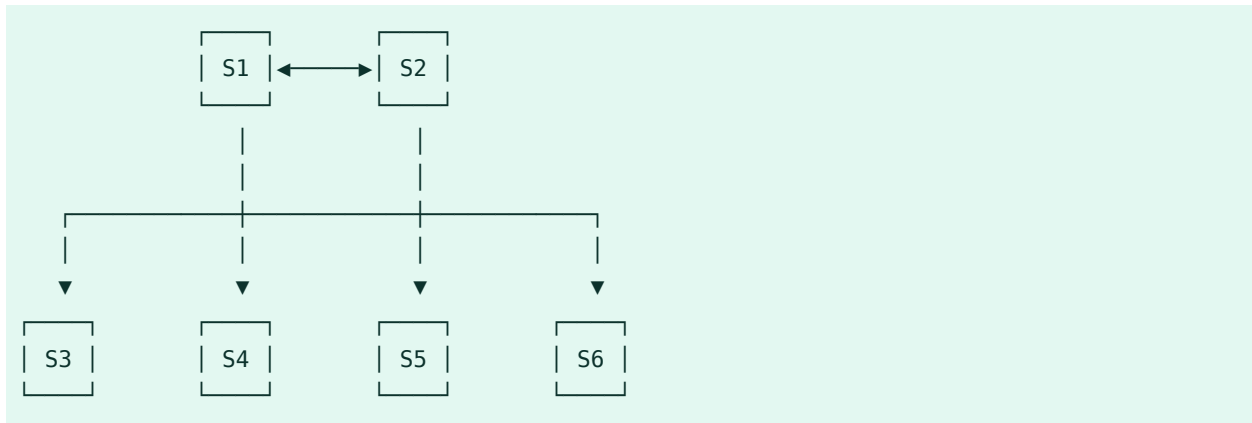

In *Example 5.7, "Six replicas with read-only consumers"*, S1 and S2 are the suppliers, and the other four servers are read-only consumers. All changes occur on S1 and S2, and are propagated to the four replicas. Read-only consumers can be configured to store only a subset of the database, or partial entries, to limit data exposure. You could have a fractional read-only server in a DMZ, for example, so that if data is exposed, changes can not propagate back to the other replicas.

5.11.4 Terminology

In the example topologies we have seen that 389 DS can take on a number of roles in a topology. The following list clarifies the terminology.

Replica

An instance of 389 DS with an attached database.

Read-write replica

A replica with a full copy of a database, that accepts read and write operations.

Read-only replica

A replica with a full copy of a database, that only accepts read operations.

Fractional read-only replica

A replica with a partial copy of a database, that only accepts read- only operations.

Supplier

A replica that supplies data from its database to another replica.

Consumer

A replica that receives data from another replica to write into its database.

Replication agreement

The configuration of a server defining its supplier and consumer relation to another replica.

Topology

A set of replicas connected via replication agreements.

Replica ID

A unique identifier of the 389 Directory Server instance within the replication topology.

Replication manager

An account with replication rights in the directory.

5.11.5 Configuring replication

The first example sets up a two node bi-directional replication with a single read-only server, as a minimal starting example. In the following examples, the host names of the two read-write nodes are RW1 and RW2, and the read-only server is RO1. (Use your own host names.)

All servers should have a back-end with an identical suffix. Only one server, RW1, needs an initial copy of the database.

5.11.5.1 Configuring two-node replication

The following commands configure the read-write replicas in a two-node setup (*Example 5.4, "Two supplier replicas"*), with the host names RW1 and RW2. (Use your own host names.)



Warning: Create a strong replication manager password

The replication manager should be considered equivalent to the directory manager in terms of security and access, and should have a strong password.

If you create different replication manager passwords for each server, be sure to keep track of which password belongs to which server. For example, when you configure the outbound connection in RW1's replication agreement, you need to set the replication manager password to the RW2 replication manager password.

First, configure RW1:

```
> sudo dsconf INSTANCE-NAME replication create-manager
> sudo dsconf INSTANCE-NAME replication enable \
--suffix dc=example,dc=com \
--role supplier --replica-id 1 --bind-dn "cn=replication manager,cn=config"
```

Configure RW2:

```
> sudo dsconf INSTANCE-NAME replication create-manager
> sudo dsconf INSTANCE-NAME replication enable \
--suffix dc=example,dc=com \
--role supplier --replica-id 2 --bind-dn "cn=replication manager,cn=config"
```

This will create the replication metadata required on RW1 and RW2. Note the difference in the `replica-id` between the two servers. This also creates the replication manager account, which is an account with replication rights for authenticating between the two nodes.

RW1 and RW2 are now both configured to have replication metadata. The next step is to create the first agreement for outbound data from RW1 to RW2.

```
> sudo dsconf INSTANCE-NAME repl-agmt create \
--suffix dc=example,dc=com \
--host=RW2 --port=636 --conn-protocol LDAPS --bind-dn "cn=replication manager,cn=config" \
--bind-passwd PASSWORD --bind-method SIMPLE RW1_to_RW2
```

Data does not flow from RW1 to RW2 until after a full synchronization of the database, which is called an initialization or reinit. This resets all database content on RW2 to match the content of RW1. Run the following command to trigger a reinit of the data:

```
> sudo dsconf INSTANCE-NAME repl-agmt init \
--suffix dc=example,dc=com RW1_to_RW2
```

Check the status by running this command on RW1:

```
> sudo dsconf INSTANCE-NAME repl-agmt init-status \
--suffix dc=example,dc=com RW1_to_RW2
```

When it is finished, you should see an Agreement successfully initialized message. If you get an error message, check the errors log. Otherwise, you should see the identical content from RW1 on RW2.

Finally, to make this bi-directional, configure a replication agreement from RW2 outbound to RW1:

```
> sudo dsconf INSTANCE-NAME repl-agmt create \  
--suffix dc=example,dc=com \  
--host=RW1 --port=636 --conn-protocol LDAPS \  
--bind-dn "cn=replication manager,cn=config" --bind-passwd PASSWORD \  
--bind-method SIMPLE RW2_to_RW1
```

Changes made on either RW1 or RW2 are now replicated to the other. Check replication status on either server with the following command:

```
> sudo dsconf INSTANCE-NAME repl-agmt status \  
--suffix dc=example,dc=com \  
--bind-dn "cn=replication manager,cn=config" \  
--bind-passwd PASSWORD RW2_to_RW1
```

5.11.5.2 Configuring a read-only node

To create a read-only node, start by creating the replication manager account and metadata. The hostname of the example server is RO3:



Warning: Create a strong replication manager password

The replication manager should be considered equivalent to the directory manager in terms of security and access, and should have a strong password.

If you create different replication manager passwords for each server, be sure to keep track of which password belongs to which server. For example, when you configure the outbound connection in RW1's replication agreement, you need to set the replication manager password to the RW2 replication manager password.

```
> sudo dsconf INSTANCE_NAME replication create-manager  
> sudo dsconf INSTANCE_NAME \  
replication enable --suffix dc=EXAMPLE,dc=COM \  
--role consumer --bind-dn "cn=replication manager,cn=config"
```

For a read-only replica, you do not provide a replica-id, and the role is set to `consumer`. This allocates a special read-only replica-id for all read-only replicas. After the read-only replica is created, add the replication agreements from RW1 and RW2 to the read-only instance. The following example is on RW1:

```
> sudo dsconf INSTANCE_NAME \
repl-agmt create --suffix dc=EXAMPLE,dc=COM \
--host=R03 --port=636 --conn-protocol LDAPS \
--bind-dn "cn=replication manager,cn=config" --bind-passwd PASSWORD \
--bind-method SIMPLE RW1_to_R03
```

The following example, on RW2, configures the replication agreement between RW2 and RO3:

```
> sudo dsconf INSTANCE_NAME repl-agmt create \
--suffix dc=EXAMPLE,dc=COM \
--host=R03 --port=636 --conn-protocol LDAPS \
--bind-dn "cn=replication manager,cn=config" --bind-passwd PASSWORD \
--bind-method SIMPLE RW2_to_R03
```

After these steps are completed, you can use either RW1 or RW2 to perform the initialization of the database on RO3. The following example initializes RO3 from RW2:

```
> sudo dsconf INSTANCE_NAME repl-agmt init
--suffix dc=EXAMPLE,dc=COM RW2_to_R03
```

5.11.6 Monitoring and healthcheck

The `dsconf` command includes a monitoring option. You can check the status of each replica status directly on the replicas, or from other hosts. The following example commands are run on RW1, checking the status on two remote replicas, and then on itself:

```
> sudo dsconf -D "cn=Directory Manager" ldap://RW2 replication monitor
> sudo dsconf -D "cn=Directory Manager" ldap://R03 replication monitor
> sudo dsconf -D "cn=Directory Manager" ldap://RW1 replication monitor
```

The `dsctl` command has a `healthcheck` option. The following example runs a replication healthcheck on the local 389 DS instance:

```
> sudo dsctl INSTANCE_NAME healthcheck --check replication
```

Use the `-v` option for verbosity, to see what the healthcheck examines:

```
> sudo dsctl -v INSTANCE_NAME healthcheck --check replication
```

Run `dsctl INSTANCE_NAME healthcheck` with no options for a general health check.

Run the following command to see a list of the checks that healthcheck performs:

```
> sudo dsctl INSTANCE_NAME healthcheck --list-checks
config:hr_timestamp
config:passwordscheme
backends:userroot:cl_trimming
backends:userroot:mappingtree
backends:userroot:search
backends:userroot:virt_attrs
encryption:check_tls_version
fschecks:file_perms
[...]
```

You can run one or more of the individual checks:

```
> sudo dsctl INSTANCE_NAME healthcheck \
--check monitor-disk-space:disk_space tls:certificate_expiration
```

5.11.7 Making backups

When replication is enabled, you need to adjust your 389 Directory Server backup strategy (see [Section 5.5, “Backing up and restoring 389 Directory Server”](#) to learn about making backups). If you are using `db2ldif`, you must add the `--replication` flag to ensure that replication metadata is backed up. You should backup all servers in the topology. When restoring from backup, start by restoring a single node of the topology, then reinitialize all other nodes as new instances.

5.11.8 Pausing and resuming replication

You can pause replication during maintenance windows, or anytime you need to stop it. A node of the topology can only be offline for a maximum of days up to the limit of the changelog (see [Section 5.11.9, “Changelog max-age”](#)).

Use the `repl-agmt` command to pause replication. The following example is on RW2:

```
> sudo dsconf INSTANCE_NAME repl-agmt disable \
--suffix dc=EXAMPLE,dc=COM RW2_to_RW1
```

The following example re-enables replication:

```
> sudo dsconf INSTANCE_NAME repl-agmt enable \
--suffix dc=EXAMPLE,dc=COM RW2_to_RW1
```

5.11.9 Changelog max-age

A replica can be offline for up to the length of time defined by the changelog `max-age` option. `max-age` defines the maximum age of any entry in the changelog. Any items older than the `max-age` value are automatically removed.

After the replica comes back online, it synchronizes with the other replicas. If it is offline for longer than the `max-age` value, the replica needs to be re-initialized and refuses to accept or provide changes to other nodes, as they may be inconsistent. The following example sets the `max-age` to seven days:

```
> sudo dsconf INSTANCE_NAME \
  replication set-changelog --max-age 7d \
  --suffix dc=EXAMPLE,dc=COM
```

5.11.10 Removing a replica

To remove a replica, first fence the node to prevent any incoming changes or reads. Then, find all servers that have incoming replication agreements with the node you are removing, and remove them. The following example removes RW2. Start by disabling the outbound replication agreement on RW1:

```
> sudo dsconf INSTANCE_NAME repl-agmt delete \
  --suffix dc=EXAMPLE,dc=COM RW1_to_RW2
```

On the replica you are removing, which in the following example is RW2, remove all outbound agreements:

```
> sudo dsconf INSTANCE_NAME repl-agmt delete \
  --suffix dc=EXAMPLE,dc=COM RW2_to_RW1
> sudo dsconf INSTANCE_NAME repl-agmt delete \
  --suffix dc=EXAMPLE,dc=COM RW2_to_R03
```

Stop the instance on RW2:

```
> sudo systemctl stop dirsrv@INSTANCE_NAME.service
```

Then run the `cleanallruv` command to remove the replica ID from the topology. The following example is run on RW1:

```
> sudo dsconf INSTANCE_NAME repl-tasks cleanallruv \
  --suffix dc=EXAMPLE,dc=COM --replica-id 2
> sudo dsconf INSTANCE_NAME repl-tasks list-cleanruv-tasks
```

5.11.11 Limitations on replication of 389 Directory Server

The use of 389 Directory Server is supported within the following replication limits:

- A maximum of 8 read-write nodes
- A maximum of 20 replication hubs
- A maximum of 100 read-only servers
- A maximum of 1 Winsync Active Directory consumer as a read-write node member

5.12 Synchronizing with Microsoft Active Directory

389 Directory Server supports synchronizing certain user and group content from Microsoft's Active Directory, so that Linux clients can use 389 DS for their identity information without the normally required domain join process. This also allows 389 DS to extend and use its other features with the data synchronized from Active Directory.

5.12.1 Planning your synchronization topology

Due to how the synchronization works, only a single 389 Directory Server and Active Directory server are involved. The Active Directory server must be a full Domain Controller, and not a Read Only Domain Controller (RODC). The Global Catalog is not required on the DC that is synchronized, as 389 DS only replicates the content of a single forest in a domain.

You must first choose the direction of your data flow. There are three options: from AD to 389 DS, from 389 DS to AD, or bi- directional.



Note: No password synchronization

Passwords cannot be synchronized between 389 DS and Active Directory. This may change in the future, to support Active Directory to 389 DS password flow.

Your topology looks like the following diagram. The 389 Directory Server and Active Directory topologies may differ, but the most important factor is to have only a single connection between 389 DS and Active Directory. It is important to account for this in your disaster recovery and backup plans for both 389 DS and AD, to ensure that you correctly restore only a single replication connection between these topologies.

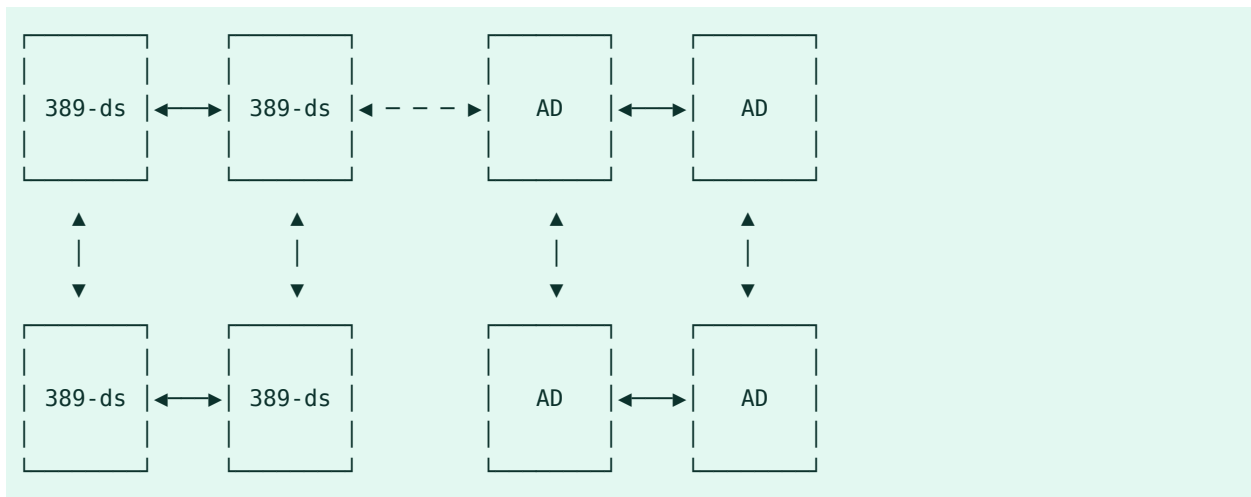

5.12.2 Prerequisites for Active Directory

A security group that is granted the Replicating Directory Changes permission is required. For example, you have created a group named Directory Server Sync. Follow the steps in the *How to grant the 'Replicating Directory Changes' permission for the Microsoft Metadirectory Services ADMA service account* (<https://docs.microsoft.com/en-US/troubleshoot/windows-server/windows-security/grant-replicating-directory-changes-permission-adma-service> ⁷) to set this up.



Warning: Strong security needed

You should consider members of this group to be of equivalent security importance to Domain Administrators. Members of this group have the ability to read sensitive content from the Active Directory environment, so you should use strong, randomly generated service account passwords for these accounts, and carefully audit membership to this group.

You should also create a service account that is a member of this group.

Your Active Directory environment must have certificates configured for LDAPS to ensure that authentication between 389 DS and AD is secure. Authentication with Generic Security Services API/Kerberos (GSSAPI/KRB) cannot be used.

5.12.3 Prerequisites for 389 Directory Server

The 389 Directory Server must have a back-end database already configured with Organization Units (OUs) for entries to be synchronized into.

The 389 Directory Server must have a replica ID configured as though the server is a read-write replica. (For details about setting up replication see [Section 5.11, "Setting up replication"](#)).

5.12.4 Creating an agreement from Active Directory to 389 Directory Server

The following example command, which is run on the 389 Directory Server, creates a replication agreement from Active Directory to 389 Directory Server:

```
> sudo dsconf INSTANCE-NAME repl-winsync-agmt create --suffix dc=example,dc=com \  
  --host AD-HOSTNAME --port 636 --conn-protocol LDAPS \  
  --bind-dn "cn=SERVICE-ACCOUNT,cn=USERS,dc=AD,dc=EXAMPLE,dc=COM" \  
  --bind-passwd "PASSWORD" --win-subtree "cn=USERS,dc=AD,dc=EXAMPLE,dc=COM" \  
  --ds-subtree ou=AD,dc=EXAMPLE,dc=COM --one-way-sync fromWindows \  
  --sync-users=on --sync-groups=on --move-action delete \  
  --win-domain AD-DOMAIN adsync_agreement
```

Once the agreement has been created, you must perform an initial resynchronization:

```
> sudo dsconf INSTANCE-NAME repl-winsync-agmt init --suffix dc=example,dc=com  
adsync_agreement
```

Use the following command to check the status of the initialization:

```
> sudo dsconf INSTANCE-NAME repl-winsync-agmt init-status --suffix dc=example,dc=com  
adsync_agreement
```



Note: Some entries are not synchronized

In some cases, an entry may not be synchronized, even if the init status reports success. Check your 389 DS log files in [/var/log/dirsrv/slapd-INSTANCE-NAME/errors](#).

Check the status of the agreement with the following command:

```
> sudo dsconf INSTANCE-NAME repl-winsync-agmt status --suffix dc=example,dc=com  
adsync_agreement
```

When you are performing maintenance on the Active Directory or 389 Directory Server topology, you can pause the agreement with the following command:

```
> sudo dsconf INSTANCE-NAME repl-winsync-agmt disable --suffix dc=example,dc=com  
adsync_agreement
```

Resume the agreement with the following command:

```
> sudo dsconf INSTANCE-NAME repl-winsync-agmt enable --suffix dc=example,dc=com  
adsync_agreement
```

5.13 More information

For more information about 389 Directory Server, see:

- The upstream documentation at <https://www.port389.org/docs/389ds/documentation.html>.
- man dsconf
- man dsctl
- man dsidm
- man dscreate

6 Network authentication with Kerberos

Kerberos is a network authentication protocol which also provides encryption. This chapter describes how to set up Kerberos and integrate services like LDAP and NFS.

6.1 Conceptual overview

An open network provides no means of ensuring that a workstation can identify its users properly, except through the usual password mechanisms. In common installations, the user must enter the password each time a service inside the network is accessed. Kerberos provides an authentication method with which a user registers only once and is trusted in the complete network for the rest of the session. To have a secure network, the following requirements must be met:

- Have all users prove their identity for each desired service and make sure that no one can take the identity of someone else.
- Make sure that each network server also proves its identity. Otherwise an attacker might be able to impersonate the server and obtain sensitive information transmitted to the server. This concept is called *mutual authentication*, because the client authenticates to the server and vice versa.

Kerberos helps you meet these requirements by providing strongly encrypted authentication. Only the basic principles of Kerberos are discussed here. For detailed technical instruction, refer to the Kerberos documentation.

6.2 Kerberos terminology

The following glossary defines Kerberos terminology.

credential

Users or clients need to present credentials that authorize them to request services. Kerberos knows two kinds of credentials—tickets and authenticators.

ticket

A ticket is a per-server credential used by a client to authenticate at a server from which it is requesting a service. It contains the name of the server, the client's name, the client's Internet address, a time stamp, a lifetime, and a random session key. All this data is encrypted using the server's key.

authenticator

Combined with the ticket, an authenticator is used to prove that the client presenting a ticket is really the one it claims to be. An authenticator is built using the client's name, the workstation's IP address, and the current workstation's time, all encrypted with the session key known only to the client and the relevant server. An authenticator can only be used once, unlike a ticket. A client can build an authenticator itself.

principal

A Kerberos principal is a unique entity (a user or service) to which it can assign a ticket. A principal consists of the following components:

```
USER/INSTANCE@REALM
```

- **primary:** The first part of the principal. For users, this is the same as the user name.
- **instance (*optional*):** Additional information characterizing the *primary*. This string is separated from the *primary* by a `/`.
`tux@example.org` and `tux/admin@example.org` can both exist on the same Kerberos system and are treated as different principals.
- **realm:** Specifies the Kerberos realm. Normally, your realm is your domain name in uppercase letters.

mutual authentication

Kerberos ensures that both client and server can be sure of each other's identity. They share a session key, which they can use to communicate securely.

session key

Session keys are temporary private keys generated by Kerberos. They are known to the client and used to encrypt the communication between the client and the server for which it requested and received a ticket.

replay

Almost all messages sent in a network can be eavesdropped, stolen and resent. In the Kerberos context, this would be most dangerous if an attacker manages to obtain your request for a service containing your ticket and authenticator. The attacker could then try to re-send it (*replay*) to impersonate you. However, Kerberos implements several mechanisms to deal with this problem.

server or service

Service is used to refer to a specific action to perform. The process behind this action is called a *server*.

6.3 How Kerberos works

Kerberos is often called a third-party trusted authentication service, which means all its clients trust Kerberos's judgment of another client's identity. Kerberos keeps a database of all its users and their private keys.

To ensure Kerberos is working correctly, run both the authentication and ticket-granting server on a dedicated machine. Make sure that only the administrator can access this machine physically and over the network. Reduce the (networking) services running on it to the absolute minimum—do not even run `sshd`.

6.3.1 First contact

Your first contact with Kerberos is similar to any login procedure at a normal networking system. Enter your user name. This piece of information and the name of the ticket-granting service are sent to the authentication server (Kerberos). If the authentication server knows you, it generates a random session key for further use between your client and the ticket-granting server. Now the authentication server prepares a ticket for the ticket-granting server. The ticket contains the following information—all encrypted with a session key only the authentication server and the ticket-granting server know:

- The names of both, the client and the ticket-granting server
- The current time
- A lifetime assigned to this ticket

- The client's IP address
- The newly generated session key

This ticket is then sent back to the client together with the session key, again in encrypted form, but this time the private key of the client is used. This private key is only known to Kerberos and the client, because it is derived from your user password. Now that the client has received this response, you are prompted for your password. This password is converted into the key that can decrypt the package sent by the authentication server. The package is “unwrapped” and password and key are erased from the workstation's memory. As long as the lifetime given to the ticket used to obtain other tickets does not expire, your workstation can prove your identity.

6.3.2 Requesting a service

To request a service from any server in the network, the client application needs to prove its identity to the server. Therefore, the application generates an authenticator. An authenticator consists of the following components:

- The client's principal
- The client's IP address
- The current time
- A checksum (chosen by the client)

All this information is encrypted using the session key that the client has already received for this special server. The authenticator and the ticket for the server are sent to the server. The server uses its copy of the session key to decrypt the authenticator, which gives it all the information needed about the client requesting its service, to compare it to that contained in the ticket. The server checks if the ticket and the authenticator originate from the same client.

Without any security measures implemented on the server side, this stage of the process would be an ideal target for replay attacks. Someone could try to resend a request stolen off the net some time before. To prevent this, the server does not accept any request with a time stamp and ticket received previously. A request with a time stamp differing too much from the time the request is received is ignored.

6.3.3 Mutual authentication

Kerberos authentication can be used in both directions. It is not only a question of the client being the one it claims to be. The server should also be able to authenticate itself to the client requesting its service. Therefore, it sends an authenticator itself. It adds one to the checksum it received in the client's authenticator and encrypts it with the session key, which is shared between it and the client. The client takes this response as a proof of the server's authenticity and they both start cooperating.

6.3.4 Ticket granting—contacting all servers

Tickets are designed to be used for one server at a time. Therefore, you need to get a new ticket each time you request another service. Kerberos implements a mechanism to obtain tickets for individual servers. This service is called the “ticket-granting service”. The ticket-granting service is a service (like any other service mentioned before) and uses the same access protocols that have already been outlined. Any time an application needs a ticket that has not already been requested, it contacts the ticket-granting server. This request consists of the following components:

- The requested principal
- The ticket-granting ticket
- An authenticator

Like any other server, the ticket-granting server now checks the ticket-granting ticket and the authenticator. If they are considered valid, the ticket-granting server builds a new session key to be used between the original client and the new server. Then the ticket for the new server is built, containing the following information:

- The client's principal
- The server's principal
- The current time
- The client's IP address
- The newly generated session key

The new ticket has a lifetime, which is either the remaining lifetime of the ticket-granting ticket or the default for the service. The lesser of both values is assigned. The client receives this ticket and the session key, which are sent by the ticket-granting service. But this time the answer is encrypted with the session key that came with the original ticket-granting ticket. The client can decrypt the response without requiring the user's password when a new service is contacted. Kerberos can thus acquire ticket after ticket for the client without bothering the user.

6.4 User view of Kerberos

Ideally, a user only contact with Kerberos happens during login at the workstation. The login process includes obtaining a ticket-granting ticket. At logout, a user's Kerberos tickets are automatically destroyed, which makes it difficult for anyone else to impersonate this user.

The automatic expiration of tickets can lead to a situation when a user's login session lasts longer than the maximum lifespan given to the ticket-granting ticket (a reasonable setting is 10 hours). However, the user can get a new ticket-granting ticket by running `kinit`. Enter the password again and Kerberos obtains access to desired services without additional authentication. To get a list of all the tickets silently acquired for you by Kerberos, run `klist`.

Here is a short list of applications that use Kerberos authentication. These applications can be found under `/usr/lib/mit/bin` or `/usr/lib/mit/sbin` after installing the package `krb5-apps-clients`. They all have the full functionality of their common Unix and Linux brothers plus the additional bonus of transparent authentication managed by Kerberos:

- `telnet`, `telnetd`
- `rlogin`
- `rsh`, `rcp`, `rshd`
- `ftp`, `ftpd`
- `ksu`

You no longer need to enter your password for using these applications because Kerberos has already proven your identity. `ssh`, if compiled with Kerberos support, can even forward all the tickets acquired for one workstation to another one. If you use `ssh` to log in to another workstation, `ssh` makes sure that the encrypted contents of the tickets are adjusted to the new situation. Simply copying tickets between workstations is not sufficient because the ticket con-

tains workstation-specific information (the IP address). XDM and GDM offer Kerberos support, too. Read more about the Kerberos network applications in *Kerberos V5 UNIX User's Guide* at <https://web.mit.edu/kerberos>.

6.5 Installing and administering Kerberos

A Kerberos environment consists of several components. A key distribution center (KDC) holds the central database with all Kerberos-relevant data. All clients rely on the KDC for proper authentication across the network. Both the KDC and the clients need to be configured to match your setup:

General preparations

Check your network setup and make sure it meets the minimum requirements outlined in *Section 6.5.1, "Kerberos network topology"*. Choose an appropriate realm for your Kerberos setup, see *Section 6.5.2, "Choosing the Kerberos realms"*. Carefully set up the machine that is to serve as the KDC and apply tight security, see *Section 6.5.3, "Setting up the KDC hardware"*. Set up a reliable time source in your network to make sure all tickets contain valid time stamps, see *Section 6.5.4, "Configuring time synchronization"*.

Basic configuration

Configure the KDC and the clients, see *Section 6.5.5, "Configuring the KDC"* and *Section 6.5.6, "Configuring Kerberos clients"*. Enable remote administration for your Kerberos service, so you do not need physical access to your KDC machine, see *Section 6.5.7, "Configuring remote Kerberos administration"*. Create service principals for every service in your realm, see *Section 6.5.8, "Creating Kerberos service principals"*.

Enabling Kerberos authentication

Various services in your network can use Kerberos. To add Kerberos password-checking to applications using PAM, proceed as outlined in *Section 6.5.9, "Enabling PAM support for Kerberos"*. To configure SSH or LDAP with Kerberos authentication, proceed as outlined in *Section 6.5.10, "Configuring SSH for Kerberos authentication"* and *Section 6.5.11, "Using LDAP and Kerberos"*.

6.5.1 Kerberos network topology

Any Kerberos environment must meet the following requirements to be fully functional:

- Provide a DNS server for name resolution across your network, so clients and servers can locate each other. Refer to *Book "Administration Guide", Chapter 39 "The domain name system"* for information on DNS setup.
- Provide a time server in your network. Using exact time stamps is crucial to a Kerberos setup, because valid Kerberos tickets must contain correct time stamps. Refer to *Book "Administration Guide", Chapter 38 "Time synchronization with NTP"* for information on NTP setup.
- Provide a key distribution center (KDC) as the center piece of the Kerberos architecture. It holds the Kerberos database. Use the tightest possible security policy on this machine to prevent any attacks on this machine compromising your entire infrastructure.
- Configure the client machines to use Kerberos authentication.

The following figure depicts a simple example network with only the minimum components needed to build a Kerberos infrastructure. Depending on the size and topology of your deployment, your setup may vary.

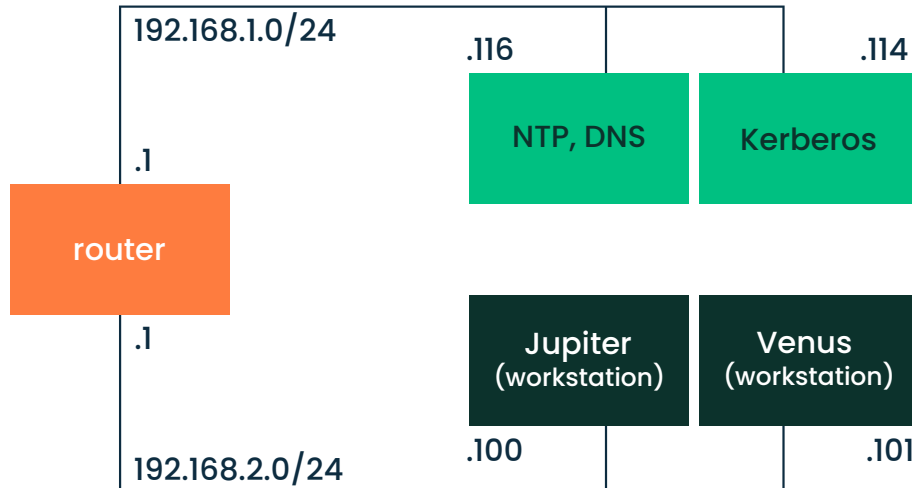

FIGURE 6.1: KERBEROS NETWORK TOPOLOGY



Tip: Configuring subnet routing

For a setup similar to the one in [Figure 6.1, “Kerberos network topology”](#), configure routing between the two subnets (192.168.1.0/24 and 192.168.2.0/24). Refer to *Book “Administration Guide”, Chapter 23 “Basic networking”, Section 23.4.1.5 “Configuring routing”* for more information on configuring routing with YaST.

6.5.2 Choosing the Kerberos realms

The domain of a Kerberos installation is called a realm and is identified by a name, such as `EXAMPLE.COM` or simply `ACCOUNTING`. Kerberos is case-sensitive, so `example.com` is a different realm than `EXAMPLE.COM`. Use the case you prefer. However, it is common practice to use uppercase realm names.

It is also a good idea to use your DNS domain name (or a subdomain, such as `ACCOUNTING.EXAMPLE.COM`). As shown below, your life as an administrator can be much easier if you configure your Kerberos clients to locate the KDC and other Kerberos services via DNS. To do so, it is helpful if your realm name is a subdomain of your DNS domain name.

Unlike the DNS name space, Kerberos is not hierarchical. So if you have a realm named `EXAMPLE.COM` with two “subrealms” named `DEVELOPMENT` and `ACCOUNTING`, these subordinate realms do not inherit principals from `EXAMPLE.COM`. Instead, you would have three separate realms, and you would need to configure cross-realm authentication for each realm, so that users from one realm can interact with servers or other users from another realm.

For the sake of simplicity, let us assume you are setting up only one realm for your entire organization. For the remainder of this section, the realm name `EXAMPLE.COM` is used in all examples.

6.5.3 Setting up the KDC hardware

The first thing required to use Kerberos is a machine that acts as the key distribution center, or KDC for short. This machine holds the entire Kerberos user database with passwords and all information.

The KDC is the most important part of your security infrastructure—if someone breaks into it, all user accounts and your infrastructure protected by Kerberos is compromised. An attacker with access to the Kerberos database can impersonate any principal in the database. Tighten security for this machine as much as possible:

1. Put the server machine into a physically secured location, such as a locked server room to which only a few people have access.
2. Do not run any network applications on it except the KDC. This includes servers and clients—for example, the KDC should not import any file systems via NFS or use DHCP to retrieve its network configuration.
3. Install a minimal system first then check the list of installed packages and remove any unneeded packages. This includes servers, such as `inetd`, `portmap`, and CUPS, plus anything X-based. Even installing an SSH server should be considered a potential security risk.
4. No graphical login is provided on this machine as an X server is a potential security risk. Kerberos provides its own administration interface.
5. Configure `/etc/nsswitch.conf` to use only local files for user and group lookup. Change the lines for `passwd` and `group` to look like this:

```
passwd:      files
group:       files
```

Edit the `passwd`, `group`, and `shadow` files in `/etc` and remove the lines that start with a `+` character (these are for NIS lookups).

6. Disable all user accounts except `root`'s account by editing `/etc/shadow` and replacing the hashed passwords with `*` or `!` characters.

6.5.4 Configuring time synchronization

To use Kerberos successfully, make sure that all system clocks within your organization are synchronized within a certain range. This is important because Kerberos protects against replayed credentials. An attacker might be able to observe Kerberos credentials on the network and reuse them to attack the server. Kerberos employs several defenses to prevent this. One of them is that it puts time stamps into its tickets. A server receiving a ticket with a time stamp that differs from the current time rejects the ticket.

Kerberos allows a certain leeway when comparing time stamps. However, computer clocks can be inaccurate in keeping time—it is not unheard of for PC clocks to lose or gain half an hour during a week. For this reason, configure all hosts on the network to synchronize their clocks with a central time source.

A simple way to do so is by installing an NTP time server on one machine and having all clients synchronize their clocks with this server. Do this by running an NTP daemon `chronyd` as a client on all these machines. The KDC itself needs to be synchronized to the common time source as well. Because running an NTP daemon on this machine would be a security risk, it is a good idea to do this by running `chronyd -q` via a cron job. To configure your machine as an NTP client, proceed as outlined in *Book “Administration Guide”, Chapter 38 “Time synchronization with NTP”, Section 38.1 “Configuring an NTP client with YaST”*.

A different way to secure the time service and still use the NTP daemon is to attach a hardware reference clock to a dedicated NTP server and an additional hardware reference clock to the KDC.

It is also possible to adjust the maximum deviation Kerberos allows when checking time stamps. This value (called *clock skew*) can be set in the `krb5.conf` file as described in [Section 6.5.6.3, “Adjusting the clock skew”](#).

6.5.5 Configuring the KDC

This section covers the initial configuration and installation of the KDC, including the creation of an administrative principal. This procedure consists of several steps:

1. **Install the RPMs.** On a machine designated as the KDC, install the following software packages: `krb5`, `krb5-server` and `krb5-client` packages.
2. **Adjust the configuration files.** The `/etc/krb5.conf` and `/var/lib/kerberos/krb5kdc/kdc.conf` configuration files must be adjusted for your scenario. These files contain all information on the KDC. See [Section 6.5.5.1, “Configuring the server”](#).
3. **Create the Kerberos database.** Kerberos keeps a database of all principal identifiers and the secret keys of all principals that need to be authenticated. Refer to [Section 6.5.5.2, “Setting up the database”](#) for details.
4. **Adjust the ACL files: add administrators.** The Kerberos database on the KDC can be managed remotely. To prevent unauthorized principals from tampering with the database, Kerberos uses access control lists. You must explicitly enable remote access for the ad-

administrator principal to enable them to manage the database. The Kerberos ACL file is located under `/var/lib/kerberos/krb5kdc/kadm5.acl`. Refer to [Section 6.5.7, “Configuring remote Kerberos administration”](#) for details.

5. **Adjust the Kerberos database: add administrators.** You need at least one administrative principal to run and administer Kerberos. This principal must be added before starting the KDC. Refer to [Section 6.5.5.3, “Creating a principal”](#) for details.
6. **Start the Kerberos daemon.** After the KDC software is installed and properly configured, start the Kerberos daemon to provide Kerberos service for your realm. Refer to [Section 6.5.5.4, “Starting the KDC”](#) for details.
7. **Create a principal for yourself.** You need a principal for yourself. Refer to [Section 6.5.5.3, “Creating a principal”](#) for details.

6.5.5.1 Configuring the server

Configuring a Kerberos server is highly variable, dependent on your network architecture, DNS and DHCP configuration, realms and other considerations. You must have a default realm, and domain- to-realm mappings. The following example demonstrates a minimal configuration. This is not a copy-and-paste example; see https://web.mit.edu/kerberos/krb5-latest/doc/admin/conf_files/index.html for detailed information on Kerberos configuration.

EXAMPLE 6.1: EXAMPLE KDC CONFIGURATION, /etc/krb5.conf

```
[libdefaults]
dns_canonicalize_hostname = false
rdns = false
default_realm = example.com
ticket_lifetime = 24h
renew_lifetime = 7d

[realms]
example.com = {
kdc = kdc.example.com.:88
admin_server = kdc.example.com
default_domain = example.com
}

[logging]
kdc = FILE:/var/log/krb5kdc.log
admin_server = FILE:/var/log/kadmind.log
default = SYSLOG:NOTICE:DAEMON

[domain_realm]
.example.com = example.com
example.com = example.com
```

6.5.5.2 Setting up the database

Your next step is to initialize the database where Kerberos keeps all information about principals. Set up the database master key, which is used to protect the database from accidental disclosure (in particular if it is backed up to tape). The master key is derived from a pass phrase and is stored in a file called the stash file. This is so you do not need to enter the password every time the KDC is restarted. Make sure that you choose a good pass phrase, such as a sentence from a book opened to a random page.

When you make tape backups of the Kerberos database (`/var/lib/kerberos/krb5kdc/principal`), do not back up the stash file (which is in `/var/lib/kerberos/krb5kdc/.k5.EXAMPLE.COM`). Otherwise, everyone able to read the tape could also decrypt the database. Therefore, keep a copy of the pass phrase in a safe or another secure location, because you need it to restore your database from backup tape after a crash.

To create the stash file and the database, run:

```
> sudo kdb5_util create -r EXAMPLE.COM -s
```

You see the following output:

```
Initializing database '/var/lib/kerberos/krb5kdc/principal' for realm 'EXAMPLE.COM',
master key name 'K/M@EXAMPLE.COM'
You are prompted for the database Master Password.
It is important that you NOT FORGET this password.
Enter KDC database master key: ❶
Re-enter KDC database master key to verify: ❷
```

- ❶ Type the master password.
- ❷ Type the password again.

To verify, use the list command:

```
> kadmin.local

kadmin> listprincs
```

You see several principals in the database, which are for internal use by Kerberos:

```
K/M@EXAMPLE.COM
kadmin/admin@EXAMPLE.COM
kadmin/changepw@EXAMPLE.COM
krbtgt/EXAMPLE.COM@EXAMPLE.COM
```

6.5.5.3 Creating a principal

Create two Kerberos principals for yourself: one normal principal for everyday work and one for administrative tasks relating to Kerberos. Assuming your login name is suzanne, proceed as follows:

```
> kadmin.local

kadmin> ank suzanne
```

You see the following output:

```
suzanne@EXAMPLE.COM's Password: ❶
Verifying password: ❷
```

- ❶ Type >suzanne's password.
- ❷ Type suzanne's password again.

Next, create another principal named `suzanne/admin` by typing **ank** `suzanne/admin` at the **kadmin** prompt. The `admin` suffixed to your user name is a *role*. Later, use this role when administering the Kerberos database. A user can have several roles for different purposes. Roles act like different accounts that have similar names.

6.5.5.4 Starting the KDC

Start the KDC daemon and the kadmin daemon. To start the daemons manually, enter:

```
> sudo systemctl start krb5kdc
sudo systemctl start kadmind
```

Also make sure that the services KDC (`krb5kdc`) and kadmind (`kadmind`) are started by default when the server machine is rebooted. Enable them by entering:

```
> sudo systemctl enable krb5kdc kadmind
```

or by using the YaST *Services Manager*.

6.5.6 Configuring Kerberos clients

When the supporting infrastructure is in place (DNS, NTP) and the KDC has been properly configured and started, configure the client machines. To configure a Kerberos client, use one of the two manual approaches described below.

When configuring Kerberos, there are two approaches you can take—static configuration in the `/etc/krb5.conf` file or dynamic configuration with DNS. With DNS configuration, Kerberos applications try to locate the KDC services using DNS records. With static configuration, add the host names of your KDC server to `krb5.conf` (and update the file whenever you move the KDC or reconfigure your realm in other ways).

DNS-based configuration is generally a lot more flexible and the amount of configuration work per machine is a lot less. However, it requires that your realm name is either the same as your DNS domain or a subdomain of it. Configuring Kerberos via DNS also creates a security issue: An attacker can seriously disrupt your infrastructure through your DNS (by shooting down the name server, spoofing DNS records, etc.). However, this amounts to a denial of service at worst. A similar scenario applies to the static configuration case unless you enter IP addresses in `krb5.conf` instead of host names.

6.5.6.1 Static configuration

One way to configure Kerberos is to edit `/etc/krb5.conf`. The file installed by default contains sample entries. Erase all of these entries before starting. `krb5.conf` is made up of several sections (stanzas), each introduced by the section name in brackets like `[this]`.

To configure your Kerberos clients, add the following stanza to `krb5.conf` (where `kdc.example.com` is the host name of the KDC):

```
[libdefaults]
    default_realm = EXAMPLE.COM

[realms]
    EXAMPLE.COM = {
        kdc = kdc.example.com
        admin_server = kdc.example.com
    }
```

The `default_realm` line sets the default realm for Kerberos applications. If you have several realms, add additional statements to the `[realms]` section.

Also add a statement to this file that tells applications how to map host names to a realm. For example, when connecting to a remote host, the Kerberos library needs to know in which realm this host is located. This must be configured in the `[domain_realms]` section:

```
[domain_realm]
.example.com = EXAMPLE.COM
www.example.org = EXAMPLE.COM
```

This tells the library that all hosts in the `example.com` DNS domains are in the `EXAMPLE.COM` Kerberos realm. One external host named `www.example.org` should also be considered a member of the `EXAMPLE.COM` realm.

6.5.6.2 DNS-based configuration

DNS-based Kerberos configuration makes heavy use of SRV records. See *(RFC2052) A DNS RR for specifying the location of services* at <https://datatracker.ietf.org/doc/html/rfc2052>.

The name of an SRV record, as far as Kerberos is concerned, is always in the format `_service._proto.realm`, where `realm` is the Kerberos realm. Domain names in DNS are case-insensitive, so case-sensitive Kerberos realms would break when using this configuration method. `_service` is a service name (different names are used when trying to contact the KDC or the password service, for example). `_proto` can be either `_udp` or `_tcp`, but not all services support both protocols.

The data portion of SRV resource records consists of a priority value, a weight, a port number, and a host name. The priority defines the order in which hosts should be tried (lower values indicate a higher priority). The weight value is there to support load balancing among servers of equal priority. You probably do not need any of this, so it is okay to set these to zero.

MIT Kerberos currently looks up the following names when looking for services:

_kerberos

This defines the location of the KDC daemon (the authentication and ticket granting server). Typical records look like this:

```
_kerberos._udp.EXAMPLE.COM. IN SRV 0 0 88 kdc.example.com.  
_kerberos._tcp.EXAMPLE.COM. IN SRV 0 0 88 kdc.example.com.
```

_kerberos-adm

This describes the location of the remote administration service. Typical records look like this:

```
_kerberos-adm._tcp.EXAMPLE.COM. IN SRV 0 0 749 kdc.example.com.
```

Because `kadmind` does not support UDP, there should be no `_udp` record.

As with the static configuration file, there is a mechanism to inform clients that a specific host is in the `EXAMPLE.COM` realm, even if it is not part of the `example.com` DNS domain. This can be done by attaching a TXT record to `_kerberos.host_name`, as shown here:

```
_kerberos.www.example.org. IN TXT "EXAMPLE.COM"
```

6.5.6.3 Adjusting the clock skew

The *clock skew* is the tolerance for accepting tickets with time stamps that do not exactly match the host's system clock. The clock skew is set to 300 seconds (five minutes). This means a ticket can have a time stamp somewhere between five minutes behind and five minutes ahead of the server's clock.

When using NTP to synchronize all hosts, you can reduce this value to about one minute. The clock skew value can be set in `/etc/krb5.conf` like this:

```
[libdefaults]  
    clockskew = 60
```

6.5.7 Configuring remote Kerberos administration

To be able to add and remove principals from the Kerberos database without accessing the KDC's console directly, tell the Kerberos administration server which principals are allowed to do what by editing `/var/lib/kerberos/krb5kdc/kadm5.acl`. The ACL (access control list) file allows you to specify privileges with a precise degree of control. For details, refer to the manual page with `man 8 kadmind`.

For now, grant yourself the privilege to administer the database by putting the following line into the file:

```
suzanne/admin          *
```

Replace the user name `suzanne` with your own. Restart `kadmind` for the change to take effect. You should now be able to perform Kerberos administration tasks remotely using the `kadmin` tool. First, obtain a ticket for your admin role and use that ticket when connecting to the `kadmin` server:

```
> kadmin -p suzanne/admin
Authenticating as principal suzanne/admin@EXAMPLE.COM with password.
Password for suzanne/admin@EXAMPLE.COM:
kadmin: getprivs
current privileges: GET ADD MODIFY DELETE
kadmin:
```

Using the `getprivs` command, verify which privileges you have. The list shown above is the full set of privileges.

As an example, modify the principal `suzanne`:

```
> kadmin -p suzanne/admin
Authenticating as principal suzanne/admin@EXAMPLE.COM with password.
Password for suzanne/admin@EXAMPLE.COM:

kadmin: getprinc suzanne
Principal: suzanne@EXAMPLE.COM
Expiration date: [never]
Last password change: Wed Jan 12 17:28:46 CET 2005
Password expiration date: [none]
Maximum ticket life: 0 days 10:00:00
Maximum renewable life: 7 days 00:00:00
Last modified: Wed Jan 12 17:47:17 CET 2005 (admin/admin@EXAMPLE.COM)
Last successful authentication: [never]
Last failed authentication: [never]
```

```

Failed password attempts: 0
Number of keys: 2
Key: vno 1, Triple DES cbc mode with HMAC/sha1, no salt
Key: vno 1, DES cbc mode with CRC-32, no salt
Attributes:
Policy: [none]

kadmin: modify_principal -maxlife "8 hours" suzanne
Principal "suzanne@EXAMPLE.COM" modified.
kadmin: getprinc suzanne
Principal: suzanne@EXAMPLE.COM
Expiration date: [never]
Last password change: Wed Jan 12 17:28:46 CET 2005
Password expiration date: [none]
Maximum ticket life: 0 days 08:00:00
Maximum renewable life: 7 days 00:00:00
Last modified: Wed Jan 12 17:59:49 CET 2005 (suzanne/admin@EXAMPLE.COM)
Last successful authentication: [never]
Last failed authentication: [never]
Failed password attempts: 0
Number of keys: 2
Key: vno 1, Triple DES cbc mode with HMAC/sha1, no salt
Key: vno 1, DES cbc mode with CRC-32, no salt
Attributes:
Policy: [none]
kadmin:

```

This changes the maximum ticket life time to eight hours. For more information about the `kadmin` command and the options available, see the `krb5-doc` package or refer to the [man 8 kadmin](#) manual page.

6.5.8 Creating Kerberos service principals

So far, only user credentials have been discussed. However, Kerberos-compatible services need to authenticate themselves to the client user, too. Therefore, special service principals must be in the Kerberos database for each service offered in the realm. For example, if `ldap.example.com` offers an LDAP service, you need a service principal, `ldap/ldap.example.com@EXAMPLE.COM`, to authenticate this service to all clients.

The naming convention for service principals is `SERVICE/HOSTNAME@REALM`, where `HOSTNAME` is the host's fully qualified host name.

Valid service descriptors are:

Service Descriptor	Service
<u>host</u>	Telnet, RSH, SSH
<u>nfs</u>	NFSv4 (with Kerberos support)
<u>HTTP</u>	HTTP (with Kerberos authentication)
<u>imap</u>	IMAP
<u>pop</u>	POP3
<u>ldap</u>	LDAP

Service principals are similar to user principals, but have significant differences. The main difference between a user principal and a service principal is that the key of the former is protected by a password. When a user obtains a ticket-granting ticket from the KDC, they need to type their password, so Kerberos can decrypt the ticket. It would be inconvenient for system administrators to obtain new tickets for the SSH daemon every eight hours or so.

Instead, the key required to decrypt the initial ticket for the service principal is extracted by the administrator from the KDC only once and stored in a local file called the *keytab*. Services such as the SSH daemon read this key and use it to obtain new tickets automatically, when needed. The default keytab file resides in /etc/krb5.keytab.

To create a host service principal for jupiter.example.com enter the following commands during your *kadmin* session:

```
> kadmin -p suzanne/admin
Authenticating as principal suzanne/admin@EXAMPLE.COM with password.
Password for suzanne/admin@EXAMPLE.COM:
kadmin: addprinc -randkey host/jupiter.example.com
WARNING: no policy specified for host/jupiter.example.com@EXAMPLE.COM;
defaulting to no policy
Principal "host/jupiter.example.com@EXAMPLE.COM" created.
```

Instead of setting a password for the new principal, the -randkey flag tells *kadmin* to generate a random key. This is used here because no user interaction is wanted for this principal. It is a server account for the machine.

Finally, extract the key and store it in the local keytab file `/etc/krb5.keytab`. This file is owned by the superuser, so you must be `root` to execute the next command in the `kadmin` shell:

```
kadmin: ktadd host/jupiter.example.com
Entry for principal host/jupiter.example.com with kvno 3, encryption type Triple
DES cbc mode with HMAC/sha1 added to keytab WRFILE:/etc/krb5.keytab.
Entry for principal host/jupiter.example.com with kvno 3, encryption type DES
cbc mode with CRC-32 added to keytab WRFILE:/etc/krb5.keytab.
kadmin:
```

When completed, make sure that you destroy the admin ticket obtained with `kinit` above with `kdestroy`.

6.5.9 Enabling PAM support for Kerberos



Warning: Incomplete configuration locks users out

An incomplete Kerberos configuration may lock you out of your system, including the root user. To prevent this, add the `ignore_unknown_principals` directive to the `pam_krb5` module *after* you have added the `pam_krb5` module to the existing PAM configuration files as described below.

```
> sudo pam-config --add --krb5-ignore_unknown_principals
```

This directs the `pam_krb5` module to ignore errors that would otherwise cause the account phase to fail.

SUSE® Linux Enterprise Server comes with a PAM module named `pam_krb5`, which supports Kerberos login and password update. This module can be used by applications such as console login, `su`, and graphical login applications like GDM. That is, it can be used in all cases where the user enters a password and expects the authenticating application to obtain an initial Kerberos ticket on their behalf. To configure PAM support for Kerberos, use the following command:

```
> sudo pam-config --add --krb5
```

The above command adds the `pam_krb5` module to the existing PAM configuration files and makes sure it is called in the right order. To make precise adjustments to how `pam_krb5` is used, edit the file `/etc/krb5.conf` and add default applications to PAM. For details, refer to the manual page with `man 5 pam_krb5`.

The `pam_krb5` module was specifically not designed for network services that accept Kerberos tickets as part of user authentication. This is an entirely different matter, and is discussed below.

6.5.10 Configuring SSH for Kerberos authentication

OpenSSH supports Kerberos authentication in both protocol version 1 and 2. In version 1, there are special protocol messages to transmit Kerberos tickets. Version 2 does not use Kerberos directly anymore, but relies on GSSAPI, the General Security Services API. This is a programming interface that is not specific to Kerberos—it was designed to hide the peculiarities of the underlying authentication system, be it Kerberos, a public-key authentication system like SPKM, or others. However, the included GSSAPI library only supports Kerberos.

To use `sshd` with Kerberos authentication, edit `/etc/ssh/sshd_config` and set the following options:

```
# These are for protocol version 1
#
# KerberosAuthentication yes
# KerberosTicketCleanup yes

# These are for version 2 - better to use this
GSSAPIAuthentication yes
GSSAPICleanupCredentials yes
```

Then restart your SSH daemon using `sudo systemctl restart sshd`.

To use Kerberos authentication with protocol version 2, enable it on the client side as well. Do this either in the system-wide configuration file `/etc/ssh/ssh_config` or on a per-user level by editing `~/.ssh/config`. In both cases, add the option `GSSAPIAuthentication yes`.

You should now be able to connect using Kerberos authentication. Use `klist` to verify that you have a valid ticket, then connect to the SSH server. To force SSH protocol version 1, specify the `-1` option on the command line.



Tip: More information

The file `/usr/share/doc/packages/openssh/README.kerberos` discusses the interaction of OpenSSH and Kerberos in more detail.



Tip: Additional directives for protocol version 2

The `GSSAPIKeyExchange` mechanism (RFC 4462) is supported. This directive specifies how host keys are exchanged. For more information, see the `sshd_config` manual page (`man sshd_config`).

6.5.11 Using LDAP and Kerberos

While Kerberos provides authentication, LDAP is used for authorization and identification. Both services can work together.

For secure connections, 389 Directory Server supports different ways of encrypting data: SSL/TLS connections, Start TLS connections, and SASL authentication. Simple Authentication and Security Layer (SASL) is a network protocol designed for authentication. The SASL implementation used on SUSE Linux Enterprise Server is `cyrus-sasl`. Kerberos authentication is performed through GSS-API (General Security Services API), provided by the `cyrus-sasl-gssapi` package. Using GSS-API, 389 Directory Server uses Kerberos tickets to authenticate sessions and encrypt data.

With the SASL framework you can use different mechanisms to authenticate a user to the server. In Kerberos, authentication is always mutual. This means that not only have you authenticated yourself to the 389 Directory Server, but also the 389 Directory Server has authenticated itself to you. In particular, this means communication is with the desired server, rather than with a random service set up by an attacker.

To enable Kerberos to bind to the 389 Directory Server, create a principal `ldap/ldap.example.com` and add that to the keytab. The credentials used by the 389 Directory Server to authenticate are given to other servers by the keytab. 389 Directory Server assigns a keytab through the `KRB5_KTNAME` environment variable.

To set the variable, proceed as follows:

1.

```
> sudo systemctl edit dirsrv@INSTANCE
```

If you used the default name for the 389 Directory Server instance, replace `INSTANCE` with `localhost`.

2. Add the following:

```
[Service]
Environment=KRB5_KTNAME=/etc/dirsrv/slapd-INSTANCE/krb5.keytab
```

3. The keytab file needs to be readable by the account under which the 389 Directory Server runs (for example, `dirserv`):

```
> sudo chown dirsrv:dirsrv /etc/dirsrv/slapd-INSTANCE/krb5.keytab
> sudo chmod 600 /etc/dirsrv/slapd-INSTANCE/krb5.keytab
```

6.5.11.1 Using Kerberos authentication with LDAP

To obtain and cache an initial ticket-granting ticket, use the principal that has been created in [Section 6.5.5.3, "Creating a principal"](#):

```
> kinit suzanne@EXAMPLE.COM
```

To check if GSSAPI authentication works, run:

```
> ldapwhoami -Y GSSAPI -H ldap://ldapkdc.example.com
dn: uid=testuser,ou=People,dc=example,dc=com
```

GSSAPI uses the `ccache` to authenticate the user to the 389 Directory Server without the user's password.

6.5.11.2 Configuring SASL identity mapping

When processing a SASL bind request, the 389 Directory Server maps the SASL authentication ID (used to authenticate to the Directory Server) with an LDAP entry stored within the server. When using Kerberos, the SASL user ID has the following format: `userid@REALM`, such as `tux@example.com`. This ID must be converted into the DN of the user's Directory Server entry, such as `uid=tux,ou=people,dc=example,dc=com`. The 389 Directory Server comes with default maps for most common configurations. However, you can create customized maps. [Procedure 6.1, "Managing maps"](#) shows how to list and display a map, how to delete a map and how to create a custom map.

1. To list the existing SASL maps:

```
> dsconf INSTANCE sasl list
Kerberos uid mapping
rfc 2829 dn syntax
rfc 2829u syntax
uid mapping
```

2. To display a map:

```
> sudo dsconf INSTANCE sasl get "Kerberos uid mapping"
dn: cn=Kerberos uid mapping,cn=mapping,cn=sasl,cn=config
cn: Kerberos uid mapping
nsSaslMapBaseDNTemplate: dc=\2,dc=\3
nsSaslMapFilterTemplate: (uid=\1)
nsSaslMapRegexString: \(.*\)\@(.*)\.\(.*\)
objectClass: top
objectClass: nsSaslMapping
```

3. The default map only works if your dc has two components. To delete the map (if it does not work for you):

```
> sudo dsconf INSTANCE sasl delete "Kerberos uid mapping"
Deleting SaslMapping cn=Kerberos uid mapping,cn=mapping,cn=sasl,cn=config :
Successfully deleted cn=Kerberos uid mapping,cn=mapping,cn=sasl,cn=config
```

4. To create a new map:

```
> sudo dsconf localhost sasl create --cn=bhgssapi --nsSaslMapRegexString "\
(.*)@EXAMPLE.NET.DE" --nsSaslMapBaseDNTemplate="dc=example,dc=net,dc=de" --
nsSaslMapFilterTemplate="(uid=\1)"
> sudo Enter value for nsSaslMapPriority :
Successfully created bhgssapi
```

5. Display the newly created map with:

```
> sudo dsconf localhost sasl get "bhgssapi"
dn: cn=bhgssapi,cn=mapping,cn=sasl,cn=config
cn: bhgssapi
nsSaslMapBaseDNTemplate: dc=example,dc=net,dc=de
nsSaslMapFilterTemplate: (uid=\1)
nsSaslMapPriority: 100
nsSaslMapRegexString: \(.*)@EXAMPLE.NET.DE
objectClass: top
```

```
objectClass: nsSaslMapping
```

With this, you can check only the users of a specific realm and remap them to a different dc base. As you can see, the new map has 3 `dc` components, so the default maps would not have worked for this realm (`EXAMPLE.NET.DE`), only for a realm like `EXAMPLE.NET`.

6.6 Kerberos and NFS

Most NFS servers can export file systems using any combination of the default “trust the network” form of security, known as `sec=sys`, and three different levels of Kerberos-based security, `sec=krb5`, `sec=krb5i`, and `sec=krb5p`. The `sec` option is set as a mount option on the client. It is often the case that the NFS service is configured first and used with `sec=sys`, and then Kerberos can be imposed afterwards. In this case it is likely that the server is configured to support both `sec=sys` and one of the Kerberos levels, and then after all clients have transitioned, the `sec=sys` support is removed, thus achieving true security. The transition to Kerberos should be transparent if done in an orderly manner. However there is one subtle detail of NFS behavior that works differently when Kerberos is used, and the implications of this need to be understood and addressed. See [Section 6.6.1, “Group membership”](#).

The three Kerberos levels indicate different levels of security. With more security comes a need for more processor power to encrypt and decrypt messages. Choosing the right balance is an important consideration when planning a roll-out of Kerberos for NFS.

`krb5` provides only authentication. The server can know who sent a request, and the client can know that the server sent a reply. No security is provided for the content of the request or reply, so an attacker with physical network access could transform the request or reply, or both, in various ways to deceive either server or client. They cannot directly read or change any file that the authenticated user could not read or change, but almost anything is theoretically possible.

`krb5i` adds integrity checks to all messages. With `krb5i`, an attacker cannot modify any request or reply, but they can view all the data exchanged, and so could discover the content of any file that is read.

`krb5p` adds privacy to the protocol. As well as reliable authentication and integrity checking, messages are fully encrypted so an attacker can only know that messages were exchanged between client and server, and cannot extract other information directly from the message. Whether information can be extracted from message timing is a separate question that Kerberos does not address.

6.6.1 Group membership

The one behavioral difference between `sec=sys` and the Kerberos security levels that might be visible is related to group membership. In Unix and Linux, each file system access comes from a process that is owned by a particular user and has a particular group owner and several supplemental groups. Access rights to files can vary based on the owner and the groups.

With `sec=sys`, the user-id, group-id, and a list of up to 16 supplementary groups are sent to the server in each request.

If a user is a member of more than 16 supplementary groups, the extra groups are lost and files may not be accessible over NFS that the user would normally expect to have access to. For this reason, most sites that use NFS find a way to limit all users to at most 16 supplementary groups. If the user runs the `newgrp` command or runs a `set-group-id` program, either of which can change the list of groups they are a member of, these changes take effect immediately and provide different accesses over NFS.

With Kerberos, group information is not sent in requests. Only the user is identified (using a Kerberos “principal”), and the server performs a lookup to determine the user ID and group list for that principal. This means that if the user is a member of more than 16 groups, these group memberships are used in determining file access permissions. However it also means that if the user changes a group-id on the client, the server does not notice the change and does not take it into account in determining access rights.

The improvement of having access to more groups brings a real benefit, and the loss of not being able to change groups is not noticed as it is not widely used. A site administrator considering the use of Kerberos should be aware of the difference though and ensure that it does not cause problems.

6.6.2 Performance and scalability

Using Kerberos for security requires extra CPU power for encrypting and decrypting messages. How much extra CPU power is required and whether the difference is noticeable varies with different hardware and different applications. If the server or client are already saturating the available CPU power, it is likely that a performance drop is measurable when switching from `sec=sys` to Kerberos. If there is spare CPU capacity available, it is possible that the transition does not result in any throughput change. The only way to be sure how much impact the use of Kerberos has is to test your load on your hardware.

The only configuration options that might reduce the load also reduce the quality of the protection offered. `sec=krb5` should produce noticeably less load than `sec=krb5p` but, as discussed above, it does not produce strong security. Similarly it is possible to adjust the list of ciphers that Kerberos can choose from, and this might change the CPU requirement. However the defaults are carefully chosen and should not be changed without similar careful consideration.

The other possible performance issue when configuring NFS to use Kerberos involves availability of the Kerberos authentication servers, known as the KDC or Key Distribution Center.

The use of NFS adds load to such servers to the same degree that adding the use of Kerberos for any other services adds some load. Every time a given user (Kerberos principal) establishes a session with a service, for example by accessing files exported by a particular NFS server, the client needs to negotiate with the KDC. Once a session key has been negotiated, the client server can communicate without further help for many hours, depending on details of the Kerberos configuration, particularly the `ticket_lifetime` setting.

The concerns most likely to affect the provisioning of Kerberos KDC servers are availability and peak usage.

As with other core services such as DNS, LDAP or similar name-lookup services, having two servers that are reasonably “close” to every client provides good availability for modest resources. Kerberos allows for multiple KDC servers with flexible models for database propagation, so distributing servers as needed around campuses, buildings and even cabinets is straightforward. The best mechanism to ensure each client finds a nearby Kerberos server is to use split-horizon DNS with each building (or similar) getting different details from the DNS server. If this is not possible, then managing the `/etc/krb5.conf` file to be different at different locations is a suitable alternative.

As access to the Kerberos KDC is infrequent, load is only likely to be a problem at peak times. If thousands of people all log in between 9:00 and 9:05, then the servers receive many more requests-per-minute than they might in the middle of the night. The load on the Kerberos server is likely to be more than that on an LDAP server, but not orders of magnitude more. A sensible guideline is to provision Kerberos replicas in the same manner that you provision LDAP replicas, and then monitor performance to determine if demand ever exceeds capacity.

6.6.3 Master KDC, multiple domains, and trust relationships

One service of the Kerberos KDC that is not easily distributed is the handling of updates, such as password changes and new user creation. These must happen at a single master KDC.

These updates are not likely to happen with such frequency that any significant load is generated, but availability could be an issue. It can be annoying to create a new user or change a password, and the master KDC on the other side of the world is temporarily unavailable.

When an organization is geographically distributed and has a policy of handling administration tasks locally at each site, it can be beneficial to create multiple Kerberos domains, one for each administrative center. Each domain would then have its own master KDC which would be geographically local. Users in one domain can still get access to resources in another domain by setting up trust relationships between domains.

The easiest arrangement for multiple domains is to have a global domain (for example, EXAMPLE.COM) and local domains (for example, ASIA.EXAMPLE.COM, EUROPE.EXAMPLE.COM). If the global domain is configured to trust each local domain, and each local domain is configured to trust the global domain, then fully transitive trust is available between any pair of domains, and any principal can establish a secure connection with any service. Ensuring appropriate access rights to resources, for example files provided by that service, depends on the user name lookup service used, and the functionality of the NFS file server, and is beyond the scope of this document.

6.7 More information

The official site of MIT Kerberos is <https://web.mit.edu/kerberos>. There, find links to any other relevant resource concerning Kerberos, including Kerberos installation, user, and administration guides.

The book *Kerberos—A Network Authentication System* by Brian Tung (ISBN 0-201-37924-4) offers extensive information.

7 Active Directory support

Active Directory* (AD) is a directory-service based on LDAP, Kerberos, and other services. It is used by Microsoft* Windows* to manage resources, services, and people. In a Microsoft Windows network, Active Directory provides information about these objects, restricts access to them, and enforces policies. SUSE® Linux Enterprise Server lets you join existing Active Directory domains and integrate your Linux machine into a Windows environment.

7.1 Integrating Linux and Active Directory environments

With a Linux client (configured as an Active Directory client) that is joined to an existing Active Directory domain, benefit from various features not available on a pure SUSE Linux Enterprise Server Linux client:

Browsing shared files and directories with SMB

GNOME Files (previously called Nautilus) supports browsing shared resources through SMB.

Sharing files and directories with SMB

GNOME Files supports sharing directories and files as in Windows.

Accessing and manipulating user data on the Windows server

Through GNOME Files, users can access their Windows user data and can edit, create, and delete files and directories on the Windows server. Users can access their data without having to enter their password multiple times.

Offline authentication

Users can log in and access their local data on the Linux machine even if they are offline or the Active Directory server is unavailable for other reasons.

Windows password change

This part of Active Directory support in Linux enforces corporate password policies stored in Active Directory. The display managers and console support password change messages and accept your input. You can even use the Linux `passwd` command to set Windows passwords.

Single sign-on through kerberized applications

Many desktop applications are Kerberos-enabled (*kerberized*), which means they can transparently handle authentication for the user without the need for password reentry at Web servers, proxies, groupware applications, or other locations.



Note: Managing Unix attributes from Windows Server* 2016 and later

In Windows Server 2016 and later, Microsoft has removed the role *IDMU/NIS Server* and along with it the *Unix Attributes* plug-in for the *Active Directory Users and Computers* MMC snap-in.

However, Unix attributes can still be managed manually when *Advanced Options* are enabled in the *Active Directory Users and Computers* MMC snap-in. For more information, see <https://blogs.technet.microsoft.com/activedirectoryua/2016/02/09/identity-management-for-unix-idmu-is-deprecated-in-windows-server/>.

Alternatively, use the method described in *Procedure 7.1, "Joining an Active Directory domain using User logon management"* to complete attributes on the client side (in particular, see *Step 6.c*).

The following section contains technical background for most of the previously named features.

7.2 Background information for Linux Active Directory support

Many system components need to interact flawlessly to integrate a Linux client into an existing Windows Active Directory domain. The following sections focus on the underlying processes of the key events in Active Directory server and client interaction.

To communicate with the directory service, the client needs to share at least two protocols with the server:

LDAP

LDAP is a protocol optimized for managing directory information. A Windows domain controller with Active Directory can use the LDAP protocol to exchange directory information with the clients. To learn more about LDAP, refer to *Chapter 5, LDAP with 389 Directory Server*.

Kerberos

Kerberos is a third-party trusted authentication service. All its clients trust Kerberos authorization of another client's identity, enabling kerberized single sign-on (SSO) solutions. Windows supports a Kerberos implementation, making Kerberos SSO possible even with Linux clients. To learn more about Kerberos in Linux, refer to [Chapter 6, Network authentication with Kerberos](#).

Depending on which YaST module you use to set up Kerberos authentication, different client components process account and authentication data:

Solutions based on SSSD

- The `sssd` daemon is the central part of this solution. It handles all communication with the Active Directory server.
- To gather name service information, `sssd_nss` is used.
- To authenticate users, the `pam_sss` module for PAM is used. The creation of user homes for the Active Directory users on the Linux client is handled by `pam_mkhome-dir`.

For more information about PAM, see [Chapter 2, Authentication with PAM](#).

Solution based on Winbind (Samba)

- The `winbindd` daemon is the central part of this solution. It handles all communication with the Active Directory server.
- To gather name service information, `nss_winbind` is used.
- To authenticate users, the `pam_winbind` module for PAM is used. The creation of user homes for the Active Directory users on the Linux client is handled by `pam_mkhome-dir`.

For more information about PAM, see [Chapter 2, Authentication with PAM](#).

Figure 7.1, "Schema of Winbind-based Active Directory authentication" highlights the most prominent components of Winbind-based Active Directory authentication.

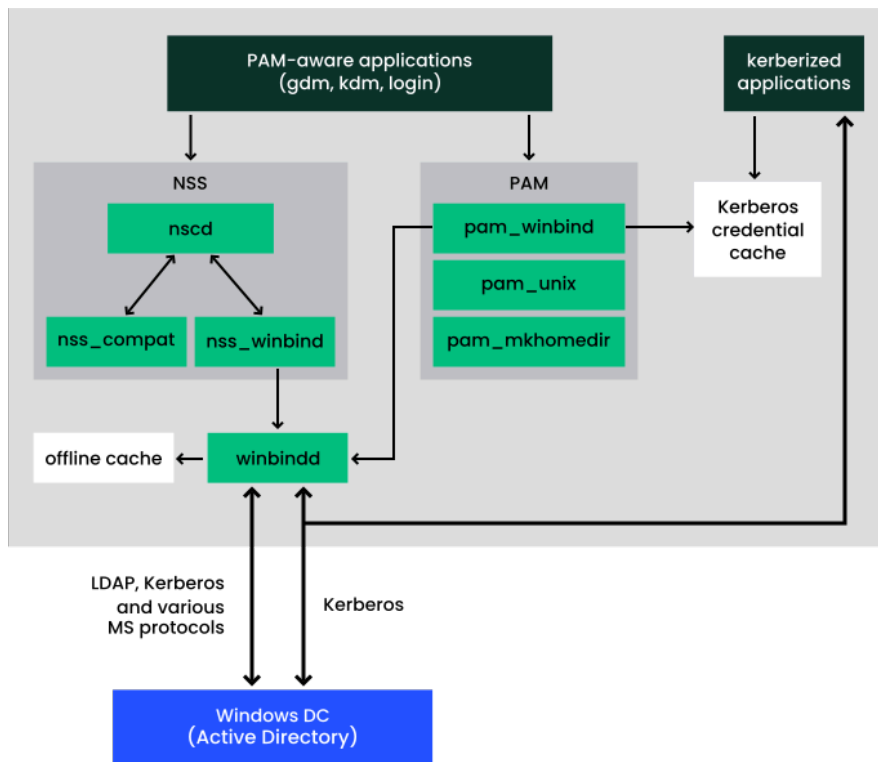

FIGURE 7.1: SCHEMA OF WINBIND-BASED ACTIVE DIRECTORY AUTHENTICATION

Applications that are PAM-aware, like the login routines and the GNOME display manager, interact with the PAM and NSS layer to authenticate against the Windows server. Applications supporting Kerberos authentication (such as file managers, Web browsers, or e-mail clients) use the Kerberos credential cache to access user's Kerberos tickets, making them part of the SSO framework.

7.2.1 Domain join

During domain join, the server and the client establish a secure relation. On the client, the following tasks need to be performed to join the existing LDAP and Kerberos SSO environment provided by the Windows domain controller. The entire join process is handled by the YaST Domain Membership module, which can be run during installation or in the installed system:

1. The Windows domain controller providing both LDAP and KDC (Key Distribution Center) services is located.
2. A machine account for the joining client is created in the directory service.

3. An initial ticket granting ticket (TGT) is obtained for the client and stored in its local Kerberos credential cache. The client needs this TGT to get further tickets allowing it to contact other services, like contacting the directory server for LDAP queries.
4. NSS and PAM configurations are adjusted to enable the client to authenticate against the domain controller.

During client boot, the winbind daemon is started and retrieves the initial Kerberos ticket for the machine account. winbindd automatically refreshes the machine's ticket to keep it valid. To keep track of the current account policies, winbindd periodically queries the domain controller.

7.2.2 Domain login and user homes

The login manager of GNOME (GDM) has been extended to allow the handling of Active Directory domain login. Users can choose to log in to the primary domain the machine has joined or to one of the trusted domains with which the domain controller of the primary domain has established a trust relationship.

User authentication is mediated by several PAM modules as described in [Section 7.2, “Background information for Linux Active Directory support”](#). If there are errors, the error codes are translated into user-readable error messages that PAM gives at login through any of the supported methods (GDM, console and SSH):

Password has expired

The user sees a message stating that the password has expired and needs to be changed. The system prompts for a new password and informs the user if the new password does not comply with corporate password policies (for example the password is too short, too simple, or already in the history). If a user's password change fails, the reason is shown and a new password prompt is given.

Account disabled

The user sees an error message stating that the account has been disabled and to contact the system administrator.

Account locked out

The user sees an error message stating that the account has been locked and to contact the system administrator.

Password has to be changed

The user can log in but receives a warning that the password needs to be changed soon. This warning is sent three days before that password expires. After expiration, the user cannot log in.

Invalid workstation

When a user is restricted to specific workstations and the current SUSE Linux Enterprise Server machine is not among them, a message appears that this user cannot log in from this workstation.

Invalid logon hours

When a user is only allowed to log in during working hours and tries to log in outside working hours, a message informs the user that logging in is not possible at that time.

Account expired

An administrator can set an expiration time for a specific user account. If that user tries to log in after expiration, the user gets a message that the account has expired and cannot be used to log in.

During a successful authentication, the client acquires a ticket granting ticket (TGT) from the Kerberos server of Active Directory and stores it in the user's credential cache. It also renews the TGT in the background, requiring no user interaction.

SUSE Linux Enterprise Server supports local home directories for Active Directory users. If configured through YaST as described in [Section 7.3, "Configuring a Linux client for Active Directory"](#), user home directories are created when a Windows/Active Directory user first logs in to the Linux client. These home directories look and feel identical to standard Linux user home directories and work independently of the Active Directory Domain Controller.

Using a local user home, it is possible to access a user's data on this machine (even when the Active Directory server is disconnected) if the Linux client has been configured to perform offline authentication.

7.2.3 Offline service and policy support

Users in a corporate environment must have the ability to become roaming users (for example, to switch networks or even work disconnected for some time). To enable users to log in to a disconnected machine, extensive caching was integrated into the winbind daemon. The winbind

daemon enforces password policies even in the offline state. It tracks the number of failed login attempts and reacts according to the policies configured in Active Directory. Offline support is disabled by default and must be explicitly enabled in the YaST Domain Membership module.

When the domain controller has become unavailable, the user can still access network resources (other than the Active Directory server itself) with valid Kerberos tickets that have been acquired before losing the connection (as in Windows). Password changes cannot be processed unless the domain controller is online. While disconnected from the Active Directory server, a user cannot access any data stored on this server. When a workstation has become disconnected from the network entirely and connects to the corporate network again later, SUSE Linux Enterprise Server acquires a new Kerberos ticket when the user has locked and unlocked the desktop (for example, using a desktop screen saver).

7.3 Configuring a Linux client for Active Directory

Before your client can join an Active Directory domain, adjustments must be made to your network setup to ensure the flawless interaction of client and server.

DNS

Configure your client machine to use a DNS server that can forward DNS requests to the Active Directory DNS server. Alternatively, configure your machine to use the Active Directory DNS server as the name service data source.

NTP

To succeed with Kerberos authentication, the client must have its time set accurately. It is recommended to use a central NTP time server for this purpose (this can be also the NTP server running on your Active Directory domain controller). If the clock skew between your Linux host and the domain controller exceeds a certain limit, Kerberos authentication fails and the client is logged in using the weaker NTLM (NT LAN Manager) authentication. For more details about using Active Directory for time synchronization, see [Procedure 7.2, "Joining an Active Directory domain using Windows domain membership"](#).

Firewall

To browse your network neighborhood, either disable the firewall entirely or mark the interface used for browsing as part of the internal zone.

To change the firewall settings on your client, log in as `root` and start the YaST firewall module. Select *Interfaces*. Select your network interface from the list of interfaces and click *Change*. Select *Internal Zone* and apply your settings with *OK*. Leave the firewall settings with *Next* > *Finish*. To disable the firewall, check the *Disable Firewall Automatic Starting* option, and leave the firewall module with *Next* > *Finish*.

Active Directory account

You cannot log in to an Active Directory domain unless the Active Directory administrator has provided you with a valid user account for that domain. Use the Active Directory user name and password to log in to the Active Directory domain from your Linux client.

7.3.1 Choosing which YaST module to use for connecting to Active Directory

YaST contains multiple modules that allow connecting to an Active Directory:

- *User logon management*. Use both an identity service (usually LDAP) and a user authentication service (usually Kerberos). This option is based on SSSD and in the majority of cases is best suited for joining Active Directory domains.

This module is described in [Section 7.3.2, “Joining Active Directory using User logon management”](#).

- *Windows domain membership*. Join an Active Directory (which entails use of Kerberos and LDAP). This option is based on `winbind` and is best suited for joining an Active Directory domain if support for NTLM or cross-forest trusts is necessary.

This module is described in [Section 7.3.3, “Joining Active Directory using Windows domain membership”](#).

7.3.2 Joining Active Directory using User logon management

The YaST module *User Logon Management* supports authentication at an Active Directory. Additionally, it also supports the following related authentication and identification providers:

Identification providers

- *Delegate to third-party software library*. Support for legacy NSS providers via a proxy.
- *FreeIPA*. FreeIPA and Red Hat Enterprise Identity Management provider.

- *Generic directory service (LDAP)*. An LDAP provider. For more information about configuring LDAP, see [man 5 sssd-ldap](#).
- *Local SSSD file database*. An SSSD-internal provider for local users.

Authentication providers

- *Delegate to third-party software library*. Relay authentication to another PAM target via a proxy.
- *FreeIPA*. FreeIPA and Red Hat Enterprise Identity Management provider.
- *Generic Kerberos service*. An LDAP provider.
- *Generic directory service (LDAP)*. Kerberos authentication.
- *Local SSSD file database*. An SSSD-internal provider for local users.
- *This domain does not provide authentication service*. Disables authentication explicitly.

To join an Active Directory domain using SSSD and the *User Logon Management* module of YaST, proceed as follows:

PROCEDURE 7.1: JOINING AN ACTIVE DIRECTORY DOMAIN USING USER LOGON MANAGEMENT

1. Open YaST.
2. To be able to use DNS auto-discovery later, set up the Active Directory Domain Controller (the Active Directory server) as the name server for your client.
 - a. In YaST, click *Network Settings*.
 - b. Select *Hostname/DNS*, then enter the IP address of the Active Directory Domain Controller into the text box *Name Server 1*.
Save the setting with *OK*.
3. From the YaST main window, start the module *User Logon Management*.
The module opens with an overview showing different network properties of your computer and the authentication method currently in use.

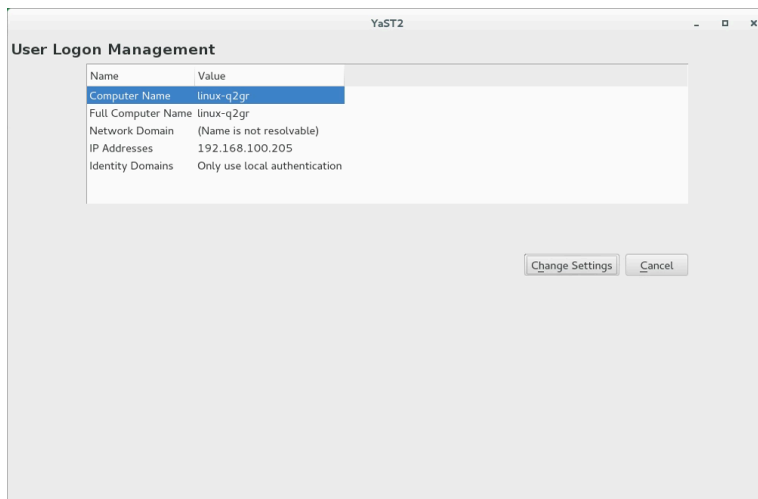

FIGURE 7.2: MAIN WINDOW OF USER LOGON MANAGEMENT

4. To start editing, click *Change Settings*.
5. Now join the domain.
 - a. Click *Add Domain*.
 - b. In the appearing dialog, specify the correct *Domain name*. Then specify the services to use for identity data and authentication: Select *Microsoft Active Directory* for both. Ensure that *Enable the domain* is activated. Click *OK*.
 - c. (*Optional*) You can keep the default settings in the following dialog. However, there are reasons to make changes:
 - If the local host name does not match the host name set on the domain controller. Find out if the host name of your computer matches the name under which your computer is known to the Active Directory Domain Controller. In a terminal, run the command `hostname`, then compare its output to the configuration of the Active Directory Domain Controller. If the values differ, specify the host name from the Active Directory configuration under *AD hostname*. Otherwise, leave the appropriate text box empty.
 - If you do not want to use DNS auto-discovery. Specify the *Host names of Active Directory servers* that you want to use. If there are multiple Domain Controllers, separate their host names with commas.

d. To continue, click *OK*.

If not all software is installed already, the computer now installs missing software. It then checks whether the configured Active Directory Domain Controller is available.

e. If everything is correct, the following dialog should now show that it has discovered an *Active Directory Server* but that you are *Not yet enrolled*.

In the dialog, specify the *Username* and *Password* of the Active Directory administrator account (Administrator).

To make sure that the current domain is enabled for Samba, activate *Overwrite Samba configuration to work with this AD*.

To enroll, click *OK*.

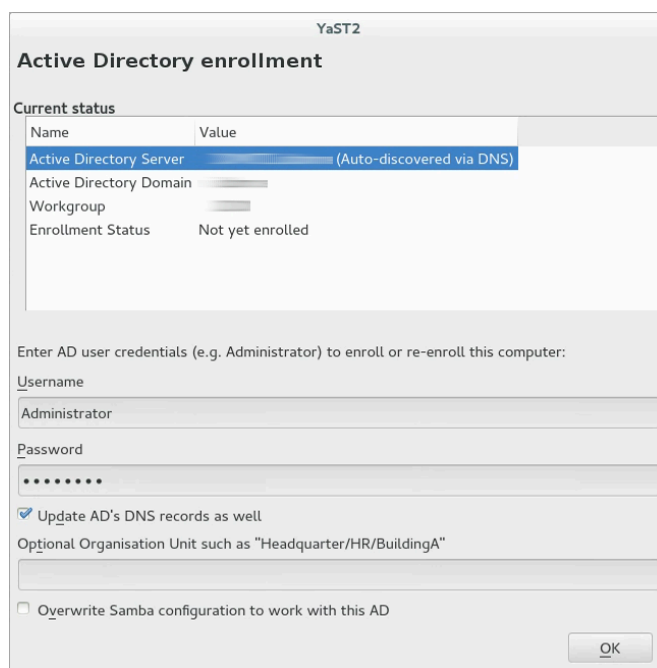

FIGURE 7.3: ENROLLING INTO A DOMAIN

f. You should now see a message confirming that you have enrolled successfully. Finish with *OK*.

6. After enrolling, configure the client using the window *Manage Domain User Logon*.

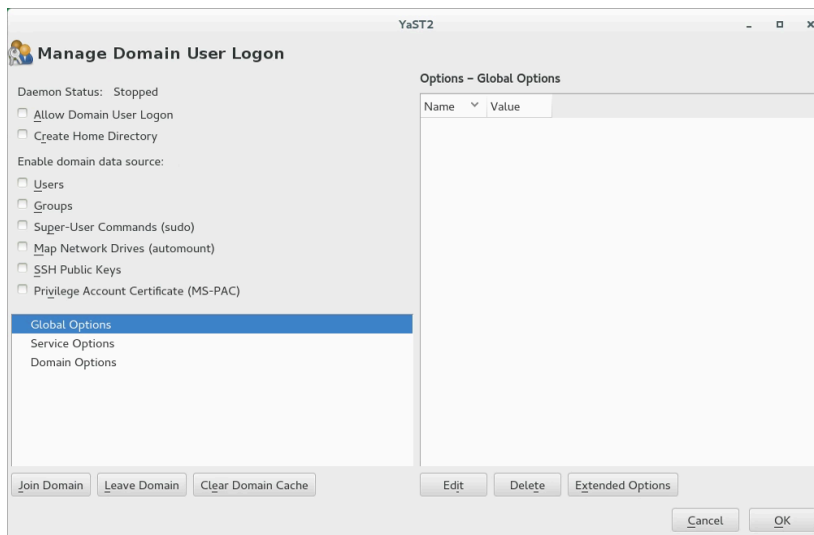

FIGURE 7.4: CONFIGURATION WINDOW OF USER LOGON MANAGEMENT

- a. To allow logging in to the computer using login data provided by Active Directory, activate *Allow Domain User Logon*.
- b. (Optional) Optionally, under *Enable domain data source*, activate additional data sources such as information on which users are allowed to use sudo or which network drives are available.
- c. To allow Active Directory users to have home directories, activate *Create Home Directories*. The path for home directories can be set in multiple ways—on the client, on the server, or both ways:
 - To configure the home directory paths on the Domain Controller, set an appropriate value for the attribute UnixHomeDirectory for each user. Additionally, make sure that this attribute replicated to the global catalog. For information on achieving that under Windows, see <https://support.microsoft.com/en-us/kb/248717>.
 - To configure home directory paths on the client in such a way that precedence is given to the path set on the domain controller, use the option fallback_home_dir.
 - To configure home directory paths on the client in such a way that the client setting overrides the server setting, use override_homedir.

As settings on the Domain Controller are outside of the scope of this documentation, only the configuration of the client-side options is described in the following.

From the side bar, select *Service Options* > *Name switch*, then click *Extended Options*. From that window, select either `fallback_homedir` or `override_homedir`, then click *Add*.

Specify a value. To have home directories follow the format `/home/USER_NAME`, use `/home/%u`. For more information about possible variables, see the man page `sssd.conf` (`man 5 sssd.conf`), section `override_homedir`.

Click *OK*.

7. Save the changes by clicking *OK*. Then make sure that the values displayed now are correct. To leave the dialog, click *Cancel*.

7.3.3 Joining Active Directory using *Windows domain membership*

To join an Active Directory domain using `winbind` and the *Windows Domain Membership* module of YaST, proceed as follows:

PROCEDURE 7.2: JOINING AN ACTIVE DIRECTORY DOMAIN USING *WINDOWS DOMAIN MEMBERSHIP*

1. Log in as `root` and start YaST.
2. Start *Network Services* > *Windows Domain Membership*.
3. Enter the domain to join at *Domain or Workgroup* in the *Windows Domain Membership* screen (see *Figure 7.5, "Determining Windows domain membership"*). If the DNS settings on your host are properly integrated with the Windows DNS server, enter the Active Directory domain name in its DNS format (`mydomain.mycompany.com`). If you enter the short name of your domain (also known as the pre–Windows 2000 domain name), YaST must rely on NetBIOS name resolution instead of DNS to find the correct domain controller.

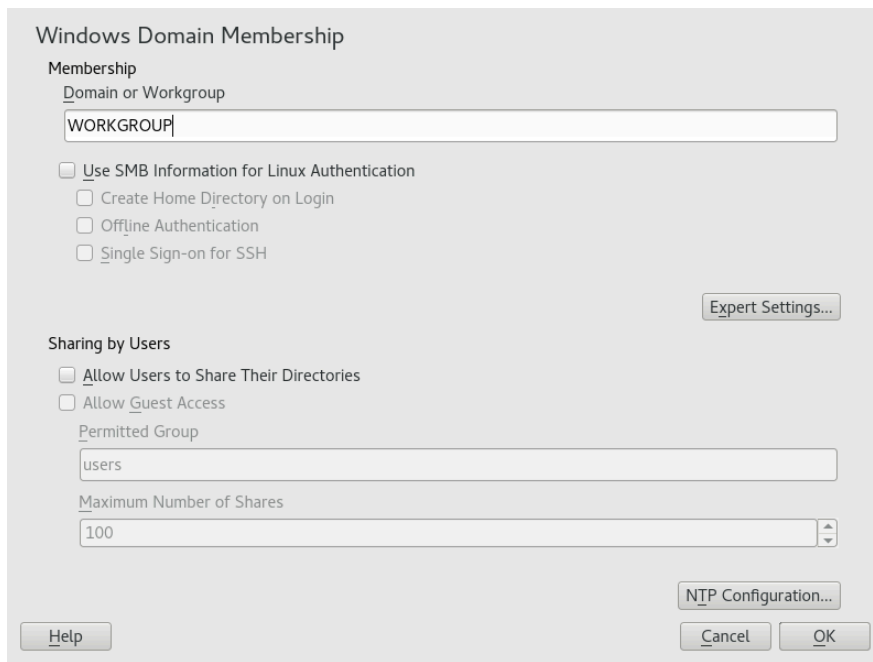

FIGURE 7.5: DETERMINING WINDOWS DOMAIN MEMBERSHIP

4. To use the SMB source for Linux authentication, activate *Also Use SMB Information for Linux Authentication*.
5. To automatically create a local home directory for Active Directory users on the Linux machine, activate *Create Home Directory on Login*.
6. Check *Offline Authentication* to allow your domain users to log in even if the Active Directory server is temporarily unavailable, or if you do not have a network connection.
7. To change the UID and GID ranges for the Samba users and groups, select *Expert Settings*. Let DHCP retrieve the WINS server only if you need it. This is the case when certain machines are resolved only by the WINS system.
8. Configure NTP time synchronization for your Active Directory environment by selecting *NTP Configuration* and entering an appropriate server name or IP address. This step is obsolete if you have already entered the appropriate settings in the stand-alone YaST NTP configuration module.
9. Click *OK* and confirm the domain join when prompted for it.
10. Provide the password for the Windows administrator on the Active Directory server and click *OK* (see [Figure 7.6, "Providing administrator credentials"](#)).

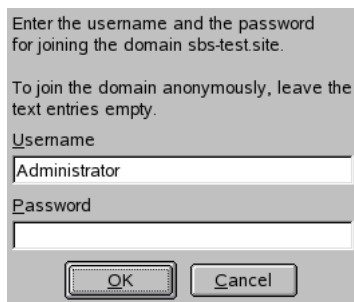

FIGURE 7.6: PROVIDING ADMINISTRATOR CREDENTIALS

After you have joined the Active Directory domain, you can log in to it from your workstation using the display manager of your desktop or the console.

! Important: Domain name

Joining a domain may not succeed if the domain name ends with `.local`. Names ending in `.local` cause conflicts with Multicast DNS (MDNS) where `.local` is reserved for link-local host names.

📝 Note: Only administrators can enroll a computer

Only a domain administrator account, such as `Administrator`, can join SUSE Linux Enterprise Server into Active Directory.

7.3.4 Checking Active Directory connection status

To check whether you are successfully enrolled in an Active Directory domain, use the following commands:

- `klist` shows whether the current user has a valid Kerberos ticket.
- `getent passwd` shows published LDAP data for all users.

7.4 Logging in to an Active Directory domain

Provided your machine has been configured to authenticate against Active Directory and you have a valid Windows user identity, you can log in to your machine using the Active Directory credentials. Login is supported for GNOME, the console, SSH and any other PAM-aware application.

Important: Offline authentication

SUSE Linux Enterprise Server supports offline authentication, allowing you to log in to your client machine even when it is offline. See [Section 7.2.3, “Offline service and policy support”](#) for details.

7.4.1 GDM

To authenticate a GNOME client machine against an Active Directory server, proceed as follows:

1. Click *Not listed*.
2. In the text box *Username*, enter the domain name and the Windows user name in this form:
DOMAIN_NAME\USER_NAME .
3. Enter your Windows password.

If configured to do so, SUSE Linux Enterprise Server creates a user home directory on the local machine on the first login of each user authenticated via Active Directory. This allows you to benefit from the Active Directory support of SUSE Linux Enterprise Server while still having a fully functional Linux machine at your disposal.

7.4.2 Console login

Besides logging in to the Active Directory client machine using a graphical front-end, you can log in using the text-based console or even remotely using SSH.

To log in to your Active Directory client from a console, enter DOMAIN_NAME\USER_NAME at the login: prompt and provide the password.

To remotely log in to your Active Directory client machine using SSH, proceed as follows:

1. At the login prompt, enter:

```
> ssh DOMAIN_NAME\USER_NAME@HOST_NAME
```

The `\` domain and login delimiter is escaped with another `\` sign.

2. Provide the user's password.

7.5 Changing passwords

SUSE Linux Enterprise Server helps the user choose a suitable new password that meets the corporate security policy. The underlying PAM module retrieves the current password policy settings from the domain controller and informs the user by a message on login about the specific password quality requirements a user account typically has. Like its Windows counterpart, SUSE Linux Enterprise Server presents a message describing:

- Password history settings
- Minimum password length requirements
- Minimum password age
- Password complexity

The password change process cannot succeed unless all requirements have been successfully met. Feedback about the password status is given both through the display managers and the console.

GDM provides feedback about password expiration and the prompt for new passwords in an interactive mode. To change passwords in the display managers, provide the password information when prompted.

To change your Windows password, you can use the standard Linux utility, `passwd`, instead of having to manipulate this data on the server. To change your Windows password, proceed as follows:

1. Log in at the console.
2. Enter `passwd`.

3. Enter your current password when prompted.
4. Enter the new password.
5. Reenter the new password for confirmation. If your new password does not comply with the policies on the Windows server, this feedback is given to you and you are prompted for another password.

To change your Windows password from the GNOME desktop, proceed as follows:

1. Click the *Computer* icon on the left edge of the panel.
2. Select *Control Center*.
3. From the *Personal* section, select *About Me* › *Change Password*.
4. Enter your old password.
5. Enter and confirm the new password.
6. Leave the dialog with *Close* to apply your settings.

7.6 Active Directory certificate auto-enrollment

Certificate auto-enrollment enables network devices to automatically enroll certificates from Active Directory Certificate Services, including SUSE Linux Enterprise Server devices, with no user intervention. This is managed by Active Directory's Group Policy, using Samba's `samba-gpupdate` command.

7.6.1 Configuring certificate auto-enrollment on the server

The Windows server roles Certification Authority, Certificate Enrollment Policy Web Service, Certificate Enrollment Web Service and Network Device Enrollment Service all must be installed and configured on the Active Directory server.

Configure Group Policy auto-enrollment as described in this Microsoft documentation: <https://docs.microsoft.com/en-us/windows-server/networking/core-network-guide/cncg/server-certs/configure-server-certificate-autoenrollment#configure-server-certificate-auto-enrollment>.

7.6.2 Enable certificate auto-enrollment on the client

Follow the steps in the following procedure to enable certificate on your clients.

1. Install the `samba-gpupdate` package. This automatically installs the `certmonger`, `cepces` and `sscep` dependencies. Samba uses `sscep` to download the Certificate Authority root chain, then uses the `certmonger` paired with `cepces` to monitor the host certificate templates.
2. Join to an Active Directory domain (one where the CA has been previously configured as explained in [Section 7.6.1, "Configuring certificate auto-enrollment on the server"](#)).
3. On Winbind-joined machines, set the `smb.conf` global parameter by adding the line `apply group policies = yes`.
4. For SSSD-joined machines, install `oddjob-gpupdate` from <https://github.com/openSUSE/oddjob-gpupdate>.
5. Then verify that certificate auto-enrollment is correctly configured by running the following command on the client:

```
> /usr/sbin/samba-gpupdate --rsop
```

If you see output like the following example, it is correctly configured:

```
Resultant Set of Policy
Computer Policy
GPO: Default Domain Policy
=====
CSE: gp_cert_auto_enroll_ext
-----
Policy Type: Auto Enrollment Policy
-----
[ <CA NAME> ] =
[ CA Certificate ] =
----BEGIN CERTIFICATE----
<CERTIFICATE>
----END CERTIFICATE----
[ Auto Enrollment Server ] = <DNS NAME>
```

6. Use the following command to display installed certificates:

```
> getcert list
Number of certificates and requests being tracked: 1.
Request ID 'Machine':
```

```
status: MONITORING
stuck: no
key pair storage: type=FILE,location='/var/lib/samba/private/certs/Machine.key'
certificate: type=FILE,location='/var/lib/samba/certs/Machine.crt'
CA: <CA NAME>
issuer: CN=<CA NAME>
subject: CN=<HOSTNAME>
expires: 2017-08-15 17:37:02 UTC
dns: <hostname>
key usage: digitalSignature,keyEncipherment
eku: id-kp-clientAuth,id-kp-serverAuth
certificate template/profile: Machine
```

Certificates are installed in [/var/lib/samba/certs](#) and private keys are installed in [/var/lib/samba/private/certs](#).

For more information, see [man samba-gpupdate](#).

8 Setting up a freeRADIUS server

The RADIUS (Remote Authentication Dial-In User Service) protocol has long been a standard service for manage network access. It provides authentication, authorization and accounting (AAA) for large businesses such as Internet service providers and cellular network providers, and is also popular for small networks. It authenticates users and devices, authorizes those users and devices for certain network services, and tracks use of services for billing and auditing. You do not have to use all three of the AAA protocols, but only the ones you need. For example, you may not need accounting but only client authentication, or perhaps all you want is accounting, and client authorization is managed by something else.

It is efficient and manages thousands of requests on modest hardware. It works for all network protocols and not just dial-up, but the name remains the same.

RADIUS operates in a distributed architecture, sitting separately from the Network Access Server (NAS). User access data is stored on a central RADIUS server that is available to multiple NAS. The NAS provides the physical access to the network, such as a managed Ethernet switch, or wireless access point.

FreeRADIUS is the open source RADIUS implementation, and is the most widely used RADIUS server. In this chapter you learn how to install and test a FreeRADIUS server. Because of the numerous use cases, after your initial setup is working correctly, your next stop is the official documentation, which is detailed and thorough (see <https://freeradius.org/documentation/> )

8.1 Installation and testing on SUSE Linux Enterprise Server

The following steps set up a simple test system. When you have verified that the server is operating correctly and you are ready to create a production configuration, you have several undo steps to perform before starting your production configuration.

First install the `freeradius-server` and `freeradius-server-utils` packages. Then enter `/etc/raddb/certs` and run the `bootstrap` script to create a set of test certificates:

```
# zypper in freeradius-server freeradius-server-utils
# cd /etc/raddb/certs
# ./bootstrap
```

The README in the `certs` directory contains a great deal of useful information. When the `bootstrap` script has completed, start the server in debugging mode:

```
# radiusd -X
[...]
Listening on auth address * port 1812 bound to server default
Listening on acct address * port 1813 bound to server default
Listening on auth address :: port 1812 bound to server default
Listening on acct address :: port 1813 bound to server default
Listening on auth address 127.0.0.1 port 18120 bound to server inner-tunnel
Listening on proxy address * port 54435
Listening on proxy address :: port 58415
Ready to process requests
```

When you see the `Listening` and `Ready to process requests` lines, your server has started correctly. If it does not start, read the output carefully because it tells you what went wrong. You may direct the output to a text file with `tee`:

```
> radiusd -X | tee radiusd.text
```

The next step is to test authentication with a test client and user. The client is a client of the RADIUS server, such as a wireless access point or switch. Clients are configured in `/etc/raddb/client.conf`. Human users are configured in `/etc/raddb/mods-config/files/authorize`.

Open `/etc/raddb/mods-config/files/authorize` and uncomment the following lines:

```
bob    Cleartext-Password := "hello"
Reply-Message := "Hello, %{User-Name}"
```

A test client, `client localhost`, is provided in `/etc/raddb/client.conf`, with a secret of `testing123`. Open a second terminal, and as an unprivileged user use the `radtest` command to log in as bob:

```
> radtest bob hello 127.0.0.1 0 testing123
Sent Access-Request Id 241 from 0.0.0.0:35234 to 127.0.0.1:1812 length 73
  User-Name = "bob"
  User-Password = "hello"
  NAS-IP-Address = 127.0.0.1
  NAS-Port = 0
  Message-Authenticator = 0x00
  Cleartext-Password = "hello"
Received Access-Accept Id 241 from 127.0.0.1:1812 to 0.0.0.0:0 length 20
```

In your `radius -X` terminal, a successful login looks like this:

```
(3) pap: Login attempt with password
```

```
(3) pap: Comparing with "known good" Cleartext-Password
(3) pap: User authenticated successfully
(3)      [pap] = ok
[...]
(3) Sent Access-Accept Id 241 from 127.0.0.1:1812 to 127.0.0.1:35234 length 0
(3) Finished request
Waking up in 4.9 seconds.
(3) Cleaning up request packet ID 241 with timestamp +889
```

Now run one more login test from a different computer on your network. Create a client configuration on your server by uncommenting and modifying the following entry in `clients.conf`, using the IP address of your test machine:

```
client private-network-1 }
  ipaddr      = 192.0.2.0/24
  secret      = testing123-1
  {
```

On the client machine, install `freeradius-server-utils`. Try logging in from the client as `bob`, using the `radtest` command. It is better to use the IP address of the RADIUS server rather than the hostname because it is faster:

```
> radtest bob hello 192.168.2.100 0 testing123-1
```

If your test logins fail, review all the output to learn what went wrong. There are several test users and test clients provided. The configuration files are full of useful information, and we recommend studying them. When you are satisfied with your testing and ready to create a production configuration, remove all the test certificates in `/etc/raddb/certs` and replace them with your own certificates, comment out all the test users and clients, and stop `radiusd` by pressing `Ctrl-C`. Manage the `radiusd.service` with `systemctl`, just like any other service. To learn how to fit a FreeRADIUS server in your network, see <https://freeradius.org/documentation/> and <https://networkradius.com/freeradius-documentation/> for in-depth references and howtos.

II Local security

- 9 Physical security **133**
- 10 Software management **143**
- 11 File management **149**
- 12 Encrypting partitions and files **156**
- 13 Storage encryption for hosted applications with cryptctl **163**
- 14 User management **176**
- 15 Restricting cron and at **195**
- 16 Spectre/Meltdown checker **198**
- 17 Configuring security settings with YaST **201**
- 18 The Polkit authentication framework **206**
- 19 Access control lists in Linux **214**
- 20 Intrusion detection with AIDE **226**

9 Physical security

Physical security is important. Linux production servers should be in locked data centers accessible to people that have passed security checks. Depending on the environment and circumstances, you can also consider boot loader passwords.

Additionally, consider questions like:

- Who has direct physical access to the host?
- Of those that do, should they?
- Can the host be protected from tampering and should it be?

The amount of physical security needed on a particular system depends on the situation, and can also vary widely depending on available funds.

9.1 System locks

Most server racks in data centers include a locking feature. This is a hasp/cylinder lock on the front of the rack that allows you to turn an included key to a locked or unlocked position—granting or denying entry. Cage locks can help prevent someone from tampering or stealing devices/media from the servers, or opening the cases and directly manipulating/sabotaging the hardware. Preventing system reboots or the booting from alternate devices is also important (for example CD, DVDs, flash disks, etc.).

Some servers also have case locks. These locks can do different things according to the designs of the system vendor and construction. Many systems are designed to self-disable if attempts are made to open the system without unlocking. Others have device covers that do not let you plug in or unplug keyboards or mice. While locks are sometimes a useful feature, they are lower quality and easily defeated by attackers with ill intent.

9.2 Locking down the BIOS



Tip: Secure boot

This section describes basic methods to secure the boot process. To find out about more advanced boot protection using UEFI and the secure boot feature, see *Book “Administration Guide”, Chapter 17 “UEFI (Unified Extensible Firmware Interface)”, Section 17.1 “Secure boot”*.

The BIOS (Basic Input/Output System) or its successor UEFI (Unified Extensible Firmware Interface) is the lowest level of software/firmware on PC class systems. Other hardware types (POWER, IBM Z) that run Linux have low-level firmware that performs similar functions as the PC BIOS. When this document references the BIOS, it means BIOS and/or UEFI. The BIOS dictates system configuration, puts the system into a well defined state and provides routines for accessing low-level hardware. The BIOS executes the configured Linux boot loader (like GRUB 2) to boot the host.

Most BIOS implementations can be configured to prevent unauthorized users from manipulating system and boot settings. This is typically done by setting a BIOS administrator or boot password. The administrator password needs to be entered for changing the system configuration but the boot password is required during every normal boot. For most use cases, it is enough to set an administrator password and restrict booting to the built-in hard disk. This way an attacker is not able to simply boot a Linux live CD or flash drive, for example. Although this does not provide a high level of security (a BIOS can be reset, removed or modified—assuming case access), it can be another deterrent.

Many BIOS firmware implementations have other security-related settings. Check with the system vendor, the system documentation, or examine the BIOS during a system boot to find out more.



Important: Booting when a BIOS boot password is set

If a system has been set up with a boot password, the host does not boot up unattended (for example, in case of a system reboot or power failure). This is a trade-off.

Important: Losing the BIOS administrator password

Once a system is set up for the first time, the BIOS administrator password is not required often. Do not forget the password or you may need to clear the BIOS memory via hardware manipulation to get access again.

9.3 Security via the boot loaders

The Linux boot loader GRUB 2, which is used by default in SUSE Linux Enterprise Server can have a boot password set. It also provides a password feature, so that only administrators can start the interactive operations (for example editing menu entries and entering the command line interface). If a password is specified, GRUB 2 disallows any interactive control until you press the key **C** and **E** and enter a correct password.

You can refer to the GRUB 2 man page for examples.

It is important to keep in mind that when setting these passwords they need to be remembered. Also, enabling these passwords can merely slow an intrusion, not necessarily prevent it. Again, someone could boot from a removable device, and mount your root partition. If you are using BIOS-level security and a boot loader, it is a good practice to disable the ability to boot from removable devices in your computer's BIOS, and then password-protect the BIOS itself.

Also keep in mind that the boot loader configuration files need to be protected by changing their mode to `600` (read/write for `root` only), or others can read your passwords or hashes.

9.4 Retiring Linux servers with sensitive data

Security policies contain certain procedures for the treatment of storage media that is going to be retired or disposed of. Disk and media wipe procedures are frequently prescribed, as is complete destruction of the media. You can find several free tools on the Internet. A search for “dod disk wipe utility” yields several variants. To retire servers with sensitive data, it is important to ensure that data cannot be recovered from the hard disks. To ensure that all traces of data are removed, a wipe utility—such as `scrub`—can be used. Many wipe utilities overwrite the data several times. This assures that even sophisticated methods are not able to retrieve any parts of the wiped data. Some tools can even be operated from a bootable removable device and

remove data according to the U.S. Department of Defense (DoD) standards. Many government agencies specify their own standards for data security. Some standards are stronger than others, yet may require more time to implement.



Important: Wiping wear leveling devices

Some devices, like SSDs, use wear leveling and do not necessarily write new data in the same physical locations. Such devices provide their own erasing functionality.

9.4.1 scrub: disk overwrite utility

scrub overwrites hard disks, files and other devices with repeating patterns intended to make recovering data from these devices more difficult. It operates in three basic modes: on a character or block device, on a file, or on a specified directory. For more information, see the manual page `man 1 scrub`.

SUPPORTED SCRUB METHODS

nnsa

4-pass NNSA Policy Letter NAP-14.1-C (XVI-8) for sanitizing removable and non-removable hard disks, which requires overwriting all locations with a pseudo-random pattern twice and then with a known pattern: random (x2), 0x00, verify.

dod

4-pass DoD 5220.22-M section 8-306 procedure (d) for sanitizing removable and non-removable rigid disks. This requires overwriting all addressable locations with a character, its complement, a random character and then verifying. Note: scrub performs the random pass first to make verification easier: random, 0x00, 0xff, verify.

bsi

9-pass method recommended by the German Center of Security in Information Technologies (<https://www.bsi.bund.de>): 0xff, 0xfe, 0xfd, 0xfb, 0xf7, 0xef, 0xdf, 0xbf, 0x7f.

gutmann

The canonical 35-pass sequence described in Gutmann's paper cited below.

schneier

7-pass method described by Bruce Schneier in "Applied Cryptography" (1996): 0x00, 0xff, random (x5)

pfitzner7

Roy Pfitzner's 7-random-pass method: random (x7).

pfitzner33

Roy Pfitzner's 33-random-pass method: random (x33).

usarmy

US Army AR380-19 method: 0x00, 0xff, random. (Note: identical to DoD 522.22-M section 8-306 procedure (e) for sanitizing magnetic core memory).

fillzero

1-pass pattern: 0x00.

fillff

1-pass pattern: 0xff.

random

1-pass pattern: random (x1).

random2

2-pass pattern: random (x2).

old

6-pass pre-version 1.7 scrub method: 0x00, 0xff, 0xaa, 0x00, 0x55, verify.

fastold

5-pass pattern: 0x00, 0xff, 0xaa, 0x55 and verify.

custom=string

1-pass custom pattern. String may contain C-style numerical escapes: \nnn (octal) or \xnn (hex).

9.5 Restricting access to removable media

In certain environments, it is required to restrict access to removable media such as USB storage or optical devices. The tools included with the `udisks2` package help with such a configuration.

1. Create a user group whose users are allowed to mount and eject removable devices, for example `mmedia_all`:

```
> sudo groupadd mmedia_all
```

2. Add a specific user `tux` to the new group:

```
> sudo usermod -a -G mmedia_all tux
```

3. Create the `/etc/polkit-1/rules.d/10-mount.rules` file with the following content:

```
> cat /etc/polkit-1/rules.d/10-mount.rules
polkit.addRule(function(action, subject) {
  if (action.id == "org.freedesktop.udisks2.eject-media"
    && subject.isInGroup("mmedia_all")) {
    return polkit.Result.YES;
  }
});

polkit.addRule(function(action, subject) {
  if (action.id == "org.freedesktop.udisks2.filesystem-mount"
    && subject.isInGroup("mmedia_all")) {
    return polkit.Result.YES;
  }
});
```



Important: Naming of the rules file

The name of a rules file must start with a digit, otherwise it is ignored.

Rules files are processed in alphabetical order. Functions are called in the order they were added until one of the functions returns a value. Therefore, to add an authorization rule that is processed before other rules, put it in a file in `/etc/polkit-1/rules.d` with a name that sorts before other rules files, for example `/etc/polkit-1/rules.d/10-mount.rules`. Each function should return a value from `polkit.Result`.

4. Restart `udisks2`:

```
# systemctl restart udisks2
```

5. Restart `polkit`

```
# systemctl restart polkit
```

9.6 System protection with enforced USB device authorization via *USBGuard*

The USBGuard software framework helps to protect your system with enforced USB device authorization. It implements allowlist and blocklist capabilities based on the device attributes.

The USBGuard provides the following features:

- A command-line interface to interact with a running USBGuard daemon
- The daemon component with an inter-process communication (IPC) interface for dynamic interaction and policy enforcement
- The rule language for writing USB device authorization policies
- The C++ API for interacting with the daemon component implemented in a shared library

9.6.1 Installing USBGuard

The USBGuard daemon decides which USB device to authorize based on a set of rules defined in the policy. To install and configure USBGuard, use the following commands:

1. To install USBGuard:

```
> sudo zypper install usbguard
```

USBGuard and the required dependencies are installed. If you want to interact with the USBGuard service, you can install `usbguard-tools`.

2. To generate a rule set based on currently connected USB devices, switch to `root`:

```
# usbguard generate-policy > /etc/usbguard/rules.conf
```



Note

You can customize USBGuard by editing the `/etc/usbguard/rules.conf` file.

3. You can start the USBGuard daemon or ensure automatic enablement at system start by switching to `root`:

```
# systemctl enable --now usbguard.service
```

4. You can either authorize or deauthorize a device from interacting with the system. This depends on the value of the `ImplicitPolicyTarget` option in the `usbguard-daemon.conf` file. This option is used to treat devices that do not match any rule in the policy.

```
usbguard allow-device 6
```

```
usbguard block-device 6
```

You can also use the `reject-device` option to deauthorize and remove a device from the system.



Note

Use the `usbguard --help` command to see all the options.

9.6.2 How to use USBGuard

You can configure a security policy to protect your system with enforced USB device authorization by implementing *allow* and *block* lists based on the device attributes.

9.6.2.1 The USBGuard configuration file

The USBGuard daemon loads the `usbguard-daemon.conf` file after the command-line options are parsed and are used to configure the runtime parameters of the daemon. The file is, by default, located at `/etc/usbguard/usbguard-daemon.conf`. Some options in the file include:

OPTIONS

RuleFile=PATH

The USBGuard daemon uses this file to load the policy rule set from it and to write new rules received through the IPC (inter-process communication) interface. The default is `%sysconfdir%/usbguard/rules.conf`.

ImplicitPolicyTarget= TARGET

How to treat devices that do not match any rule in the policy, for example:

- allow - authorize every present device
- block - deauthorize every present device
- reject - logically remove the device node from the system

PresentDevicePolicy= POLICY

How to treat devices that are already connected when the daemon starts.

- allow - authorize every present device
- block - deauthorize every present device
- reject - remove every present device
- keep - sync the internal state
- apply-policy - evaluate the rule set for all present devices

IPCAllowedUsers= USERNAME

A space-delimited list of user names that the daemon accepts IPC connections from.

IPCAllowedGroups= GROUPNAME

A space-delimited list of group names that the daemon accepts IPC connections from.

IPCAccessControlFiles= PATH

Path to files that are interpreted by the daemon as IPC access control definition files.

EXAMPLE 9.1: CONFIGURATION

```
IPCAllowedUsers=root joe
IPCAllowedGroups=wheel
```

The example allows full IPC access to the users root, joe and to the members of the group wheel.

9.6.3 More information

To know more about USBGuard, see:

- The upstream documentation at <https://usbguard.github.io/> 
- man *usbguard*

- `man usbguard-rules.conf`
- `man usbguard-daemon`
- `man usbguard-daemon.conf`

10 Software management

10.1 Removing unnecessary software packages (RPMs)

An important step in securing a Linux system is to determine the primary functions or roles of the Linux server. Otherwise, it can be difficult to understand what needs to be secured and securing these Linux systems can prove ineffective. Therefore, it is critical to look at the default list of software packages and remove any unnecessary packages or packages that do not comply with your defined security policies.

Generally, an RPM software package consists of the following:

- The package's metadata that is written to the RPM database upon installation.
- The package's files and directories.
- Scripts that are being executed before and after installation and removal.

Packages generally do not impose any security risk to the system *unless* they contain:

1. setuid or setgid bits on any of the installed files
2. group- or world-writable files or directories
3. a service that is activated upon installation, or by default

Assuming that none of the three conditions above apply, a package is merely a collection of files. Neither installation nor uninstallation of such packages has any influence on the security value of the system.

Nevertheless, it is useful to restrict the installed packages in your system to a minimum. Doing this results in fewer packages that require updates and simplifies maintenance efforts when security alerts and patches are released. It is a best practice not to install, among others, development packages or desktop software packages (for example, an X Server) on production servers. If you do not need them, you should also not install, for example, the Apache Web server or Samba file sharing server.

Important: Requirements of third-party installers

Many third-party vendors like Oracle and IBM require a desktop environment and development libraries to run installers. To prevent this from having an impact on the security of their production servers, many organizations work around this by creating a silent installation (response file) in a development lab.

Also, other packages like FTP and Telnet daemons should not be installed unless there is a justified business reason for it. `ssh`, `scp` or `sftp` should be used as replacements.

One of the first action items should be to create a Linux image that *only* contains RPMs needed by the system and applications, and those needed for maintenance and troubleshooting purposes. A good approach is to start with a minimum list of RPMs and then add packages as needed.

Tip: SLES Minimal VM

The SUSE Linux Enterprise Server download page offers preconfigured and ready-to-run SLES Minimal VM virtual machine images. SLES Minimal VM has a small footprint and can be customized to fit specific needs of a system developer. SLES Minimal VM is designed for use in virtual machines and for virtual software appliance development. The key benefits of SLES Minimal VM are efficiency and simplified management. More information about SLES Minimal VM is available in the dedicated guide. If SLES Minimal VM does not meet your requirements, consider the minimal installation pattern.

To generate a list of all installed packages, use the following command:

```
# zypper packages -i
```

To retrieve details about a particular package, run:

```
# zypper info PACKAGE_NAME
```

To check for and report potential conflicts and dependencies when deleting a package, run:

```
# zypper rm -D PACKAGE_NAME
```

This can be useful, as running the removal command without a test can often yield a lot of complaints and require manual recursive dependency hunting.

! Important: Removal of essential system packages

When removing packages, be careful not to remove any essential system packages. This could put your system into a broken state in which it can no longer be booted or repaired. If you are uncertain about this, then it is best to do a complete backup of your system before you start to remove any packages.

For the final removal of one or more packages use the following `zypper` command with the added “-u” switch, which removes any unused dependencies:

```
# zypper rm -u PACKAGE_NAME
```

10.2 Patching Linux systems

Building an infrastructure for patch management is another important part of a proactive and secure Linux production environment.

It is recommended to have a written security policy and procedure to handle Linux security updates and issues. For example, a security policy should detail the time frame for assessment, testing and roll out of patches. Network related security vulnerabilities should get the highest priority and should be addressed immediately within a short time frame. The assessment phase should occur within a testing lab, and initial rollout should occur on development systems first. A separate security log file should contain details on which Linux security announcements have been received, which patches have been researched and assessed, when patches were applied, and so on.

SUSE releases patches in three categories: security, recommended and optional. There are a few options that can be used to keep systems patched, up to date, and secure. Each system can register and then retrieve updates via the SUSE Update Web site using the included YaST tool—YaST Online Update. SUSE has also created the Repository Mirroring Tool (RMT), an efficient way to maintain a local repository of available/released patches/updates/fixes that systems can then pull from (reducing Internet traffic). SUSE also offers SUSE Manager for the maintenance, patching, reporting and centralized management of Linux systems, not only SUSE, but other distributions as well.

10.2.1 YaST Online Update

On a per-server basis, installation of important updates and improvements is possible using the YaST Online Update tool. Current updates for SUSE Linux Enterprise Server are available from the product specific update catalogs containing patches. Installation of updates and improvements is accomplished using YaST and selecting *Online Update* in the *Software* group. All new patches (except the optional ones) that are currently available for your system are marked for installation. Clicking *Accept* automatically installs these patches.

10.2.2 Automatic Online Update

YaST also offers the possibility to set up an automatic update. Select *Software* > *Automatic Online Update*. Configure a Daily or a Weekly update. Some patches, such as kernel updates, require user interaction, which would cause the automatic update procedure to stop. Check *Skip Interactive Patches* for the update procedure to proceed automatically.

In this case, run a manual Online Update from time to time to install patches that require interaction. When *Only Download Patches* is checked, the patches are downloaded at the specified time but not installed. They must be installed manually using `rpm` or `zypper`.

10.2.3 Repository Mirroring Tool—RMT

The Repository Mirroring Tool for SUSE Linux Enterprise goes one step further than the Online Update process by establishing a proxy system with repository and registration targets. This helps customers centrally manage software updates within the firewall on a per-system basis, while maintaining their corporate security policies and regulatory compliance.

The RMT (<https://documentation.suse.com/sles/15-SP4/html/SLES-all/book-rmt.html>) is integrated with SUSE Customer Center (<https://scc.suse.com/>) and provides a repository and registration target that is synchronized with it. This can be helpful in tracking entitlements in large deployments. The RMT maintains all the capabilities of SUSE Customer Center, while allowing a more secure centralized deployment. It is included with every SUSE Linux Enterprise subscription and is therefore fully supported.

The RMT provides an alternative to the default configuration, which requires opening the firewall to outbound connections for each device to receive updates. That requirement often violates corporate security policies and can be seen as a threat to regulatory compliance by certain

organizations. Through its integration with SUSE Customer Center, the RMT ensures that each device can receive its appropriate updates without the need to open the firewall, and without any redundant bandwidth requirements.

The RMT also enables customers to locally track their SUSE Linux Enterprise devices (that is, servers, desktops or Point of Service terminals) throughout their enterprise. Now they can easily determine how many entitlements are in need of renewal at the end of a billing cycle without having to physically walk through the data center to manually update spreadsheets.

The RMT informs the SUSE Linux Enterprise devices of any available software updates. Each device then obtains the required software updates from the RMT. The introduction of the RMT improves the interaction among SUSE Linux Enterprise devices within the network and simplifies how they receive their system updates. The RMT enables an infrastructure for several hundred SUSE Linux Enterprise devices per instance of each installation (depending on the specific usage profile). This offers more accurate and efficient server tracking.

In a nutshell, the Repository Mirroring Tool for SUSE Linux Enterprise provides customers with:

- Assurance of firewall and regulatory compliance
- Reduced bandwidth usage during software updates
- Full support under active subscription from SUSE
- Maintenance of existing customer interface with SUSE Customer Center
- Accurate server entitlement tracking and effective measurement of subscription usage
- Automated process to easily tally entitlement totals (no more spreadsheets!)
- Simple installation process that automatically synchronizes server entitlement with SUSE Customer Center

10.2.4 SUSE Manager

SUSE Manager automates Linux server management, allowing you to provision and maintain your servers faster and more accurately. It monitors the health of each Linux server from a single console so you can identify server performance issues before they impact your business.

And it lets you comprehensively manage your Linux servers across physical, virtual and cloud environments while improving data center efficiency. SUSE Manager delivers complete lifecycle management for Linux:

- Asset management
- Provisioning
- Package management
- Patch management
- Configuration management
- Redeployment

For more information on SUSE Manager, refer to <https://www.suse.com/products/suse-manager/>.

11 File management

11.1 Disk partitions

Servers should have separate file systems for at least `/`, `/boot`, `/var`, `/tmp`, and `/home`. This prevents, for example, logging space and temporary space under `/var` and `/tmp` from filling up the root partition. Third-party applications should be on separate file systems as well, for example under `/opt`.

Another advantage of separate file systems is the possibility of choosing special mount options that are suitable for certain regions in the file system hierarchy. The mount options are:

- `noexec`: prevents execution of files.
- `nodev`: prevents character or block special devices from being usable.
- `nosuid`: prevents the `set-user-ID` or `set-group-ID` bits from being effective.
- `ro`: mounts the file system `read-only`.

Each of these options needs to be carefully considered before applying it to a partition mount. Applications may stop working, or the support status may be violated. When applied correctly, mount options can help against certain types of security attacks or misconfigurations. For example, there should be no need for `set-user-ID` binaries to be placed in `/tmp`.

You are advised to review [Chapter 27, Common Criteria](#). It is important to understand the need to separate the partitions that could impact a running system (for example, log files filling up `/var/log` are a good reason to separate `/var` from the `/` partition). Another thing to keep in mind is that you need to use LVM or another volume manager or at the least the extended partition type to work around the limit of four primary partitions on PC class systems.

Another capability in SUSE Linux Enterprise Server is encrypting a partition or even a single directory or file as a container. Refer to [Chapter 12, Encrypting partitions and files](#) for details.

11.2 Modifying permissions of certain system files

Many files—especially in the `/etc` directory—are world-readable, which means that unprivileged users can read their contents. Normally this is not a problem, but to take extra care, you can remove the world-readable or group-readable bits for sensitive files.

SUSE Linux Enterprise Server provides the `permissions` package to easily apply file permissions. The package comes with three pre-defined system profiles:

easy

Profile for systems that require user-friendly graphical user interaction. This is the default profile.

secure

Profile for server systems without fully fledged graphical user interfaces.

paranoid

Profile for maximum security. In addition to the `secure` profile, it removes *all* special permissions like `setuid/setgid` and capability bits.



Warning: Unusable system for non-privileged users

Except for simple tasks like changing passwords, a system without special permissions may be unusable for non-privileged users.

Do not use the `paranoid` profile as-is, but as a template for custom permissions. More information can be found in the `permissions.paranoid` file.

To define custom file permissions, edit `/etc/permissions.local` or create a drop-in file in the `/etc/permissions.d/` directory.

```
# Additional custom hardening
/etc/security/access.conf    root:root    0400
/etc/sysctl.conf            root:root    0400
/root/                      root:root    0700
```

The first column specifies the file name. The directory names must end with a slash. The second column specifies the owner and group, and the third column specifies the mode. For more information about the configuration file format, refer to `man permissions`.

Select the profile in `/etc/sysconfig/security`. To use the `easy` profile and custom permissions from `/etc/permissions.local`, set:

```
PERMISSION_SECURITY="easy local"
```

To apply the setting, run `chkstat --system --set`.

The permissions are also applied during package updates via `zypper`. You could also call `chkstat` regularly via `cron` or a `systemd` timer.

! Important: Custom file permissions

While the system profiles are well tested, custom permissions can break standard applications. SUSE cannot provide support for such scenarios.

Always test custom file permissions before applying them with `chkstat` to make sure everything works as desired.

11.3 Changing home directory permissions from 755 to 700

By default, home directories of users are accessible (read, execute) by all users on the system. As this is a potential information leak, home directories should be accessible by their owners.

The following commands set the permissions to `700` (directory accessible for the owner) for all existing home directories in `/home`:

```
> sudo chmod 755 /home
> sudo bash -c 'for dir in /home/*; do \
echo "Changing permissions of directory $dir"; chmod 700 "$dir"; done'
```

To ensure newly created home directories are created with secure permissions, edit `/etc/login.defs` and set `HOME_MODE` to `700`.

```
# HOME_MODE is used by useradd(8) and newusers(8) to set the mode for new
# home directories.
# If HOME_MODE is not set, the value of UMASK is used to create the mode.
HOME_MODE      0700
```

If you do not set `HOME_MODE`, permissions are calculated from the default `umask`. `HOME_MODE` specifies the permissions used, not a mask used to remove access like `umask`. For more information about `umask`, refer to [Section 11.4, "Default umask"](#).

You can verify the configuration change by creating a new user with `useradd -m testuser`. Check the permissions of the directories with `ls -l /home`. Afterwards, remove the user created for this test.

! Important: Test permission changes

Users are no longer allowed to access other users' home directories. This may be unexpected for users and software.

Test this change before using it in production and notify users affected by the change.

11.4 Default umask

The **umask** (user file-creation mode mask) command is a shell built-in command that determines the default file permissions for newly created files and directories. This can be overwritten by system calls but many programs and utilities use **umask**.

By default, **umask** is set to `022`. This umask is subtracted from the access mode `777` if at least one bit is set.

To determine the active umask, use the **umask** command:

```
> umask
022
```

With the default umask, you see the behavior most users expect to see on a Linux system.

```
> touch a
> mkdir b
> ls -on
total 16
-rw-r--r--. 1 17086    0 Nov 29 15:05 a
drwxr-xr-x. 2 17086 4096 Nov 29 15:05 b
```

You can specify arbitrary umask values, depending on your needs.

```
> umask 111
> touch c
> mkdir d
> ls -on
total 16
-rw-rw-rw-. 1 17086    0 Nov 29 15:05 c
drw-rw-rw-. 2 17086 4096 Nov 29 15:05 d
```

Based on your threat model, you can use a stricter umask such as `037` to prevent accidental data leakage.

```
> umask 037
> touch e
> mkdir f
> ls -on
total 16
-rw-r-----. 1 17086    0 Nov 29 15:06 e
drwxr-----. 2 17086 4096 Nov 29 15:06 f
```



Tip: Maximum security

For maximum security, use a umask of `077`. This forces newly created files and directories to be created with no permissions for the group and other users.

This can be unexpected for users and software and may cause additional load for your support team.

11.4.1 Adjusting the default umask

You can modify the umask globally for all users by changing the `UMASK` value in `/etc/login.defs`.

```
# Default initial "umask" value used by login(1) on non-PAM enabled systems.
# Default "umask" value for pam_umask(8) on PAM enabled systems.
# UMASK is also used by useradd(8) and newusers(8) to set the mode for new
# home directories.
# 022 is the default value, but 027, or even 077, could be considered
# for increased privacy. There is no One True Answer here: each sysadmin
# must make up their mind.
UMASK          022
```

For individual users, add the umask to the 'gecos' field in `/etc/passwd` like this:

```
tux:x:1000:100:Tux Linux,UMASK=022:/home/tux:/bin/bash
```

You can do the same with `yast users` by adding `UMASK=022` to a user's *Details > Additional User Information*.

The settings made in `/etc/login.defs` and `/etc/passwd` are applied by the PAM module `pam_umask.so`. For additional configuration options, refer to `man pam_umask`.

For the changes to take effect, users need to log out and back in again. Afterwards, use the `umask` command to verify the umask is set correctly.

11.5 SUID/SGID files

When the SUID (set user ID) or SGID (set group ID) bits are set on an executable, it executes with the UID or GID of the owner of the executable rather than that of the person executing it. This means that, for example, all executables that have the SUID bit set and are owned by `root` are executed with the UID of `root`. A good example is the `passwd` command that allows ordinary users to update the password field in the `/etc/shadow` file, which is owned by `root`.

SUID/SGID bits can be misused when the executable has a security hole. Therefore, you should search the entire system for SUID/SGID executables and document them. To search the entire system for SUID or SGID files, you can run the following command:

```
# find /bin /boot /etc /home /lib /lib64 /opt /root /sbin \  
/srv /tmp /usr /var -type f -perm '/6000' -ls
```

You may need to extend the list of directories that are searched if you have a different file system structure.

SUSE sets the SUID/SGID bit on binary if it is really necessary. Ensure that code developers do not set SUID/SGID bits on their programs if it is not an absolute requirement. You can often use workarounds like removing the executable bit for world/others. However, a better approach is to change the design of the software or use capabilities.

SUSE Linux Enterprise Server supports file capabilities to allow more fine-grained privileges to be given to programs rather than the full power of root:

```
# getcap -v /usr/bin/ping  
/usr/bin/ping = cap_new_raw+eip
```

The previous command grants the CAP_NET_RAW capability to whoever executes ping. In case of vulnerabilities inside ping, an attacker can gain, at most, this capability in contrast with full root. Whenever possible, file capabilities should be chosen in favor of the SUID bit. But this applies when the binary is SUID to root, not to other users such as news, lp and similar.

11.6 World-writable files

World-writable files are a security risk since they can be modified by any user on the system. Additionally, world-writable directories allow anyone to add or delete files. To locate world-writable files and directories, you can use the following command:

```
# find /bin /boot /etc /home /lib /lib64 /opt /root /sbin \  
/srv /tmp /usr /var -type f -perm -2 ! -type l -ls
```

You may need to extend the list of directories that are searched if you have a different file system structure.

The ! -type l parameter skips all symbolic links since symbolic links are always world-writable. However, this is not a problem if the target of the link is not world-writable, which is checked by the above find command.

World-writable directories with the sticky bit such as the `/tmp` directory do not allow anyone except the owner of a file to delete or rename it in this directory. The sticky bit makes files stick to the user who created them, and prevents other users from deleting or renaming the files. Therefore, depending on the purpose of the directory, world-writable directories with the sticky bit are not an issue. An example is the `/tmp` directory:

```
> ls -ld /tmp
drwxrwxrwt 18 root root 16384 Dec 23 22:20 /tmp
```

The `t` mode bit in the output denotes the sticky bit.

11.7 Orphaned or unowned files

Files not owned by any user or group may not necessarily be a security problem in itself. However, unowned files could pose a security problem in the future. For example, if a new user is created and the new user happens to get the same UID as the unowned files have, then this new user automatically becomes the owner of these files.

To locate files not owned by any user or group, use the following command:

```
# find /bin /boot /etc /home /lib /lib64 /opt /root /sbin /srv /tmp /usr /var -nouser -o -nogroup
```

You may need to extend the list of directories that are searched if you have a different file system structure.

A different problem is files that were not installed via the packaging system and therefore do not receive updates. You can check for such files with the following command:

```
> find /bin /lib /lib64 /usr -path /usr/local -prune -o -type f -a -exec /bin/sh -c "rpm -qf {} &> /dev/null || echo {}" \;
```

Run this command as an untrusted user (for example, `nobody`) since crafted file names may lead to command execution. This should not be a problem since these directories should be writable by `root`, but it is still a good security precaution.

This shows you all files under `/bin`, `/lib`, `/lib64` and `/usr` (with the exception of files in `/usr/local`) that are not tracked by the package manager. These files may not represent a security issue, but you should be aware of what is not tracked and take the necessary precautions to keep these files up to date.

12 Encrypting partitions and files

Encrypting files, partitions, and entire disks prevents unauthorized access to your data and protects your confidential files and documents.

You can choose between the following encryption options:

Encrypting a hard disk partition

It is possible to create an encrypted partition with YaST during installation or in an already installed system. For further info, see [Section 12.1.1, “Creating an encrypted partition during installation”](#) and [Section 12.1.2, “Creating an encrypted partition on a running system”](#). This option can also be used for removable media, such as external hard disks, as described in [Section 12.1.3, “Encrypting the content of removable media”](#).

Encrypting single files with GPG

To quickly encrypt one or more files, you can use the GPG tool. See [Section 12.2, “Encrypting files with GPG”](#) for more information.

Encrypting single files with Rage

You can use the Rage encryption tool to encrypt one or more files. See [Section 12.3, “Encrypting files with Rage”](#) for more information.



Warning: Encryption offers limited protection

Encryption methods described in this chapter cannot protect your running system from being compromised. After the encrypted volume is successfully mounted, everybody with appropriate permissions can access it. However, encrypted media are useful in case of loss or theft of your computer, or to prevent unauthorized individuals from reading your confidential data.

12.1 Setting up an encrypted file system with YaST

Use YaST to encrypt partitions or parts of your file system during installation or in an already installed system. However, encrypting a partition in an already-installed system is more difficult, because you need to resize and change existing partitions. In such cases, it may be more convenient to create an encrypted file of a defined size, in which to *store* other files or parts

of your file system. To encrypt an entire partition, dedicate a partition for encryption in the partition layout. The standard partitioning proposal, as suggested by YaST, does not include an encrypted partition by default. Add an encrypted partition manually in the partitioning dialog.

12.1.1 Creating an encrypted partition during installation



Warning: Password input

Make sure to memorize the password for your encrypted partitions well. Without that password, you cannot access or restore the encrypted data.

The YaST expert dialog for partitioning offers the options needed for creating an encrypted partition. To create a new encrypted partition proceed as follows:

1. Run the YaST Expert Partitioner with *System > Partitioner*.
2. Select a hard disk, click *Add*, and select a primary or an extended partition.
3. Select the partition size or the region to use on the disk.
4. Select the file system, and mount point of this partition.
5. Activate the *Encrypt device* check box.



Note: Additional software required

After checking *Encrypt device*, a pop-up window asking for installing additional software may appear. Confirm to install all the required packages to ensure that the encrypted partition works well.

6. If the encrypted file system needs to be mounted when necessary, enable *Do not mount partition* in the *Fstab Options*. Otherwise enable *Mount partition* and enter the mount point.
7. Click *Next* and enter a password which is used to encrypt this partition. This password is not displayed. To prevent typing errors, you need to enter the password twice.
8. Complete the process by clicking *Finish*. The newly encrypted partition is now created.

During the boot process, the operating system asks for the password before mounting any encrypted partition which is set to be auto-mounted in `/etc/fstab`. Such a partition is then available to all users when it has been mounted.

To skip mounting the encrypted partition during start-up, press **Enter** when prompted for the password. Then decline the offer to enter the password again. In this case, the encrypted file system is not mounted and the operating system continues booting, blocking access to your data. To mount an encrypted partition which is not mounted during the boot process, open a file manager and click the partition entry in the pane listing common places on your file system. You are prompted for a password and the partition is mounted.

When you are installing your system on a machine where partitions already exist, you can also decide to encrypt an existing partition during installation. In this case follow the description in [Section 12.1.2, "Creating an encrypted partition on a running system"](#) and be aware that this action destroys all data on the existing partition.

12.1.2 Creating an encrypted partition on a running system



Warning: Activating encryption on a running system

It is also possible to create encrypted partitions on a running system. However, encrypting an existing partition destroys all data on it, and requires re-sizing and restructuring of existing partitions.

On a running system, select *System* > *Partitioner* in the YaST control center. Click *Yes* to proceed. In the *Expert Partitioner*, select the partition to encrypt and click *Edit*. The rest of the procedure is the same as described in [Section 12.1.1, "Creating an encrypted partition during installation"](#).

12.1.3 Encrypting the content of removable media

YaST treats removable media (like external hard disks or flash disks) the same as any other storage device. Virtual disks or partitions on external media can be encrypted as described above. However, you should disable mounting at boot time, because removable media is connected when the system is up and running.

If you encrypted your removable device with YaST, the GNOME desktop automatically recognizes the encrypted partition and prompts for the password when the device is detected. If you plug in a FAT-formatted removable device when running GNOME, the desktop user entering the password automatically becomes the owner of the device. For devices with a file system other than FAT, change the ownership explicitly for users other than `root` to give them read-write access to the device.

12.2 Encrypting files with GPG

GNU Privacy Guard (GPG) encryption software can be used to encrypt individual files and documents.

To encrypt a file with GPG, you need to generate a key pair first. To do this, run the `gpg --gen-key` and follow the on-screen instructions. When generating the key pair, GPG creates a user ID (UID) to identify the key based on your real name, comments and email address. You need this UID (or just a part of it like your first name or email address) to specify the key you want to use to encrypt a file. To find the UID of an existing key, use the `gpg --list-keys` command. To encrypt a file use the following command:

```
> gpg -e -a --cipher-algo AES256 -r UID FILE
```

Replace `UID` with part of the UID (for example, your first name) and `FILE` with the file you want to encrypt. For example:

```
> gpg -e -a --cipher-algo AES256 -r Tux secret.txt
```

This command creates an encrypted version of the specified file recognizable by the `.asc` file extension (in this example, it is `secret.txt.asc`).

`-a` formats the file as ASCII text, if you want the contents to be copy-able. Omit `-a` to create a binary file, which in the above example would be `secret.txt.gpg`.

To decrypt an encrypted file, use the following command:

```
> gpg -d -o DECRYPTED_FILE ENCRYPTED_FILE
```

Replace `DECRYPTED_FILE` with the desired name for the decrypted file and `ENCRYPTED_FILE` with the encrypted file you want to decrypt.

Keep in mind that the encrypted file can be decrypted using the same key that was used for encryption. To share an encrypted file with another person, you have to use that person's public key to encrypt the file.

12.3 Encrypting files with Rage

Rage is a secure file encryption software to encrypt files. It has keys that are easy to exchange with other people, and has secure defaults to prevent accidental misuse or leaks of sensitive data. We recommend Rage to encrypt files.

You can install Rage with:

```
> sudo zypper install rage-encryption
```

The recipient must first generate a key pair to encrypt a file with Rage:

```
> rage-keygen -o ~/rage.key 2 ~/rage.pub
```

Two files are created; *rage.pub* and *rage.key*.

rage.pub example

```
> cat file.pub
Public key: age17e4g67cs07jk3lmylyq6gduv26uf7tz7nm9jrsaxn8xxx9uc9amsdg4a5e
```

rage.key example

```
> cat file.key
# created: 2023-05-30T16:29:20+05:30
# public key: age17e4g67cs07jk3lmylyq6gduv26uf7tz7nm9jrsaxn8xxx9uc9amsdg4a5e
```



Important

file.key is a private key and should be kept confidential.

Encrypt

To encrypt a file, you need the generated public key:

```
> rage -e -r PUBLIC_KEY -o ENCRYPTED_FILE FILE
```

For example:

```
> rage -e -r age17e4g67cs07jk3lmylyq6gduv26uf7tz7nm9jrsaxn8xxx9uc9amsdg4a5e -o
test.txt.age test.txt
```

Decrypt

The encrypted file can be decrypted by the recipient who has the corresponding private key. To share an encrypted file with another person, you have to use that person's public key to encrypt the file.

```
> rage -d -i ~/rage.key -o DECRYPTED_FILE ENCRYPTED_FILE FILE
```

For example:

```
> rage -d -i ~/rage.key -o test.txt.decrypted test.txt.age
```

Passphrases

You can encrypt files with passphrases with the `-p` or `--passphrase` arguments. By default, Rage automatically generates a secure passphrase, but you also have the option to enter a passphrase.

```
> rage -e -p -o ENCRYPTED_FILE FILE
```

For example:

```
> rage -e -p -o test.txt.age test.txt
```

SSH

You can encrypt files with SSH (Secure Socket Shell) keys instead of Rage keys. Rage supports `ssh-rsa` and `ssh-ed25519` public keys, and decrypting with the respective private key file. `ssh-agent` and `ssh-sk(FIDO)` are not supported.

```
> rage -e -p -o ENCRYPTED_FILE FILE
```

For example:

```
> rage -e -p -o test.txt.age test.txt
```

For example:

```
> ssh-keygen -t ed25519
```

To encrypt:

```
> rage -e -a -R PUBLIC_KEY_FILE -o ENCRYPTED_FILE FILE
```

For example:

```
> rage -e -a -R id_ed25519.pub -o test.txt.age test.txt
```

To decrypt:

```
> rage -d -i SSH_PRIVATE_KEY_FILE -o DECRYPTED_FILE ENCRYPTED_FILE
```

For example:

```
> rage -d -i id_ed25519 -o test.txt.decrypted test.txt.age
```



Important

You must enter the path to the key and files.

Multiple identities

Rage can encrypt to multiple identities at the same time. Any of the recipient's private keys can be used to decrypt the file.

```
rage -e -a -R FIRST_SSH_PUBLIC_KEY-r FIRST_RAGE_PUBLIC_KEY... -o ENCRYPTED_FILE FILE
```

For example:

```
rage -e -a -R id_ed25519.pub -r  
age1h8equ4vs5pyp8ykw0z8m9n8m3psy6swme52ztth0v66frgu65ussm8gq0t -o -r  
age1y2lc7x59jcqvrpf3ppmj3f93ytaegfkdn15vrdiv83l8ekcae4sexgwkg test.txt.age  
test.txt
```



Tip

You can use the `-h` or `--help` argument to list all the Rage command arguments.

12.3.1 Additional Resources

- <https://github.com/str4d/rage>  Rage Encryption GitHub repository
- <https://github.com/C2SP/C2SP/blob/main/age.md>  Age Encryption GitHub repository

13 Storage encryption for hosted applications with `cryptctl`

Databases and similar applications are often hosted on external servers that are serviced by third-party staff. Certain data center maintenance tasks require third-party staff to directly access affected systems. In such cases, privacy requirements necessitate disk encryption.

`cryptctl` allows encrypting sensitive directories using LUKS and offers the following additional features:

- Encryption keys are located on a central server, which can be located on customer premises.
- Encrypted partitions are automatically remounted after an unplanned reboot.

`cryptctl` consists of two components:

- A client is a machine that has one or more encrypted partitions but does not permanently store the necessary key to decrypt those partitions. For example, clients can be cloud or otherwise hosted machines.
- The server holds encryption keys that can be requested by clients to unlock encrypted partitions.

You can also set up the `cryptctl` server to store encryption keys on a KMIP 1.3-compatible (Key Management Interoperability Protocol) server. In that case, the `cryptctl` server does not store the encryption keys of clients and is dependent upon the KMIP-compatible server to provide these.



Warning: `cryptctl` Server maintenance

Since the `cryptctl` server manages timeouts for the encrypted disks and, depending on the configuration, can also hold encryption keys, it should be under your direct control and managed by trusted personnel.

Additionally, it should be backed up regularly. Losing the server's data means losing access to encrypted partitions on the clients.

To handle encryption, `cryptctl` uses LUKS with aes-xts-256 encryption and 512-bit keys. Encryption keys are transferred using TLS with certificate verification.

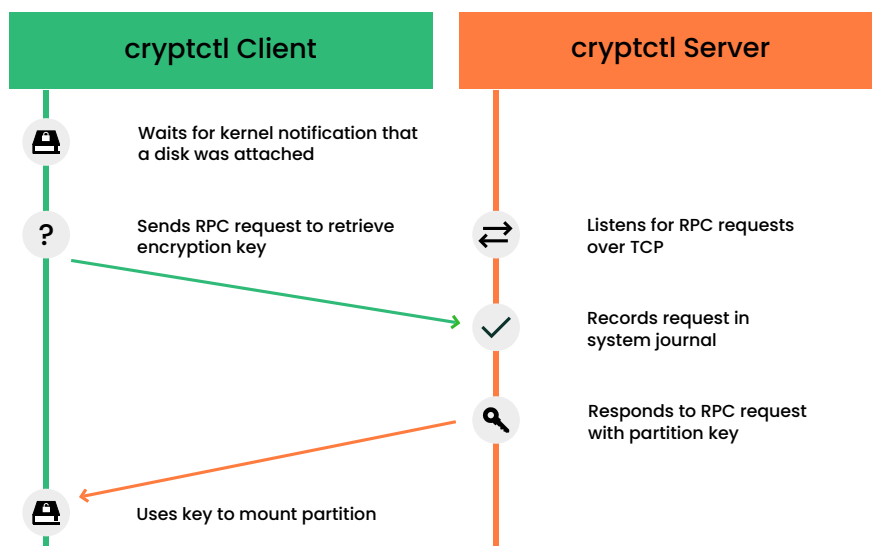

FIGURE 13.1: KEY RETRIEVAL WITH **cryptctl** (MODEL WITHOUT CONNECTION TO KMIP SERVER)



Note: Install **cryptctl**

Before continuing, make sure the package `cryptctl` is installed on all machines you intend to set up as servers or clients.

13.1 Setting up a **cryptctl** server

Before you can define a machine as a **cryptctl** client, you need to set up a machine as a **cryptctl** server.

Before beginning, choose whether to use a self-signed certificate to secure communication between the server and clients. If not, generate a TLS certificate for the server and have it signed by a certificate authority.

Additionally, you can have clients authenticate to the server using certificates signed by a certificate authority. To use this extra security measure, make sure to have a CA certificate at hand before starting this procedure.

1. As `root`, run:

```
# cryptctl init-server
```

2. Answer each of the following prompts and press `Enter` after every answer. If there is a default answer, it is shown in square brackets at the end of the prompt.

- a. Create a strong password, and protect it well. This password unlocks all partitions that are registered on the server.
- b. Specify the path to a PEM-encoded TLS certificate or certificate chain file or leave the field empty to create a self-signed certificate. If you specify a path, use an absolute path.
- c. If you want the server to be identified by a host name other than the default shown, specify a host name. `cryptctl` generates certificates which include the host name.
- d. Specify the IP address that belongs to the network interface that you want to listen on for decryption requests from the clients, then set a port number (the default is port 3737).
The default IP address setting, `0.0.0.0` means that `cryptctl` listens on all network interfaces for client requests using IPv4.
- e. Specify a directory on the server that holds the decryption keys for clients.
- f. Specify whether clients need to authenticate to the server using a TLS certificate. If you choose *No*, this means that clients authenticate using disk UUIDs. (However, communication is encrypted using the server certificate in any case.)
If you choose *Yes*, pick a PEM-encoded certificate authority to use for signing client certificates.
- g. Specify whether to use a KMIP 1.3-compatible server (or multiple such servers) to store encryption keys of clients. If you choose this option, provide the host names and ports for one or multiple KMIP-compatible servers.
Additionally, provide a user name, password, a CA certificate for the KMIP server, and a client identity certificate for the `cryptctl` server.



Important: No easy reconfiguration of KMIP setting

The setting to use a KMIP server cannot easily be changed later. To change this setting, both the `cryptctl` server and its clients need to be configured afresh.

- h. Finally, configure an SMTP server for e-mail notifications for encryption and decryption requests or leave the prompt empty to skip setting up e-mail notifications.



Note: Password-protected servers

`cryptctl` currently cannot send e-mail using authentication-protected SMTP servers. If that is necessary, set up a local SMTP proxy.

i. When asked whether to start the `cryptctl` server, enter `y`.

3. To check the status of the service `cryptctl-server`, use:

```
# systemctl status cryptctl-server
```

To reconfigure the server later, do either of the following:

- Run the command `cryptctl init-server` again. `cryptctl` proposes the existing settings as the defaults, so that you only need to specify the values that you want to change.
- Make changes directly in the configuration file `/etc/sysconfig/cryptctl-server`. However, to avoid issues, do not change the settings `AUTH_PASSWORD_HASH` and `AUTH_PASSWORD_SALT` manually. The values of these options need to be calculated correctly.

13.2 Setting up a `cryptctl` client

The following interactive setup of `cryptctl` is currently the only setup method.

Make sure the following preconditions are fulfilled:

- A `cryptctl` server is available over the network.
- There is a directory to encrypt.
- The client machine has an empty partition available that is large enough to fit the directory to encrypt.
- When using a self-signed certificate, the certificate (`*.crt` file) generated on the server is available locally on the client. Otherwise, the certificate authority of the server certificate must be trusted by the client.
- If you set up the server to require clients to authenticate using a client certificate, prepare a TLS certificate for the client which is signed by the CA certificate you chose for the server.

1. As `root`, run:

```
# cryptctl encrypt
```

2. Answer each of the following prompts and press `Enter` after every answer. If there is a default answer, it is shown in square brackets at the end of the prompt.
 - a. Specify the host name and port to connect to on the `cryptctl` server.
 - b. If you configured the server to have clients authenticate to it using a TLS certificate, specify a certificate and a key file for the client. The client certificate must be signed by the certificate authority chosen when setting up the server.
 - c. Specify the absolute path to the server certificate (the `*.crt` file).
 - d. Enter the encryption password that you specified when setting up the server.
 - e. Specify the path to the directory to encrypt. Specify the path to the empty partition that contains the encrypted content of the directory.
 - f. Specify the number of machines that are allowed to decrypt the partition simultaneously.

Then specify the timeout in seconds before additional machines are allowed to decrypt the partition after the last vital sign was received from the client or clients. When a machine unexpectedly stops working and then reboots, it needs to be able to unlock its partitions again. That means this timeout should be set to a time slightly shorter than the reboot time of the client.

Important: Timeout length

If the time is set too long, the machine cannot decrypt encrypted partitions on the first try. `cryptctl` then continues to periodically check whether the encryption key has become available. However, this introduces a delay.

If the timeout is set too short, machines with a copy of the encrypted partition have an increased chance of unlocking the partition first.

3. To start encryption, enter `yes`.

`cryptctl` encrypts the specified directory to the previously empty partition and then mounts the newly encrypted partition. The file system type is the same type as the original unencrypted file system.

Before creating the encrypted partition, `cryptctl` moves the unencrypted content of the original directory to a location prefixed with `cryptctl-moved-`.

4. To check that the directory is indeed mounted correctly, use:

```
> lsblk -o NAME,MOUNTPOINT,UUID
NAME                                MOUNTPOINT          UUID
[...]
sdc
└─sdc1                               PARTITION_UUID
   └─cryptctl-unlocked-sdc1 /secret-partition  UNLOCKED_UUID
```

`cryptctl` identifies the encrypted partition by its UUID. For the previous example, that is the UUID displayed next to `sdc1`.

On the server, you can check whether the directory was decrypted using `cryptctl`.

```
# cryptctl list-keys
```

For a successfully decrypted partition, you see output like:

```
2019/06/06 15:50:00 ReloadDB: successfully loaded database of 1 records
Total: 1 records (date and time are in zone EDT)
Used By      When                UUID  Max.Users  Num.Users  Mount Point
IP_ADDRESS  2019-06-06 15:00:50  UUID  1           1          /secret-partition
```

For a partition not decrypted successfully, you see output like:

```
2019/06/06 15:50:00 ReloadDB: successfully loaded database of 1 records
Total: 1 records (date and time are in zone EDT)
Used By      When                UUID  Max.Users  Num.Users  Mount Point
              2019-06-06 15:00:50  UUID  1           1          /secret-partition
```

See the difference in the empty `Used by` column.

Verify that the UUID shown is that of the previously encrypted partition.

5. After verifying that the encrypted partition works, delete the unencrypted content from the client. For example, use `rm`. For more safety, overwrite the content of the files before deleting them, for example, using `shred -u`.



Important: **shred** does not guarantee that data is erased

Depending on the type of storage media, using **shred** is not a guarantee that all data is removed. In particular, SSDs employ wear leveling strategies that render **shred** ineffective.

The configuration for the connection from client to server is stored in `/etc/sysconfig/cryptctl-client` and can be edited manually.

The server stores an encryption key for the client partition in `/var/lib/cryptctl/key-db/PARTITION_UUID`.

13.3 Configuring `/etc/fstab` for LUKS volumes

When configuring the mount point for a new file system encrypted with LUKS, YaST uses, by default, the name of the encrypted device in `/etc/fstab`. (For example, `/dev/mapper/cr_sda1`.) Using the device name, rather than the UUID or volume label, results in a more robust operation of systemd generators and other related tools.

You have the option to adjust that default behavior for each device, either with the Expert Partitioner in the installer, or via AutoYaST.

This change does not affect upgrades or any other scenario in which the mount points are already defined in `/etc/fstab`. Newly created mount points are affected, such as during the installation of a new system, or creating new partitions on running systems.

13.4 Checking partition unlock status using server-side commands

When a **cryptctl** client is active, it sends a “heartbeat” to the **cryptctl** server every 10 seconds. If the server does not receive a heartbeat from the client for the length of the timeout configured during the client setup, the server assumes that the client is offline. It then allows another client to connect (or allow the same client to reconnect after a reboot).

To see the usage status of all keys, use:

```
# cryptctl list-keys
```

The information under `Num.` `Users` shows whether the key is currently in use. To see more detail on a single key, use:

```
# cryptctl show-key UUID
```

This command shows information about mount point, mount options, usage options, the last retrieval of the key and the last three heartbeats from clients.

Additionally, you can use `journalctl` to find logs of when keys were retrieved.

13.5 Unlocking encrypted partitions manually

There are two ways of unlocking a partition manually, both of which are run on a client:

- **Online unlocking.** Online unlocking allows circumventing timeout or user limitations. This method can be used when there is a network connection between client and server but the client could not (yet) unlock the partition automatically. This method unlocks all encrypted partitions on a machine.

To use it, run `cryptctl online-unlock`. Be prepared to enter the password specified when setting up the server.

- **Offline unlocking.** This method can be used when a client cannot or must not be brought online to communicate with its server. The encryption key from the server must still be available. This method is meant as a last resort and can only unlock a single partition at a time.

To use it, run `cryptctl offline-unlock`. The server's key file for the requisite partition (`/var/lib/cryptctl/keydb/PARTITION_UUID`) needs to be available on the client.

13.6 Maintenance downtime procedure

To ensure that partitions cannot be decrypted during a maintenance downtime, turn off the client and disable the `cryptctl` server. You can do so by either:

- Stopping the service `cryptctl-server`:

```
# systemctl stop cryptctl-server
```

- Unplugging the `cryptctl` server from the network.

13.7 Setting up an HA environment for cryptctl-server service

To avoid downtimes when the cryptctl-server needs to be stopped for maintenance or suffers a damage, it is strongly recommended to set up the cryptctl-server in an HA environment. You need at least a two-node High Availability cluster for this. The following setup shows how to create a two-node HA cluster for cryptctl-server using self-signed certificates.

Make sure the following preconditions are fulfilled:

- At least two servers which have SUSE Linux Enterprise Server and the High Availability extension installed are available. All servers must also have the cryptctl package installed. All servers can reach each other via SSH.
- If you set up a new cluster, you need an additional IP address for the HA Web Console of the cluster (*AdminIP*).
- A separate IP address (*CrypServerIP*) is reserved for the cryptctl-server.
- A separate dns-name (*CrypServerHostName*) is reserved for the cryptctl-server and is resolved to the above IP address.
- An HA-enabled block device or NFS share is available to store the keys.
In our example, we use an NFS share: `nfs-server.example.org/data/cryptctl-keys`. It is mounted to the standard location `/var/lib/cryptctl/keydb`.
- It is strongly recommended to use an SBD device.

PROCEDURE 13.1: SETTING UP A CRYPTCTL TWO-NODE HA CLUSTER

1. Log in to *Node1* as `root`.
2. Set up a cryptctl-server as described in [Section 13.1, "Setting up a cryptctl server"](#). Use the following parameters:
 - a. To create the certificate, use the dedicated hostname *CrypServerHostName* of the cryptctl server. Do *not* use the host name of the host.
 - b. Use the dedicated IP address *CrypServerIP* of the cryptctl server. Do *not* use the default IP address setting.
 - c. Do not configure a KMIP server.

d. When asked whether to start the `cryptctl` server, enter `n`.

3. Set up a two-node HA cluster:

a.  Important

`Node1` must be the server where you have configured the `cryptctl` server.

On the machine where you have configured the `cryptctl` server, set up the first node as follows:

```
# crm cluster init -i NetDev -A AdminIP -n ClusterName
```

b. Log in via SSH to `Node2` and join the cluster from there:

```
# ssh Node2
# crm cluster join -y Node1
```

c. For more information, also see the [Installation and Setup Quick Start \(https://documentation.suse.com/sle-ha/html/SLE-HA-all/article-installation.html\)](https://documentation.suse.com/sle-ha/html/SLE-HA-all/article-installation.html).

4. Set up the resource group for the `cryptctl` server:

5. a. You can set up all needed resource agents and copy all files to all nodes with the `cryptctl crm-shell-script` in one step. We strongly recommend that you verify the setup in the first step:

```
# crm script verify cryptctl \
cert-path=/etc/cryptctl/servertls/CertificateFileName \
cert-key-path=/etc/cryptctl/servertls/CertificateKeyFileName \
virtual-ip:ip=CrypServerIP \
filesystem:device=DevicePath
filesystem:fstype=FileSystemType
```

b. If the check was successful, set up the cluster group by running the script as follows:

```
# crm script verify cryptctl \
cert-path=/etc/cryptctl/servertls/CertificateFileName \
cert-key-path=/etc/cryptctl/servertls/CertificateKeyFileName \
virtual-ip:ip=CrypServerIP \
filesystem:device=DevicePath
filesystem:fstype=FileSystemType
```

TABLE 13.1: LIST OF ALL PARAMETERS TO DEFINE THE RESOURCE GROUP WITH THE CRYPTCTL CRM SCRIPT.

Name	Mandatory	Default Value	Description
id	no	cryptctl	Name of the resource group.
cert-path	yes		The full path to the created certificate.
cert-key-path	yes		The full path to the created certificate key.
virtual-ip:id	no	cryptctl-vip	The ID of the virtual IP resource for the cryptctl server.
virtual-ip:ip	yes		The IP address of the cryptctl server.
virtual-ip:nic	no	Detected by the virtual-ip resource agent.	The network device the cryptctl server should be listening on. Only required if the device cannot be detected from the IP address.
virtual-ip:cidr_net-mask	no	Detected by the virtual-ip resource agent.	The numeric netmask of the IP address of the cryptctl server. Only required if the netmask cannot be detected from the IP address.
virtual-ip:broadcast	no	Detected by the virtual-ip resource agent.	The broadcast address of the IP address of the cryptctl server. Only required

Name	Mandatory	Default Value	Description
			if this cannot be detected from the IP address.
filesystem:id	no	cryptctl-filesystem	The ID of the file system resource containing the disk encryption keys and records.
filesystem:device	yes		The device containing the file system. This can be a block device like <code>/dev/sda...</code> or an NFS share path <code>server:/path</code> .
filesystem:directory	no	<code>/var/lib/cryptctl/keydb</code>	The directory where the device containing the file system is located. This can be a block device like <code>/dev/sda...</code> or an NFS share path <code>server:/path</code> .
filesystem:fstype	yes		The file system type (for example, NFS, XFS, EXT4).
filesystem:options	no	The default options of the selected file system.	Mount options for the file system.

13.8 More information

For more information, also see the project home page <https://github.com/SUSE/cryptctl/> .

14 User management

14.1 Various account checks

14.1.1 Unlocked accounts

It is important that all system and vendor accounts that are not used for logins are locked. To get a list of unlocked accounts on your system, you can check for accounts that do *not* have an encrypted password string starting with `!` or `*` in the `/etc/shadow` file. If you lock an account using either `passwd -l` or `usermod -L`, it puts a `!` in front of the encrypted password, effectively disabling the password. Many system and shared accounts are locked by default by having a `*`, `!!` or `!*` as the password field which renders the encrypted password into an invalid string. Hence, to get a list of all unlocked (encryptable) accounts, run the following command:

```
# egrep -v ':\*|:\!' /etc/shadow | awk -F: '{print $1}'
```

Also make sure all accounts have an `x` in the password field in `/etc/passwd`. The following command lists all accounts that do not have a `x` in the password field:

```
# grep -v ':x:' /etc/passwd
```

An `x` in the password field means that the password has been shadowed, for example, the encrypted password needs to be looked up in the `/etc/shadow` file. If the password field in `/etc/passwd` is empty, then the system does not look up the shadow file and it prompts the user for a password at the login prompt.

14.1.2 Unused accounts

All system or vendor accounts that are not being used by users, applications, by the system or by daemons should be removed from the system. You can use the following command to find out if there are any files owned by a specific account:

```
# find / -path /proc -prune -o -user ACCOUNT -ls
```

The `-prune` option in this example is used to skip the `/proc` file system. If you are sure that an account can be deleted, you can remove the account using the following command:

```
# userdel -r ACCOUNT
```

Without the `-r` option, `userdel` does not delete the user's home directory and mail spool (`/var/spool/mail/USER`). Many system accounts do not have a home directory.

14.2 Enabling password aging

Password expiration is a general best practice, but might need to be excluded for certain system and shared accounts (for example, Oracle). Expiring passwords on those accounts could lead to system outages if the application account expires.

Typically a corporate policy should be developed that dictates rules/procedures regarding password changes for system and shared accounts. However, normal user account passwords should expire automatically. The following example shows how password expiration can be set up for individual user accounts.

The following files and parameters in the table can be used when a new account is created with the `useradd` command. Settings such as these are stored for each user account in the `/etc/shadow` file. If using the YaST tool (*User and Group Management*) to add users, the settings are available on a per-user basis. Here are the various settings, some of which can also be system-wide (for example, modification of `/etc/login.defs` and `/etc/default/useradd`):

<code>/etc/login.defs</code>	<code>PASS_MAX_DAYS</code>	Maximum number of days a password is valid.
<code>/etc/login.defs</code>	<code>PASS_MIN_DAYS</code>	Minimum number of days before a user can change the password since the last change.
<code>/etc/login.defs</code>	<code>PASS_WARN_AGE</code>	Number of days between the last password change and the next password change reminder.

<u>/etc/default/useradd</u>	<u>INACTIVE</u>	Number of days after password expiration until the account is disabled.
<u>/etc/default/useradd</u>	<u>EXPIRE</u>	Account expiration date in the format YYYY-MM-DD.



Note: Existing users not affected

Users created before these modifications are not affected.

Ensure that the above parameters are changed in the /etc/login.defs and /etc/default/useradd files. A review of the /etc/shadow file shows how these settings are stored after adding a user.

To create a new user account, execute the following command:

```
# useradd -c "TEST_USER" -g USERS TEST
```

The -g option specifies the primary group for this account:

```
# id TEST
uid=509(test) gid=100(users) groups=100(users)
```

The settings in /etc/login.defs and /etc/default/useradd are recorded for the test user in the /etc/shadow file as follows:

```
# grep TEST /etc/shadow
test:!!:12742:7:60:7:14:::
```

Password aging can be modified at any time by use of the chage command. To disable password aging for system and shared accounts, you can run the following chage command:

```
# chage -M -1 SYSTEM_ACCOUNT_NAME
```

To get password expiration information:

```
# chage -l SYSTEM_ACCOUNT_NAME
```

For example:

```
# chage -l TEST
Minimum: 7
Maximum: 60
```

```
Warning: 7
Inactive: 14
Last Change: Jan 11, 2015
Password Expires: Mar 12, 2015
Password Inactive: Mar 26, 2015
Account Expires: Never
```

14.3 Stronger password enforcement

On an audited system, it is important to restrict people from using simple passwords that can be cracked too easily. Writing down complex passwords is all right if stored securely. Some argue that strong passwords protect you against dictionary attacks, and those types of attacks can be defeated by locking accounts after a few failed attempts. However, this is not always an option. If set up like this, locking system accounts could bring down your applications and systems, which would be nothing short of a denial-of-service attack—another issue.

At any rate, it is important to practice effective password management security. Most companies require that passwords have at least a number, one lowercase letter, and one uppercase letter. Policies vary, but maintaining a balance between password strength/complexity and management can be difficult.

14.4 Password and login management with PAM

Linux-PAM (Pluggable Authentication Modules for Linux) is a suite of shared libraries that enable the local system administrator to choose how applications authenticate users.

It is strongly recommended to familiarize oneself with the capabilities of PAM and how this architecture can be leveraged to provide the best authentication setup for an environment. This configuration can be done once, and implemented across all systems (a standard), or can be enhanced for individual hosts (enhanced security—by host/service/application). The key is to realize how flexible the architecture is.

To learn more about the PAM architecture, find PAM documentation in the [/usr/share/doc/packages/pam](#) directory (in a variety of formats).

The following discussions are examples of how to modify the default PAM stacks—specifically around password policies—for example password strength, password re-use, and account locking. While these are only a few of the possibilities, they serve as a good start and demonstrate PAM's flexibility.

! Important: **pam-config** limitations

The **pam-config** tool can be used to configure the common-{account,auth,password,session} PAM configuration files, which contain global options. These files include the following comment:

```
# This file is autogenerated by pam-config. All changes
# will be overwritten.
```

Individual service files, such as `login`, `password`, `sshd`, and `su` must be edited directly. You can elect to edit all files directly, and not use **pam-config**, though **pam-config** includes useful features such as converting an older configuration, updating your current configuration, and sanity checks. For more information, see `man 8 pam-config`.

14.4.1 Password strength

SUSE Linux Enterprise Server can leverage the `pam_cracklib` library to test for weak passwords—and to suggest using a stronger one if it determines obvious weakness. The following parameters represent an example that could be part of a corporate password policy or something required because of audit constraints.

The PAM libraries follow a defined flow. The best way to design the perfect stack usually is to consider all of the requirements and policies and draw out a flow chart.

TABLE 14.1: SAMPLE RULES/CONSTRAINTS FOR PASSWORD ENFORCEMENT

<code>pam_cracklib.so</code>	<code>minlen=8</code>	Minimum length of password is 8
<code>pam_cracklib.so</code>	<code>lcredit=-1</code>	Minimum number of lowercase letters is 1
<code>pam_cracklib.so</code>	<code>ucredit=-1</code>	Minimum number of uppercase letters is 1
<code>pam_cracklib.so</code>	<code>dcredit=-1</code>	Minimum number of digits is 1
<code>pam_cracklib.so</code>	<code>ocredit=-1</code>	Minimum number of other characters is 1

To set up these password restrictions, use the **pam-config** tool to specify the parameters you want to configure. For example, the minimum length parameter could be modified like this:

```
> sudo pam-config -a --cracklib-minlen=8 --cracklib-retry=3 \
--cracklib-lcredit=-1 --cracklib-ucredit=-1 --cracklib-dcredit=-1 \
--cracklib-ocredit=-1 --cracklib
```

Now verify that the new password restrictions work for new passwords. Log in to a non-root account and change the password using the **passwd** command. Note that the above requirements are not enforced if you run the **passwd** command under root.

14.4.2 Restricting use of previous passwords

The `pam_pwhistory` module can be used to configure the number of previous passwords that cannot be reused. The following command implements password restrictions on a system so that a password cannot be reused for at least six months:

```
> sudo pam-config -a --pwhistory --pwhistory-remember=26
```

Recall that in the section [Section 14.2, “Enabling password aging”](#) we set `PASS_MIN_DAYS` to `7`, which specifies the minimum number of days allowed between password changes. Therefore, if `pam_unix` is configured to remember `26` passwords, then the previously used passwords cannot be reused for at least six months (26×7 days).

The PAM configuration (`/etc/pam.d/common-password`) resulting from the **pam-config** command looks like the following:

```
auth    required  pam_env.so
auth    required  pam_unix.so    try_first_pass
account required  pam_unix.so    try_first_pass
password requisite pam_cracklib.so
password required  pam_pwhistory.so    remember=26
password optional  pam_gnome_keyring.so    use_authtok
password required  pam_unix.so    use_authtok nullok shadow try_first_pass
session required  pam_limits.so
session required  pam_unix.so    try_first_pass
session optional  pam_umask.so
```

14.4.3 Locking user accounts after too many login failures

Locking accounts after a defined number of failed ssh, login, su, or sudo attempts is a common security practice. However, this could lead to outages if an application, admin, or root user is locked out.

Important: Denial-of-service attacks

Password failure counts can easily be abused to cause denial-of-service attacks by deliberately creating login failures.

Only use password failure counts if you have to. Restrict locking to the necessary minimum, and do not lock critical accounts. Keep in mind that locking not only applies to human users but also to system accounts used to provide services.

SUSE Linux Enterprise Server does not lock accounts by default, but provides PAM module **pam_tally2** to easily implement password failure counts. Add the following line to the top of /etc/pam.d/login to lock out all users (except for root) after six failed logins, and to automatically unlock the accounts after ten minutes:

```
auth required pam_tally2.so deny=6 unlock_time=600
```

This is an example of a complete /etc/pam.d/login file:

```
##%PAM-1.0
auth    requisite    pam_nologin.so
auth    include      common-auth
auth    required     pam_tally2.so deny=6 unlock_time=600
account include     common-account
account required    pam_tally2.so
password include    common-password
session required    pam_loginuid.so
session include     common-session
#session optional   pam_lastlog.so nowtmp showfailed
session optional    pam_mail.so standard
```

You can also lock out root, though obviously you must be very certain you want to do this:

```
auth required pam_tally2.so deny=6 even_deny_root unlock_time=600
```

You can define a different lockout time for root:

```
auth required pam_tally2.so deny=6 root_unlock_time=120 unlock_time=600
```

If you want to require the administrator to unlock accounts, leave out the `unlock_time` option. The next two example commands display the number of failed login attempts and how to unlock a user account:

```
> sudo pam_tally2 -u username
Login          Failures Latest failure    From
username             6    12/17/19 13:49:43 pts/1

> sudo pam_tally2 -r -u username
```

The default location for attempted accesses is recorded in `/var/log/tallylog`.

If the user succeeds in logging in after the login timeout expires, or after the administrator resets their account, the counter resets to 0.

Configure other login services to use `pam_tally2` in their individual configuration files in `/etc/pam.d/`: `sshd`, `su`, `sudo`, `sudo-i`, and `su-l`.

14.5 Restricting root logins

By default, the `root` user is assigned a password and can log in using various methods—for example, on a local terminal, in a graphical session, or remotely via SSH. These methods should be restricted as far as possible. Shared usage of the root account should be avoided. Instead, individual administrators should use tools such as `su` or `sudo` (for more information, type `man 1 su` or `man 8 sudo`) to obtain elevated privileges. This allows associating `root` logins with particular users. This also adds another layer of security; not only the `root` password, but both the `root` and the password of an administrator's regular account would need to be compromised to gain full root access. This section explains how to limit direct root logins on the different levels of the system.

14.5.1 Restricting local text console logins

TTY devices provide text-mode system access via the console. For desktop systems these are accessed via the local keyboard or—in case of server systems—via input devices connected to a KVM switch or a remote management card (for example, ILO and DRAC). By default, Linux offers six different consoles, which can be switched to via the key combinations `Alt-F1` to `Alt-F6`, when running in text mode, or `Ctrl-Alt-F1` to `Ctrl-Alt-F6` when running in a graphical session. The associated terminal devices are named `tty1` to `tty6`.

The following steps restrict root access to the first TTY. Even this access method is only meant for emergency access to the system and should never be used for everyday system administration tasks.



Note

The steps shown here are tailored towards PC architectures (x86 and AMD64/Intel 64). On architectures such as POWER, different terminal device names than `tty1` can be used. Be careful not to lock yourself out by specifying wrong terminal device names. You can determine the device name of the terminal you are currently logged in to by running the `tty` command. Be careful not to do this in a virtual terminal, such as via SSH or in a graphical session (device names `/dev/pts/N`), but only from an actual login terminal reachable via `Alt - FN`.

PROCEDURE 14.1: RESTRICTING ROOT LOGINS ON LOCAL TTYS

1. Ensure that the PAM stack configuration file `/etc/pam.d/login` contains the `pam_securetty` module in the `auth` block:

```
auth    requisite    pam_nologin.so
auth    [user_unknown=ignore success=ok ignore=ignore auth_err=die default=bad]
pam_securetty.so noconsole
auth    include      common-auth
```

This includes the `pam_securetty` module during the authentication process on local consoles, which restricts `root` to logging in only on TTY devices that are listed in the file `/etc/securetty`.

2. Remove all entries from `/etc/securetty` except one. This limits the access to TTY devices for root.

```
#
# This file contains the device names of tty lines (one per line,
# without leading /dev/) on which root is allowed to login.
#
tty1
```

3. Check whether logins to other terminals are rejected for `root`. A login on `tty2`, for example, should be rejected immediately, without even querying the account password. Also make sure that you can still successfully log in to `tty1` and thus that `root` is not locked out of the system.

! Important: Do not add pam_securetty module

Do not add the `pam_securetty` module to the `/etc/pam.d/common-auth` file. This would break the `su` and `sudo` commands, because these tools would then also reject `root` authentications.

! Important

These configuration changes also cause `root` logins on serial consoles such as `/dev/ttyS0` to be denied. In case you require such use cases, you need to list the respective TTY devices additionally in the `/etc/securetty` file.

14.5.2 Restricting graphical session logins

To improve security on your server, avoid using graphical environments at all. Graphical programs are often not designed to be run as `root` and can contain security issues than console programs. If you require a graphical login, use a non-`root` login. Configure your system to disallow `root` from logging in to graphical sessions.

To prevent `root` from logging in to graphical sessions, you can apply the same basic steps as outlined in [Section 14.5.1, “Restricting local text console logins”](#). Just add the `pam_securetty` module to the PAM stack file belonging to the display manager—for example, `/etc/pam.d/gdm` for GDM. The graphical session also runs on a TTY device: by default, `tty7`. Therefore, if you restrict `root` logins to `tty1`, then `root` is denied login in the graphical session.

14.5.3 Restricting SSH logins

By default, the `root` user is also allowed to log in to a machine remotely via the SSH network protocol (if the SSH port is not blocked by the firewall). To restrict this, make the following change to the OpenSSH configuration:

1. Edit `/etc/ssh/sshd_config` and adjust the following parameter:

```
PermitRootLogin no
```

2. Restart the `sshd` service to make the changes effective:

```
systemctl restart sshd.service
```



Note

Using the PAM `pam_securetty` module is not suitable in case of OpenSSH, because not all SSH logins go through the PAM stack during authorization (for example, when using SSH public-key authentication). Additionally, an attacker could differentiate between a wrong password and a successful login that was only rejected later on by policy.

14.6 Restricting `sudo` users

The `sudo` command allows users to execute commands in the context of another user, typically the `root` user. The `sudo` configuration consists of a rule-set that defines the mappings between commands to execute and their allowed source and target users and groups. The configuration is stored in the file `/etc/sudoers`. For more information about `sudo`, refer to *Book "Administration Guide", Chapter 2 "sudo basics"*.

By default, `sudo` asks for the `root` password on SUSE systems. Unlike `su` however, `sudo` remembers the password and allows further commands to be executed as `root` without asking for the password again for five minutes. Therefore, `sudo` should be enabled for selected administrator users only.

PROCEDURE 14.2: RESTRICTING `sudo` FOR NORMAL USERS

1. Edit file `/etc/sudoers`, for example by executing `visudo`.
2. Comment out the line that allows every user to run every command as long as they know the password of the user they want to use. Afterwards, it should look like this:

```
#ALL ALL=(ALL) ALL # WARNING! Only use this together with 'Defaults targetpw'!
```

3. Uncomment the following line:

```
%wheel ALL=(ALL) ALL
```

This limits the functionality described above to members of the group `wheel`. You can use a different group as `wheel` might have other implications that might not be suitable depending on your setup.

4. Add users that should be allowed to use `sudo` to the chosen group. To add the user `tux` to the group `wheel`, use:

```
usermod -aG wheel tux
```

To get the new group membership, users have to log out and back in again.

5. Verify the change by running a command with a user not in the group you have chosen for access control. You should see the error message:

```
wilber is not in the sudoers file. This incident will be reported.
```

Next, try the same with a member of the group. They should still be able to execute commands via **sudo**.

This configuration only limits the **sudo** functionality. The **su** command is still available to all users. If there are other ways to access the system, users with knowledge of the **root** password can easily execute commands via this vector.

14.7 Setting an inactivity timeout for interactive shell sessions

It can be a good idea to terminate an interactive shell session after a certain period of inactivity. For example, to prevent open, unguarded sessions, or to avoid wasting system resources.

By default, there is no inactivity timeout for shells. Nothing happens if a shell stays open and unused for days or even years. However, it is possible to configure most shells so that idle sessions terminate automatically after a certain amount of time. The following example shows how to set an inactivity timeout for several common types of shells.

The inactivity timeout can be configured for login shells only or for all interactive shells. In the latter case, the inactivity timeout runs individually for each shell instance. This means that timeouts accumulate. When a sub- or child-shell is started, a new timeout begins for the sub- or child-shell, and only afterwards the timeout of the parent continues running.

The following table contains configuration details for a selection of common shells shipped with SUSE Linux Enterprise Server:

package	shell personalities	shell variable	time unit	readonly setting	config path (only login shell)	config path (all shells)
<u>bash</u>	<u>bash, sh</u>	<u>TMOUT</u>	seconds	<u>read-only</u> <u>TMOUT=</u>	<u>/etc/pro-</u> <u>file.lo-</u> <u>cal, /</u> <u>etc/pro-</u> <u>file.d/</u>	<u>/etc/</u> <u>bash.bashrc</u>
<u>mksh</u>	<u>ksh,</u> <u>lksh,</u> <u>mksh, pd-</u> <u>ksh</u>	<u>TMOUT</u>	seconds	<u>read-only</u> <u>TMOUT=</u>	<u>/etc/pro-</u> <u>file.lo-</u> <u>cal, /</u> <u>etc/pro-</u> <u>file.d/</u>	<u>/etc/</u> <u>ksh.k-</u> <u>shrc.lo-</u> <u>cal</u>
<u>tcsh</u>	<u>csh, tc-</u> <u>sh</u>	<u>autolo-</u> <u>gout</u>	minutes	<u>set -r</u> <u>autolo-</u> <u>gout=</u>	<u>/etc/</u> <u>csh.lo-</u> <u>gin.local</u>	<u>/etc/</u> <u>csh.c-</u> <u>shrc.lo-</u> <u>cal</u>
<u>zsh</u>	<u>zsh</u>	<u>TMOUT</u>	seconds	<u>readonly</u> <u>TMOUT=</u>	<u>/etc/pro-</u> <u>file.lo-</u> <u>cal, /</u> <u>etc/pro-</u> <u>file.d/</u>	<u>/etc/</u> <u>zsh.zshrc.lo-</u> <u>cal</u>

Every listed shell supports an internal timeout shell variable that can be set to a specific time value to cause the inactivity timeout. If you want to prevent users from overriding the timeout setting, you can mark the corresponding shell timeout variable as read-only. The corresponding variable declaration syntax is also found in the table above.



Note: No protection from hostile users

This feature is only helpful for avoiding risks if a user is forgetful or follows unsafe practices. It does not protect against hostile users. The timeout only applies to interactive wait states of a shell. A malicious user can always find ways to circumvent the timeout and keep their session open regardless.

To configure the inactivity timeout, you need to add the matching timeout variable declaration to each shell's start-up script. Use either the path for login shells only, or the one for all shells, as listed in the table. The following example uses paths and settings that are suitable for **bash** and **ksh** to set up a read-only login shell timeout that cannot be overridden by users. Create the file `/etc/profile.d/timeout.sh` with the following content:

```
# /etc/profile.d/timeout.sh for SUSE Linux
#
# Timeout in seconds until the bash/ksh session is terminated
# in case of inactivity.
# 24h = 86400 sec
readonly TMOUT=86400
```



Tip

We recommend using the **screen** tool to detach sessions before logging out. **screen** sessions are not terminated and can be re-attached whenever required. An active session can be locked without logging out (read about `Ctrl - A - X` / **lockscreen** in **man screen** for details).

14.8 Preventing accidental denial of service

Linux allows you to set limits on the amount of system resources that users and groups can consume. This is also useful if bugs in programs cause them to use up too many resources (for example, memory leaks), slow down the machine, or even render the system unusable. Incorrect settings can allow programs to use too many resources, which might make the server unresponsive to new connections or even local logins (for example, if a program uses up all available file handles on the host). This can also be a security concern if someone is allowed to

consume all system resources and therefore cause a denial-of-service attack—either unplanned, or worse, planned. Setting resource limits for users and groups might be an effective way to protect systems, depending on the environment.

14.8.1 Example for restricting system resources

The following example demonstrates the practical usage of setting or restricting system resource consumption for an Oracle user account. For a list of system resource settings, see </etc/security/limits.conf> or `man limits.conf`.

Most shells, such as Bash, provide control over various resources (for example, the maximum allowable number of open file descriptors or the maximum number of processes) that are available on a per-user basis. To examine all current limits in the shell, execute:

```
# ulimit -a
```

For more information on `ulimit` for the Bash shell, examine the Bash man pages.



Important: Setting limits for SSH sessions

Setting “hard” and “soft” limits might not have the expected results when using an SSH session. To see valid behavior, it might be necessary to log in as root, and then `su` to the ID with limits (for example, `Oracle` in these examples). Resource limits should also work assuming the application was started automatically during the boot process. It might be necessary to set `UsePrivilegeSeparation` in `/etc/ssh/sshd_config` to `no` and restart the SSH daemon (`systemctl restart sshd`) if it seems that the changes to resource limits are not working (via SSH). However, this is not generally recommended, as it weakens a system's security.



Tip: Disabling password logins via `ssh`

You can add extra security to your server by disabling password authentication for SSH. Remember that you need to have SSH keys configured, otherwise you cannot access the server. To disable password login, add the following lines to `/etc/ssh/sshd_config`:

```
UseLogin no
UsePAM no
PasswordAuthentication no
PubkeyAuthentication yes
```

In this example, a change to the number of file handles or open files that the user `oracle` can use is made by editing `/etc/security/limits.conf` as `root` making the following changes:

```
oracle      soft   nofile   4096
oracle      hard   nofile   63536
```

The soft limit in the first line defines the limit on the number of file handles (open files) that the `oracle` user has after login. If the user sees error messages about running out of file handles, then the user can increase the number of file handles like in this example up to the hard limit (in this example 63536) by executing:

```
# ulimit -n 63536
```

You can set the soft and hard limits higher if necessary.



Note: Caution with using ulimits

It is important to be judicious with the usage of ulimits. Allowing a “hard” limit for `nofile` for a user that is equal to the kernel limit (`/proc/sys/fs/file-max`) is bad. If the user consumes all the available file handles, the system cannot initiate new logins, since it is not possible to access the PAM modules required to perform a login.

You also need to ensure that `pam_limits` is either configured globally in `/etc/pam.d/common-auth`, or for individual services like SSH, su, login and telnet in:

`/etc/pam.d/sshd` (for SSH)

`/etc/pam.d/su` (for su)

`/etc/pam.d/login` (local logins and telnet)

If you do not want to enable it for all logins, there is a specific PAM module that reads the `/etc/security/limits.conf` file. Entries in PAM configuration directives have entries like:

```
session    required   /lib/security/pam_limits.so
session    required   /lib/security/pam_unix.so
```

Changes are not immediate and require a new login session:

```
# su - oracle
> ulimit -n
4096
```

These examples are specific to the Bash shell; **ulimit** options are different for other shells. The default limit for the user `oracle` is `4096`. To increase the number of file handles the user `oracle` can use to `63536`, execute:

```
# su - oracle
> ulimit -n
4096
> ulimit -n 63536
> ulimit -n
63536
```

Making this permanent requires the addition of the setting, **ulimit -n 63536**, (again, for Bash) to the user's profile (`~/.bashrc` or `~/.profile` file), which is the user start-up file for the Bash shell on SUSE Linux Enterprise Server (to verify your shell, run: **echo \$SHELL**). To do this you could run the following commands for the Bash shell of the user `oracle`:

```
# su - oracle
> cat >> ~oracle/.bash_profile << EOF
ulimit -n 63536
EOF
```

14.9 Displaying login banners

It is often necessary to place a banner on login screens on all servers for legal/audit policy reasons or to give security instructions to users.

To print a login banner *after* a user logs in on a text based terminal, for example, using SSH or on a local console, you can use the file `/etc/motd` (`motd` = message of the day). The file exists by default on SUSE Linux Enterprise Server, but it is empty. Simply add content to the file that is applicable/required by the organization.



Note: Banner length

Try to keep the login banner content to a single terminal page (or less), as it scrolls the screen if it does not fit, making it more difficult to read.

You can also have a login banner printed *before* a user logs in on a text based terminal. For local console logins, you can edit the `/etc/issue` file, which causes the banner to be displayed before the login prompt. For logins via SSH, you can edit the “Banner” parameter in the `/etc/ssh/sshd_config` file, which then appropriately displays the banner text before the SSH login prompt.

For graphical logins via GDM, you can follow [the GNOME admin guide \(https://help.gnome.org/admin/system-admin-guide/stable/login-banner.html.en\)](https://help.gnome.org/admin/system-admin-guide/stable/login-banner.html.en) to set up a login banner. Furthermore, you can make the following changes to require a user to acknowledge the legal banner by selecting *Yes* or *No*. Edit the `/etc/gdm/Xsession` file and add the following lines at the *beginning* of the script:

```
if ! /usr/bin/gdialog --yesno '\nThis system is classified...\n' 10 10; then
    /usr/bin/gdialog --infobox 'Aborting login'
    exit 1;
fi
```

The text `This system is classified...` needs to be replaced with the desired banner text. This dialog does not prevent a login from progressing. For more information about GDM scripting, refer to the [GDM Admin Manual \(https://help.gnome.org/admin/gdm/stable/configuration.html.en#scripting\)](https://help.gnome.org/admin/gdm/stable/configuration.html.en#scripting).

14.10 Connection accounting utilities

Here is a list of commands you can use to get data about user logins:

who. Lists currently logged in users.

w. Shows who is logged in and what they are doing.

last. Shows a list of the most recent logged in users, including login time, logout time, login IP address, etc.

lastb. Same as **last**, except that by default it shows `/var/log/btmp`, which contains all the bad login attempts.

lastlog. This command reports data maintained in `/var/log/lastlog`, which is a record of the last time a user logged in.

ac. Available after installing the `acct` package. Prints the connect time in hours on a per-user basis or daily basis, etc. This command reads `/var/log/wtmp`.

dump-utmp. Converts raw data from /var/run/utmp or /var/log/wtmp into ASCII-parseable format.

Also check the /var/log/messages file, or the output of **journalctl** if no logging facility is running. See Book *“Administration Guide”*, Chapter 21 **“journalctl: query the systemd journal”** for more information on the systemd journal.

15 Restricting cron and at

This chapter explains how to restrict access to the `cron` and `at` daemons to improve the security of a system.

15.1 Restricting the cron daemon

The `cron` system is used to automatically run commands in the background at predefined times. For more information about `cron`, refer to the *Book "Administration Guide", Chapter 30 "Special system features", Section 30.1.2 "The cron package"*.

The `cron.allow` file specifies a list of users that are allowed to execute jobs via `cron`. The file does not exist by default, so all users can create `cron` jobs—except for those listed in `cron.deny`.

To prevent users except for `root` from creating `cron` jobs, perform the following steps.

1. Create an empty file `/etc/cron.allow`:

```
tux > sudo touch /etc/cron.allow
```

2. Allow users to create `cron` jobs by adding their user names to the file:

```
tux > sudo echo "tux" >> /etc/cron.allow
```

3. To verify, try creating a `cron` job as non-root user listed in `cron.allow`. You should see the message:

```
tux > crontab -e
no crontab for tux - using an empty one
```

Quit the `crontab` editor and try the same with a user *not* listed in the file (or before adding them in step 2 of this procedure):

```
wilber > crontab -e
You (wilber) are not allowed to use this program (crontab)
See crontab(1) for more information
```



Important: Existing cron jobs

Implementing `cron.allow` prevents users from creating new `cron` jobs. Existing jobs run, even for users listed in `cron.deny`. To prevent this, create the file as described and remove existing user crontabs from the directory `/var/spool/cron/tabs` to ensure they are not run anymore.



Note: Switching to systemd timer units

You should also consider switching to `systemd` timer units, as they allow for more powerful and reliable task execution. By default, users cannot use them to run code when they are not logged in. This limits the way users can interact with the system while not being connected to it.

For more information about `systemd` timer units, refer to *Book "Administration Guide", Chapter 19 "The systemd daemon", Section 19.7 "systemd timer units"*.

15.2 Restricting the at scheduler

The `at` job execution system allows users to schedule one-time running jobs. The `at.allow` file specifies a list of users that are allowed to schedule jobs via `at`. The file does not exist by default, so all users can schedule `at` jobs—except for those listed in `at.deny`.)

To prevent users except for `root` from scheduling jobs with `at`, perform the following steps.

1. Create an empty file `/etc/at.allow`:

```
tux > sudo touch /etc/at.allow
```

2. Allow users to schedule jobs with `at` by adding their user names to the file:

```
tux > sudo echo "tux" >> /etc/at.allow
```

3. To verify, try scheduling a job as non-root user listed in `at.allow`:

```
tux > at 00:00
at>
```

Quit the `at` prompt with `Ctrl - C` and try the same with a user *not* listed in the file (or before adding them in step 2 of this procedure):

```
wilber > at 00:00  
You do not have permission to use at.
```



Note: Uninstalling `at`

`at` is not widely used anymore. If you do not have valid use cases, consider uninstalling the daemon instead of just restricting its access.

16 Spectre/Meltdown checker

spectre-meltdown-checker is a shell script to test if your system is vulnerable to the several speculative execution vulnerabilities that are in nearly all CPUs manufactured in the past 20 years. This is a hardware flaw that potentially allows an attacker to read all data on the system. On cloud computing services, where multiple virtual machines are on a single physical host, an attacker can gain access to all virtual machines. Fixing these vulnerabilities requires redesigning and replacing CPUs. Until this happens, there are several software patches that mitigate these vulnerabilities. If you have kept your SUSE systems updated, all these patches should already be installed.

spectre-meltdown-checker generates a detailed report. It is impossible to guarantee that your system is secure, but it shows you which mitigations are in place, and potential vulnerabilities.

16.1 Using **spectre-meltdown-checker**

Install the script, and then run it as root without any options:

```
# zypper in spectre-meltdown-checker
# spectre-meltdown-checker.sh
```

You see colorful output like *Figure 16.1, “Output from spectre-meltdown-checker”*:

```
dreamer:/home/carla # spectre-meltdown-checker.sh
Spectre and Meltdown mitigation detection tool v0.40

Checking for vulnerabilities on current system
Kernel is Linux 4.12.14-lp151.28.13-default #1 SMP Wed Aug 7 07:20:16 UTC 2019 (0c09ad2) x86_64
CPU is Intel(R) Xeon(R) CPU E5-1620 v3 @ 3.50GHz

Hardware check
* Hardware support (CPU microcode) for mitigation techniques
* Indirect Branch Restricted Speculation (IBRS)
  * SPEC_CTRL MSR is available: YES
  * CPU indicates IBRS capability: YES (SPEC_CTRL feature bit)
* Indirect Branch Prediction Barrier (IBPB)
  * PRED_CMD MSR is available: YES
  * CPU indicates IBPB capability: YES (SPEC_CTRL feature bit)
* Single Thread Indirect Branch Predictors (STIBP)
  * SPEC_CTRL MSR is available: YES
  * CPU indicates STIBP capability: YES (Intel STIBP feature bit)
* Speculative Store Bypass Disable (SSBD)
  * CPU indicates SSBD capability: YES (Intel SSBD)
* L1 data cache invalidation
  * FLUSH_CMD MSR is available: YES
  * CPU indicates L1D flush capability: YES (L1D flush feature bit)
* Enhanced IBRS (IBRS_ALL)
  * CPU indicates ARCH_CAPABILITIES MSR availability: NO
  * ARCH_CAPABILITIES MSR advertises IBRS_ALL capability: NO
```

FIGURE 16.1: OUTPUT FROM SPECTRE-MELTDOWN-CHECKER

`spectre-meltdown-checker.sh --help` lists all options. It is useful to pipe plain text output, with no colors, to a file:

```
# spectre-meltdown-checker.sh --no-color | tee filename.txt
```

The previous examples are on a running system, which is the default. You may also run `spectre-meltdown-checker` offline by specifying the paths to the kernel, config and System.map files:

```
# cd /boot
# spectre-meltdown-checker.sh \
--no-color \
--kernel vmlinuz-6.4.0-150600.9-default \
--config config-6.4.0-150600.9-default \
--map System.map-6.4.0-150600.9-default | tee filename.txt
```

Other useful options are:

`--verbose, -v`

Increase verbosity; repeat for more verbosity, for example `-v -v -v`

`--explain`

Print human-readable explanations

`--batch [short] [json] [nrpe] [prometheus]`

Format output in various machine-readable formats



Important: `--disclaimer` option

`spectre-meltdown-checker.sh --disclaimer` provides important information about what the script does, and does not do.

16.2 More information

For more information, see the following references:

- SUSE Knowledge Base article #7022937, *Security Vulnerability: Spectre Variant 4 (Speculative Store Bypass) aka CVE-2018-3639*: <https://www.suse.com/support/kb/doc?id=7022937> ↗
- *speed47/spectre-meltdown-checker* source code on GitHub, with detailed references to relevant Common Vulnerabilities and Exposures (CVE): <https://github.com/speed47/spectre-meltdown-checker> ↗
- SUSE Blog article, *Meltdown and Spectre Performance*: <https://www.suse.com/c/meltdown-spectre-performance/> ↗
- SUSE Knowledge Base article #7022512, providing information on architectures, CVEs, and mitigations: <https://www.suse.com/support/kb/doc?id=7022512> ↗

17 Configuring security settings with YaST

The YaST module *Security Center* provides a central control panel for configuring security-related settings for SUSE Linux Enterprise Server. Use it to configure security aspects such as settings for the login procedure and for password creation, for boot permissions, user creation, or for default file permissions. Launch it from the YaST control center with *Security and Users > Security Center*. The *Security Center* dialog opens to the *Security Overview*, with additional configuration dialogs in the left and right panes.

17.1 *Security overview*

The *Security Overview* displays a comprehensive list of the most important security settings for your system. The security status of each entry in the list is visible. A green check mark indicates a secure setting while a red cross indicates an entry as being insecure. Click *Help* to open an overview of the setting and information on how to make it secure. To change a setting, click the corresponding link in the Status column. Depending on the setting, the following entries are available:

Enabled/Disabled

Click this entry to toggle the status of the setting to either enabled or disabled.

Configure

Click this entry to launch another YaST module for configuration. You are returned to the Security Overview when leaving the module.

Unknown

A setting's status is set to unknown when the associated service is not installed. Such a setting does not represent a potential security risk.

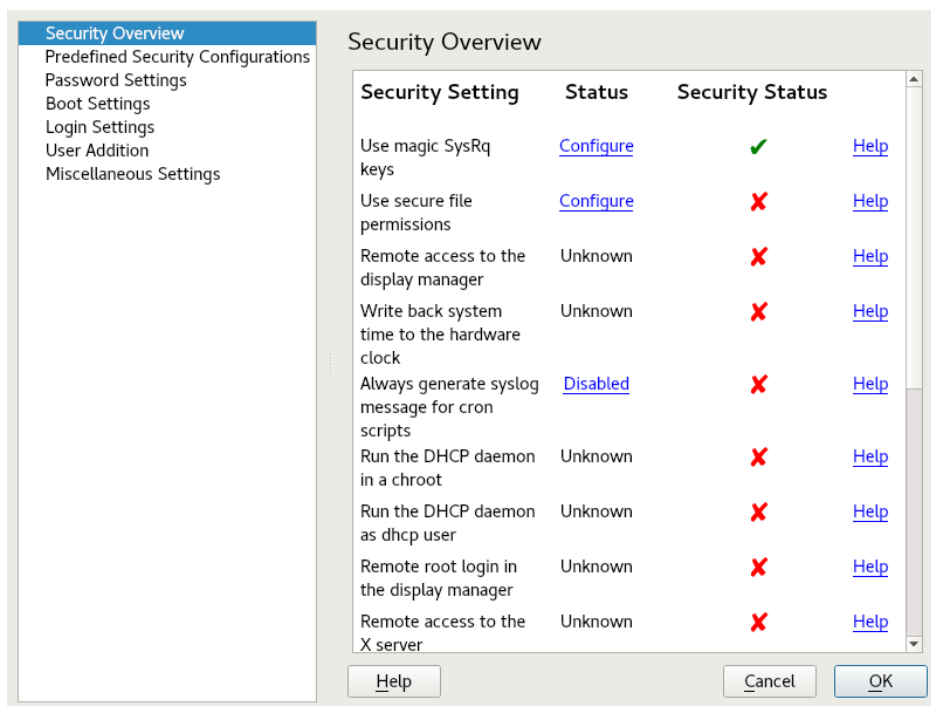

FIGURE 17.1: YAST SECURITY CENTER AND HARDENING: SECURITY OVERVIEW

17.2 Predefined security configurations

SUSE Linux Enterprise Server includes three *Predefined Security Configurations*. These configurations affect all the settings available in the *Security Center* module. Click *Predefined Security Configurations* in the left pane to see the predefined configurations. Click the one you want to apply, then the module closes. If you wish to modify the predefined settings, re-open the *Security Center* module, click *Predefined Security Configurations*, then click *Custom Settings* in the right pane. Any changes you make are applied to your selected predefined configuration.

Workstation

A configuration for a workstation with any kind of network connection (including a connection to the Internet).

Roaming device

This setting is designed for a laptop or tablet that connects to different networks.

Network server

Security settings designed for a machine providing network services such as a Web server, file server, name server, etc. This set provides the most secure configuration of the predefined settings.

Custom settings

Select *Custom Settings* to modify any of the three predefined configurations after they have been applied.

17.3 *Password settings*

Passwords that are easy to guess are a major security issue. The *Password Settings* dialog provides the means to ensure that only secure passwords can be used.

Check new passwords

By activating this option, a warning is issued if new passwords appear in a dictionary, or if they are proper names (proper nouns).

Minimum acceptable password length

If the user chooses a password with a length shorter than specified here, a warning is issued.

Number of passwords to remember

When password expiration is activated (via *Password Age*), this setting stores the given number of a user's previous passwords, preventing their reuse.

Password encryption method

Choose a password encryption algorithm. Normally there is no need to change the default (Blowfish).

Password age

Activate password expiration by specifying a minimum and a maximum time limit (in days). By setting the minimum age to a value greater than 0 days, you can prevent users from immediately changing their passwords again (and in doing so circumventing the password expiration). Use the values 0 and 99999 to deactivate password expiration.

Days before password expires warning

When a password expires, the user receives a warning in advance. Specify the number of days before the expiration date that the warning should be issued.

17.4 *Boot settings*

Configure which users can shut down the machine via the graphical login manager in this dialog. You can also specify how `Ctrl - Alt - Del` is interpreted and who can hibernate the system.

17.5 *Login settings*

This dialog lets you configure security-related login settings:

Delay after incorrect login attempt

To make it difficult to guess a user's password by repeatedly logging in, it is recommended to delay the display of the login prompt that follows an incorrect login. Specify the value in seconds. Make sure that users who have mistyped their passwords do not need to wait too long.

Allow remote graphical login

When checked, the graphical login manager (GDM) can be accessed from the network. This is a potential security risk.

17.6 *User addition*

Set minimum and maximum values for user and group IDs. These default settings would rarely need to be changed.

17.7 *Miscellaneous settings*

Other security settings that do not fit the above-mentioned categories are listed here:

File permissions

SUSE Linux Enterprise Server comes with three predefined sets of file permissions for system files. These permission sets define whether a regular user can read log files or start certain programs. *Easy* file permissions are suitable for stand-alone machines. These settings allow regular users to, for example, read most system files. See the file `/etc/permissions.easy` for the complete configuration. The *Secure* file permissions are designed for multiuser machines with network access. A thorough explanation of these settings can be found in `/etc/permissions.secure`. The *Paranoid* settings are the most restrictive ones and should be used with care. See `/etc/permissions.paranoid` for more information.

User launching updatedb

The program **updatedb** scans the system and creates a database of all files, which can be queried with the command **locate**. When **updatedb** is run as user **nobody**, only world-readable files are added to the database. When run as user **root**, almost all files (except the ones root is not allowed to read) are added.

Enable magic SysRq keys

The magic SysRq key is a key combination that enables you to have certain control over the system even when it has crashed. The complete documentation can be found at <https://www.kernel.org/doc/html/latest/admin-guide/sysrq.html> .

18 The Polkit authentication framework

Polkit is an authentication framework used in graphical Linux desktop environments, for fine-grained management of access rights on the system. Traditionally, there is a strong separation of privileges on Linux between the `root` user as the fully authorized administrator account, and all other accounts and groups on the system. These non-administrator accounts may have certain additional privileges, like accessing sound hardware through an `audio` group. However, this kind of privilege is fixed and cannot be granted in certain specific situations, or for a certain duration of time.

Instead of fully switching to the `root` user (using programs such as `sudo`) for gaining higher privileges, Polkit grants specific privileges to a user or group on an as-needed basis. This is controlled by configuration files that describe individual actions that need to be authorized in a dynamic context.

18.1 Conceptual overview

Polkit consists of multiple components. `polkitd` is a privileged central background service that performs authentication checks based on the existing Polkit configuration. Polkit-enabled applications forward specific authentication requests to the `polkitd` daemon. A Polkit authentication agent running in the unprivileged user context is responsible for displaying authentication requests on behalf of the `polkitd` daemon, and providing the credentials that have been entered interactively by the user.

A Polkit *action* represents a single activity that is subject to Polkit's authorization rules. For example, the intent to reboot the computer can be modeled as a single action in Polkit. Each action has a unique identifier, for the reboot example the action is called `org.freedesktop.login1.reboot`.

18.1.1 The authentication agent

When a user starts a graphical session in a fully featured desktop environment, an authentication agent is typically started automatically, running in the background. You notice it when an authentication prompt appears in response to an application requesting authorization for a certain action. Using Polkit in text mode or via SSH is not easily possible, therefore this document focuses on its use in a graphical session context.

18.1.2 Configuration of Polkit

Polkit's configuration consists of *actions* and *authorization rules*:

Actions (file extension `*.policy`)

Actions are defined in XML files that are located in `/usr/share/polkit-1/actions`. Each file defines one or more actions for a certain application domain, and each action contains human-readable descriptions and its default authorization settings. Although a system administrator can write their own rules, these default policy files must not be edited directly.

Authorization rules (file extension `*.rules`)

Rules are written in the JavaScript programming language, and are located in two places: `/usr/share/polkit-1/rules.d` is used by system packages, and `/etc/polkit-1/rules.d` is for locally administered configurations. The rule files contain more complex logic on top of the default action authorization settings. For example, a rule file could overrule a restrictive action and allow certain users to use it even without authorization.

18.1.3 Polkit Utilities

Polkit provides utilities for specific tasks (see also their respective man pages for further details):

pkaction

Get details about a defined action. See [Section 18.3, "Querying privileges"](#) for more information.

pkcheck

Checks whether a process is authorized for a specific Polkit action.

pkexec

Allows programs to be executed as a different user based on Polkit authorization settings. This is similar to `su` or `sudo`.

pktttyagent

Starts a textual authentication agent. This agent is used if a desktop environment does not have its own authentication agent.

18.2 Authorization types

Every time a Polkit-enabled application carries out a privileged operation, Polkit is asked whether the user is entitled to do so. The answer can be yes, no or authentication needed. In the latter case, an authentication dialog is displayed for the user to enter the necessary credentials.

18.2.1 Implicit authorizations

When no dedicated Polkit JavaScript rules exist for a given action, the outcome depends on the implicit authorizations settings that are defined for each action in a Polkit policy file. There are three authorization categories: allow_active, allow_inactive and allow_any. allow_active is applied to users in an active session. An active session is a local login on the text mode console or in a graphical user environment. The session becomes inactive when you switch to another console, for example, in which case the category allow_inactive is relevant. allow_any is used for all other contexts, for example for remote users logged in via SSH or VNC. Each of these categories has one of the following authorization settings assigned:

no

The user is never granted authorization of the desired action.

yes

The user is always granted authorization without the need to enter any credentials.

auth_self

The user needs to enter their own password for the action to be authorized.

auth_self_keep

Like auth_self, but the authorization is cached for a certain duration, for example, if the same action is executed by the same application again, then it is not necessary to re-enter the password.

auth_admin

The user needs to enter the administrator (root) password for the action to be authorized.

`auth_admin_keep`

Similar to `auth_self_keep`, requiring the administrator (`root`) password.

18.2.2 SUSE default privileges

The implicit authorization settings found in Polkit policy files described so far are from the upstream developers of the respective applications. We call these settings the *upstream defaults*. These upstream defaults are not necessarily the same defaults that are used on SUSE systems. SUSE Linux Enterprise Server comes with a predefined set of privileges that override the upstream defaults. These settings come in three different flavors (profiles) of which only one can be active at any time:

`/etc/polkit-default-privs.easy`

Authorization settings tailored towards single-user desktop systems where the administrator is also the active interactive user. It offers reduced security in favor of improved user experience.

`/etc/polkit-default-privs.standard`

Balanced settings suitable for most systems.

`/etc/polkit-default-privs.restrictive`

More conservative authorization settings that reduce possible attack surface at the expense of user experience in certain areas.

To switch the active polkit profile, edit `/etc/sysconfig/security` and adjust the value of `POLKIT_DEFAULT_PRIVS` to one of `easy`, `standard` or `restrictive`. Then run the command `set_polkit_default_privs` as `root`.

Do not modify the profile settings in the files listed above. To define your own custom Polkit settings, use `/etc/polkit-default-privs.local`. For details, refer to [Section 18.4.3, "Modifying the SUSE default privileges"](#).

18.3 Querying privileges

To query privileges, use the command `pkaction` included in Polkit.

Polkit comes with command-line tools for changing privileges and executing commands as another user (see [Section 18.1.3, “Polkit Utilities”](#) for a short overview). Each existing policy has a unique name with which it can be identified. List all available policies with the command **pkaction**. See **man pkaction** for more information.

To display the needed authorization for a given policy (for example, `org.freedesktop.login1.reboot`), use **pkaction** as follows:

```
> pkaction -v --action-id=org.freedesktop.login1.reboot
org.freedesktop.login1.reboot:
description:      Reboot the system
message:         Authentication is required to allow rebooting the system
vendor:          The systemd Project
vendor_url:      http://www.freedesktop.org/wiki/Software/systemd
icon:
implicit any:    auth_admin_keep
implicit inactive: auth_admin_keep
implicit active:  yes
```



Note: Restrictions of **pkaction** on SUSE Linux Enterprise Server **pkaction** only takes the upstream defaults into account. It is not aware of the SUSE default privileges that are overriding the upstream defaults. Therefore, be careful about interpreting this output.

18.4 Modifying Polkit configuration

Adjusting Polkit settings is useful when you want to deploy the same set of policies to different machines, for example, to the computers of a specific team. Customization of Polkit authorization settings can also be used to harden security for specific actions, or to improve the user experience by reducing the amount of password prompts for frequently used actions. However, granting certain Polkit actions without authentication can be a security hazard that may grant a regular user full `root` privileges. Reduce Polkit authentication requirements when you are certain that this does not violate the system security in your specific environment.

18.4.1 Overriding Polkit policy files

The list of available Polkit actions depends on the packages that you have installed on your system. For a quick overview, use `pkaction` to list all actions Polkit knows about.

For the purposes of this example, we show how the command `gparted` (“GNOME Partition Editor”) is integrated into Polkit.

The file `/usr/share/polkit-1/actions/org.opensuse.policykit.gparted.policy` has the following content:

```
<?xml version="1.0" encoding="UTF-8"?>
<!DOCTYPE policyconfig PUBLIC
"-//freedesktop//DTD PolicyKit Policy Configuration 1.0//EN"
"http://www.freedesktop.org/standards/PolicyKit/1.0/policyconfig.dtd">
<policyconfig> ❶

  <action id="org-opensuse-polkit-gparted"> ❷
    <message>Authentication is required to run the GParted Partition Editor</message>
    <icon_name>gparted</icon_name>
    <defaults> ❸
      <allow_any>auth_admin</allow_any>
      <allow_inactive>auth_admin</allow_inactive>
      <allow_active>auth_admin</allow_active>
    </defaults>
    <annotate ❹
      key="org.freedesktop.policykit.exec.path">/usr/sbin/gparted</annotate>
    <annotate ❹
      key="org.freedesktop.policykit.exec.allow_gui">>true</annotate>
    </action>

</policyconfig>
```

- ❶ Root XML element of the policy file.
- ❷ Start of the definition of the only action in this policy.
- ❸ Here the implicit authorization settings as described above are found.
- ❹ The `annotate` element contains additional information regarding how Polkit performs an action. In this case, it contains the path to the `gparted` executable and a setting that this program is allowed to access the graphical display. These annotations are necessary for the use of an action in conjunction with the Polkit tool `pkexec`.

To add your own policy, create a `.policy` file with the structure above, add the appropriate action name into the `id` attribute, and define the desired override implicit authorization settings.



Note: Deprecated name PolicyKit

The Polkit authorization framework was formerly named PolicyKit. In certain places, like the XML document preamble above, this old name still appears.

18.4.2 Adding JavaScript authorization rules

Authorization rules overrule the implicit authorization settings. To add your own rules, store your files under `/etc/polkit-1/rules.d/`.

The files in this directory start with a two-digit number, a dash, a descriptive name, and end with `.rules`. Functions inside these files are executed in the lexicographical order of the file names in the directory. For example, `00-foo.rules` is ordered (and hence executed) before `60-bar.rules` or even `90-default-privs.rules`.

Inside the rule file, the script typically checks for the action ID to be authorized. For example, to allow the command **gparted** to be executed by any member of the `admin` group, check for the action ID `org.opensuse.policykit.gparted`:

```
/* Allow users in admin group to run GParted without authentication */
polkit.addRule(function(action, subject) {
    if (action.id == "org.opensuse.policykit.gparted" &&
        subject.isInGroup("admin")) {
        return polkit.Result.YES;
    }
});
```

Find the description of all classes and methods of the functions in the Polkit API at <https://www.freedesktop.org/software/polkit/docs/latest/ref-api.html>.

18.4.3 Modifying the SUSE default privileges

As described in [Section 18.2.2, “SUSE default privileges”](#), SUSE ships different override profiles for the Polkit implicit authorization settings defined by the upstream developers. Custom privileges can be defined in `/etc/polkit-default-privs.local`. Privileges defined here always take precedence over the predefined profile settings. To add a custom privilege setting, do the following:

PROCEDURE 18.1: MODIFYING DEFAULT PRIVILEGES

1. Edit `/etc/polkit-default-privs.local`. To define a privilege, add a line for each action in the following format:

```
<action-id>      <auth_any>:<auth_inactive>:<auth_active>
```

Alternatively, if all three categories receive the same value, you can also specify a single value:

```
<action-id>      <auth_all>
```

For example:

```
org.freedesktop.color-manager.modify-profile      auth_admin_keep
```

2. Run this tool as `root` for the changes to take effect:

```
# /sbin/set_polkit_default_privs
```

Refer to `man polkit-default-privs` for the full documentation of the SUSE Polkit default privileges.

18.5 Restoring the SUSE default privileges

To restore the SUSE default authorization settings follow these steps:

PROCEDURE 18.2: RESTORING THE SUSE LINUX ENTERPRISE SERVER DEFAULTS

1. Choose the desired profile as described in [Section 18.2.2, “SUSE default privileges”](#)
2. Remove any overrides from `/etc/polkit-default-privs.local`.
3. Run `set_polkit_default_privs` to regenerate the default rules.

19 Access control lists in Linux

POSIX ACLs (access control lists) can be used as an expansion of the traditional permission concept for file system objects. With ACLs, permissions can be defined more flexibly than with the traditional permission concept.

The term *POSIX ACL* suggests that this is a true POSIX (*portable operating system interface*) standard. The respective draft standards POSIX 1003.1e and POSIX 1003.2c have been withdrawn for several reasons. Nevertheless, ACLs (as found on many systems belonging to the Unix family) are based on these drafts and the implementation of file system ACLs (as described in this chapter) follows these two standards.

19.1 Traditional file permissions

The permissions of all files included in SUSE Linux Enterprise Server are carefully chosen. When installing additional software or files, take great care when setting the permissions. Always use the `-l` option with the command `ls` to detect any incorrect file permissions immediately. An incorrect file attribute does not only mean that files could be changed or deleted. Modified files could be executed by `root` or services could be hijacked by modifying configuration files. This increases the danger of an attack.

A SUSE® Linux Enterprise Server system includes the files `permissions`, `permissions.easy`, `permissions.secure`, and `permissions.paranoid`, all in the directory `/etc`. The purpose of these files is to define special permissions, such as world-writable directories or, for files, the setuser ID bit. Programs with the setuser ID bit set do not run with the permissions of the user that launched it, but with the permissions of the file owner, `root`. An administrator can use the file `/etc/permissions.local` to add their own settings.

To define one of the available profiles, select *Local Security* in the *Security and Users* section of YaST. To learn more about the topic, read the comments in `/etc/permissions` or consult `man chmod`.

Find detailed information about the traditional file permissions in the GNU Coreutils Info page, Node *File permissions* (`info coreutils "File permissions"`). More advanced features are the `setuid`, `setgid` and sticky bit.

19.1.1 The `setuid` bit

In certain situations, the access permissions may be too restrictive. Therefore, Linux has additional settings that enable the temporary change of the current user and group identity for a specific action. For example, the `passwd` program normally requires root permissions to access `/etc/passwd`. This file contains important information, like the home directories of users and user and group IDs. Thus, a normal user would not be able to change `passwd`, because it would be too dangerous to grant all users direct access to this file. A possible solution to this problem is the `setuid` mechanism. `setuid` (set user ID) is a special file attribute that instructs the system to execute programs marked accordingly under a specific user ID. Consider the `passwd` command:

```
-rwsr-xr-x 1 root shadow 80036 2004-10-02 11:08 /usr/bin/passwd
```

You can see the `s` that denotes that the `setuid` bit is set for the user permission. Through the `setuid` bit, all users starting the `passwd` command execute it as `root`.

19.1.2 The `setgid` bit

The `setuid` bit applies to users. However, there is also an equivalent property for groups: the `setgid` bit. A program for which this bit was set runs under the group ID under which it was saved, no matter which user starts it. Therefore, in a directory with the `setgid` bit, all newly created files and subdirectories are assigned to the group to which the directory belongs. Consider the following example directory:

```
drwxrws--- 2 tux archive 48 Nov 19 17:12 backup
```

You can see the `s` that denotes that the `setgid` bit is set for the group permission. The owner of the directory and members of the group `archive` can access this directory. Users that are not members of this group are “mapped” to the respective group. The effective group ID of all written files is `archive`. For example, a backup program that runs with the group ID `archive` can access this directory even without root privileges.

19.1.3 The sticky bit

There is also the *sticky bit*. It makes a difference whether it belongs to an executable program or a directory. If it belongs to a program, a file marked in this way is loaded to RAM to avoid needing to get it from the hard disk each time it is used. This attribute is used rarely, because modern hard disks are fast enough. If this bit is assigned to a directory, it prevents users from deleting each other's files. Typical examples include the `/tmp` and `/var/tmp` directories:

```
drwxrwxrwt 2 root root 1160 2002-11-19 17:15 /tmp
```

19.2 Advantages of ACLs

Traditionally, three permission sets are defined for each file object on a Linux system. These sets include the read (r), write (w), and execute (x) permissions for each of three types of users—the file owner, the group, and other users. Additionally, it is possible to set the *set user id*, the *set group id*, and the *sticky bit*. This lean concept is fully adequate for most practical cases. However, for more complex scenarios or advanced applications, system administrators formerly needed to use several workarounds to circumvent the limitations of the traditional permission concept. ACLs can be used as an extension of the traditional file permission concept. They allow the assignment of permissions to individual users or groups even if these do not correspond to the original owner or the owning group. Access control lists are a feature of the Linux kernel and are currently supported by Ext2, Ext3, Ext4, JFS and XFS. Using ACLs, complex scenarios can be realized without implementing complex permission models on the application level.

The advantages of ACLs are evident if you want to replace a Windows server with a Linux server. Some connected workstations may continue to run under Windows even after the migration. The Linux system offers file and print services to the Windows clients with Samba. With Samba supporting access control lists, user permissions can be configured both on the Linux server and in Windows with a graphical user interface (only Windows NT and later). With `winbindd`, part of the Samba suite, it is even possible to assign permissions to users only existing in the Windows domain without any account on the Linux server.

19.3 Definitions

User class

The conventional POSIX permission concept uses three *classes* of users for assigning permissions in the file system: the owner, the owning group, and other users. Three permission bits can be set for each user class, giving permission to read (r), write (w), and execute (x).

ACL

The user and group access permissions for all kinds of file system objects (files and directories) are determined through ACLs.

Default ACL

Default ACLs can only be applied to directories. They determine the permissions a file system object inherits from its parent directory when it is created.

ACL entry

Each ACL consists of a set of ACL entries. An ACL entry contains a type, a qualifier for the user or group to which the entry refers, and a set of permissions. For certain entry types, the qualifier for the group or users is undefined.

19.4 Handling ACLs

Table 19.1, "ACL entry types" summarizes the six possible types of ACL entries, each defining permissions for a user or a group of users. The *owner* entry defines the permissions of the user owning the file or directory. The *owning group* entry defines the permissions of the file's owning group. The superuser can change the owner or owning group with **chown** or **chgrp**, in which case the owner and owning group entries refer to the new owner and owning group. Each *named user* entry defines the permissions of the user specified in the entry's qualifier field. Each *named group* entry defines the permissions of the group specified in the entry's qualifier field. Only the named user and named group entries have a qualifier field that is not empty. The *other* entry defines the permissions of all other users.

The *mask* entry further limits the permissions granted by named user, named group, and owning group entries by defining which of the permissions in those entries are effective and which are masked. If permissions exist in one of the mentioned entries and in the mask, they are effective. Permissions contained only in the mask or only in the actual entry are not effective—meaning

the permissions are not granted. All permissions defined in the owner and owning group entries are always effective. The example in *Table 19.2, “Masking access permissions”* demonstrates this mechanism.

There are two basic classes of ACLs: A *minimum* ACL contains only the entries for the types owner, owning group, and other, which correspond to the conventional permission bits for files and directories. An *extended* ACL goes beyond this. It must contain a mask entry and may contain several entries of the named user and named group types.

TABLE 19.1: ACL ENTRY TYPES

Type	Text Form
owner	<u>user::rwx</u>
named user	<u>user:name:rwx</u>
owning group	<u>group::rwx</u>
named group	<u>group:name:rwx</u>
mask	<u>mask::rwx</u>
other	<u>other::rwx</u>

TABLE 19.2: MASKING ACCESS PERMISSIONS

Entry Type	Text Form	Permissions
named user	<u>user:geeko:r-x</u>	<u>r-x</u>
mask	<u>mask::rw-</u>	<u>rw-</u>
	effective permissions:	<u>r--</u>

19.4.1 ACL entries and file mode permission bits

Figure 19.1, “Minimum ACL: ACL entries compared to permission bits” and *Figure 19.2, “Extended ACL: ACL entries compared to permission bits”* illustrate the two cases of a minimum ACL and an extended ACL. The figures are structured in three blocks—the left block shows the type specifications of the ACL entries, the center block displays an example ACL, and the right block shows the

respective permission bits according to the conventional permission concept (for example, as displayed by `ls -l`). In both cases, the *owner class* permissions are mapped to the ACL entry owner. *Other class* permissions are mapped to the respective ACL entry. However, the mapping of the *group class* permissions is different in the two cases.



FIGURE 19.1: MINIMUM ACL: ACL ENTRIES COMPARED TO PERMISSION BITS

For a minimum ACL—without mask—the group class permissions are mapped to the ACL entry owning group. This is shown in *Figure 19.1, “Minimum ACL: ACL entries compared to permission bits”*. For an extended ACL—with mask—the group class permissions are mapped to the mask entry. This is shown in *Figure 19.2, “Extended ACL: ACL entries compared to permission bits”*.

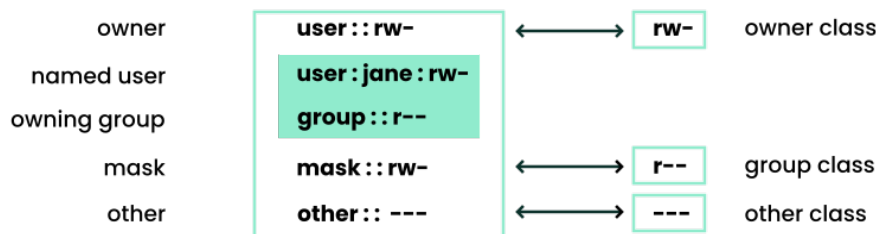

FIGURE 19.2: EXTENDED ACL: ACL ENTRIES COMPARED TO PERMISSION BITS

This mapping approach ensures the smooth interaction of applications, regardless of whether they have ACL support. The access permissions that were assigned through the permission bits represent the upper limit for all other “fine adjustments” made with an ACL. Changes made to the permission bits are reflected by the ACL and vice versa.

19.4.2 A directory with an ACL

With `getfacl` and `setfacl` on the command line, you can access ACLs. The usage of these commands is demonstrated in the following example.

Before creating the directory, use the `umask` command to define which access permissions should be masked each time a file object is created. The command `umask 027` sets the default permissions by giving the owner the full range of permissions (`0`), denying the group write access (`2`), and giving other users no permissions (`7`). `umask` masks the corresponding permission bits or turns them off. For details, refer to *Section 11.4, “Default umask”* or the `umask` man page.

`mkdir mydir` creates the `mydir` directory with the default permissions as set by `umask`. Use `ls -dl mydir` to check whether all permissions were assigned correctly. The output for this example is:

```
drwxr-x--- ... tux project3 ... mydir
```

With `getfacl mydir`, check the initial state of the ACL. This gives information like:

```
# file: mydir
# owner: tux
# group: project3
user::rwx
group::r-x
other::---
```

The first three output lines display the name, owner and owning group of the directory. The next three lines contain the three ACL entries owner, owning group, and other. Specifically for the minimum ACL, the `getfacl` command does not produce any information you could not have obtained with `ls`.

Modify the ACL to assign read, write and execute permissions to an additional user `geeko` and an additional group `mascots` with:

```
# setfacl -m user:geeko:rwx,group:mascots:rwx mydir
```

The option `-m` prompts `setfacl` to modify the existing ACL. The following argument indicates the ACL entries to modify (multiple entries are separated by commas). The final part specifies the name of the directory to which these modifications should be applied. Use the `getfacl` command to take a look at the resulting ACL.

```
# file: mydir
# owner: tux
# group: project3
user::rwx
user:geeko:rwx
group::r-x
group:mascots:rwx
mask::rwx
other::---
```

Besides the entries initiated for the user `geeko` and the group `mascots`, a mask entry has been generated. This mask entry is set automatically so that all permissions are effective. `setfacl` automatically adapts existing mask entries to the settings modified, unless you deactivate this

feature with `-n`. The mask entry defines the maximum effective access permissions for all entries in the group class. This includes named user, named group, and owning group. The group class permission bits displayed by `ls -dl mydir` now correspond to the `mask` entry.

```
drwxrwx---+ ... tux project3 ... mydir
```

The first column of the output contains an additional `+` to indicate that there is an *extended* ACL for this item.

According to the output of the `ls` command, the permissions for the mask entry include write access. Traditionally, such permission bits would mean that the owning group (here `project3`) also has write access to the directory `mydir`.

However, the effective access permissions for the owning group correspond to the overlapping portion of the permissions defined for the owning group and for the mask—which is `r-x` in our example (see [Table 19.2, “Masking access permissions”](#)). As far as the effective permissions of the owning group in this example are concerned, nothing has changed even after the addition of the ACL entries.

Edit the mask entry with `setfacl` or `chmod`. For example, use `chmod g-w mydir`. `ls -dl mydir` then shows:

```
drwxr-x---+ ... tux project3 ... mydir
```

`getfacl mydir` provides the following output:

```
# file: mydir
# owner: tux
# group: project3
user::rwx
user:geeko:rwx          # effective: r-x
group::r-x
group:mascots:rwx      # effective: r-x
mask::r-x
other::---
```

After executing `chmod` to remove the write permission from the group class bits, the output of `ls` is sufficient to see that the mask bits must have changed accordingly: Write permission is again limited to the owner of `mydir`. The output of the `getfacl` confirms this. This output includes a comment for all those entries in which the effective permission bits do not correspond to the original permissions, because they are filtered according to the mask entry. The original permissions can be restored at any time with `chmod g+w mydir`.

19.4.3 A directory with a default ACL

Directories can have a default ACL, which is a special kind of ACL defining the access permissions that objects in the directory inherit when they are created. A default ACL affects both subdirectories and files.

19.4.3.1 Effects of a default ACL

There are two ways in which the permissions of a directory's default ACL are passed to the files and subdirectories:

- A subdirectory inherits the default ACL of the parent directory both as its default ACL and as an ACL.
- A file inherits the default ACL as its ACL.

All system calls that create file system objects use a `mode` parameter that defines the access permissions for the newly created file system object. If the parent directory does not have a default ACL, the permission bits as defined by the `umask` are subtracted from the permissions as passed by the `mode` parameter, with the result being assigned to the new object. If a default ACL exists for the parent directory, the permission bits assigned to the new object correspond to the overlapping portion of the permissions of the `mode` parameter and those that are defined in the default ACL. The `umask` is disregarded in this case.

19.4.3.2 Application of default ACLs

The following three examples show the main operations for directories and default ACLs:

1. Add a default ACL to the existing directory `mydir` with:

```
> setfacl -d -m group:mascots:r-x mydir
```

The option `-d` of the `setfacl` command prompts `setfacl` to perform the following modifications (option `-m`) in the default ACL.

Take a closer look at the result of this command:

```
> getfacl mydir
# file: mydir
```



```
# owner: tux
# group: project3
user::rwx
user:geeko:rwx
group::r-x
group:mascots:rwx
mask::rwx
other::---
default:user::rwx
default:group::r-x
default:group:mascots:r-x
default:mask::r-x
default:other::---
```

getfacl returns both the ACL and the default ACL. The default ACL is formed by all lines that start with `default`. Although you merely executed the **setfacl** command with an entry for the `mascots` group for the default ACL, **setfacl** automatically copied all other entries from the ACL to create a valid default ACL. Default ACLs do not have an immediate effect on access permissions. They only come into play when file system objects are created. These new objects inherit permissions only from the default ACL of their parent directory.

2. In the next example, use **mkdir** to create a subdirectory in `mydir`, which inherits the default ACL.

```
> mkdir mydir/mysubdir

getfacl mydir/mysubdir

# file: mydir/mysubdir
# owner: tux
# group: project3
user::rwx
group::r-x
group:mascots:r-x
mask::r-x
other::---
default:user::rwx
default:group::r-x
default:group:mascots:r-x
default:mask::r-x
default:other::---
```

As expected, the newly created subdirectory `mysubdir` has the permissions from the default ACL of the parent directory. The ACL of `mysubdir` is an exact reflection of the default ACL of `mydir`. The default ACL that this directory hands down to its subordinate objects is also the same.

3. Use `touch` to create a file in the `mydir` directory, for example, `touch mydir/myfile`. `ls -l mydir/myfile` then shows:

```
-rw-r-----+ ... tux project3 ... mydir/myfile
```

The output of `getfacl mydir/myfile` is:

```
# file: mydir/myfile
# owner: tux
# group: project3
user::rw-
group::r-x      # effective:r--
group:mascots:r-x # effective:r--
mask::r--
other::---
```

`touch` uses a `mode` with the value `0666` when creating new files, which means that the files are created with read and write permissions for all user classes, provided no other restrictions exist in `umask` or in the default ACL (see [Section 19.4.3.1, “Effects of a default ACL”](#)). In effect, this means that all access permissions not contained in the `mode` value are removed from the respective ACL entries. Although no permissions were removed from the ACL entry of the group class, the mask entry was modified to mask permissions not set in `mode`.

This approach ensures the smooth interaction of applications (such as compilers) with ACLs. You can create files with restricted access permissions and subsequently mark them as executable. The `mask` mechanism guarantees that the right users and groups can execute them as desired.

19.4.4 The ACL check algorithm

A check algorithm is applied before any process or application is granted access to an ACL-protected file system object. As a basic rule, the ACL entries are examined in the following sequence: owner, named user, owning group or named group, and other. The access is handled in accordance with the entry that best suits the process. Permissions do not accumulate.

Things are more complicated if a process belongs to more than one group and would potentially suit several group entries. An entry is randomly selected from the suitable entries with the required permissions. It is irrelevant which of the entries triggers the final result “access granted”. Likewise, if none of the suitable group entries contain the required permissions, a randomly selected entry triggers the final result “access denied”.

19.5 ACL support in applications

ACLs can be used to implement complex permission scenarios that meet the requirements of modern applications. The traditional permission concept and ACLs can be combined in a smart manner. The basic file commands (`cp`, `mv`, `ls`, etc.) support ACLs, as do Samba and Nautilus. Vi/Vim and emacs both fully support ACLs by preserving the permissions on writing files including backups. Many editors and file managers still lack ACL support. When modifying files with an editor, the ACLs of files are sometimes preserved and sometimes not, depending on the backup mode of the editor used. If the editor writes the changes to the original file, the ACL is preserved. If the editor saves the updated contents to a new file that is subsequently renamed to the old file name, the ACLs may be lost, unless the editor supports ACLs. Except for the `star` archiver, there are currently no backup applications that preserve ACLs.

19.6 More information

For more information about ACLs, see the man pages for `getfacl(1)`, `acl(5)`, and `setfacl(1)`.

20 Intrusion detection with AIDE

Securing your systems is a mandatory task for any mission-critical system administrator. Because it is impossible to always guarantee that the system is not compromised, it is important to do extra checks regularly (for example with `cron`) to ensure that the system is still under your control. This is where AIDE, the *Advanced Intrusion Detection Environment*, comes into play.

20.1 Why use AIDE?

An easy check that often can reveal unwanted changes can be done by means of RPM. The package manager has a built-in verify function that checks all the managed files in the system for changes. To verify all files, run the command `rpm -Va`. However, this command also displays changes in configuration files, and you need to do some filtering to detect important changes.

An additional problem to the method with RPM is that an intelligent attacker can modify `rpm` itself to hide any changes that might have been done by some kind of root-kit, which allows the attacker to mask the intrusion and gain root privilege. To solve this, you should implement a secondary check that can also be run independent of the installed system.

20.2 Setting up an AIDE database



Important: Initialize AIDE database after installation

Before you install your system, verify the checksum of your medium (see *Book "Deployment Guide", Chapter 13 "Troubleshooting", Section 13.1 "Checking media"*) to make sure you do not use a compromised source. After you have installed the system, initialize the AIDE database. To make sure that all went well during and after the installation, do an installation directly on the console, without any network attached to the computer. Do not leave the computer unattended or connected to any network before AIDE creates its database.

AIDE is not installed by default on SUSE Linux Enterprise Server. To install it, either use *Computer > Install Software*, or enter `zypper install aide` on the command line as `root`.

To tell AIDE which attributes of which files should be checked, use the `/etc/aide.conf` configuration file. It must be modified to become the actual configuration. The first section handles general parameters like the location of the AIDE database file. More relevant for local configurations are the `Custom Rules` and the `Directories and Files` sections. A typical rule looks like the following:

```
Binlib      = p+i+n+u+g+s+b+m+c+md5+sha1
```

After defining the variable `Binlib`, the respective check boxes are used in the files section. Important options include the following:

TABLE 20.1: IMPORTANT AIDE CHECK BOXES

Option	Description
p	Check for the file permissions of the selected files or directories.
i	Check for the inode number. Every file name has a unique inode number that should not change.
n	Check for the number of links pointing to the relevant file.
u	Check if the owner of the file has changed.
g	Check if the group of the file has changed.
s	Check if the file size has changed.
b	Check if the block count used by the file has changed.
m	Check if the modification time of the file has changed.
c	Check if the files access time has changed.
S	Check for a changed file size.

Option	Description
I	Ignore changes of the file name.
md5	Check if the md5 checksum of the file has changed. We recommend to use sha256 or sha512.
sha1	Check if the sha1 (160 Bit) checksum of the file has changed. We recommend to use sha256 or sha512.
sha256	Check if the sha256 checksum of the file has changed.
sha512	Check if the sha512 checksum of the file has changed.

This is a configuration that checks for all files in `/sbin` with the options defined in `Binlib` but omits the `/sbin/conf.d/` directory:

```
/sbin Binlib
!/sbin/conf.d
```

To create the AIDE database, proceed as follows:

1. Open `/etc/aide.conf`.
2. Define which files should be checked with which check boxes. For a complete list of available check boxes, see `/usr/share/doc/packages/aide/manual.html`. The definition of the file selection needs certain knowledge about regular expressions. Save your modifications.
3. To check whether the configuration file is valid, run:

```
# aide --config-check
```

Any output of this command is a hint that the configuration is not valid. For example, if you get the following output:

```
# aide --config-check
```

```
35:syntax error:!  
35:Error while reading configuration:!  
Configuration error
```

The error is to be expected in line 36 of `/etc/aide.conf`. The error message contains the last successfully read line of the configuration file.

4. Initialize the AIDE database. Run the command:

```
# aide -i
```

5. Copy the generated database to a save location like a CD-R or DVD-R, a remote server or a flash disk for later use.



Important

This step is essential as it avoids compromising your database. It is recommended to use a medium which can be written once to prevent the database being modified. *Never* leave the database on the computer which you want to monitor.

20.3 Local AIDE checks

To perform a file system check, proceed as follows:

1. Rename the database:

```
# mv /var/lib/aide/aide.db.new /var/lib/aide/aide.db
```

2. After any configuration change, you always need to re-initialize the AIDE database and subsequently move the newly generated database. It is also a good idea to make a backup of this database. See [Section 20.2, "Setting up an AIDE database"](#) for more information.
3. Perform the check with the following command:

```
# aide --check
```

If the output is empty, everything is fine. If AIDE found changes, it displays a summary of changes, for example:

```
# aide --check  
AIDE found differences between database and file system!!
```

```
Summary:
  Total number of files:      1992
  Added files:                0
  Removed files:              0
  Changed files:              1
```

To learn about the actual changes, increase the verbose level of the check with the parameter `-V`. For the previous example, this could look like the following:

```
# aide --check -V
AIDE found differences between database and file system!!
Start timestamp: 2009-02-18 15:14:10

Summary:
  Total number of files:      1992
  Added files:                0
  Removed files:              0
  Changed files:              1

-----
Changed files:
-----

changed: /etc/passwd

-----
Detailed information about changes:
-----

File: /etc/passwd
  Mtime   : 2009-02-18 15:11:02           , 2009-02-18 15:11:47
  Ctime   : 2009-02-18 15:11:02           , 2009-02-18 15:11:47
```

In this example, the file `/etc/passwd` was touched to demonstrate the effect.

20.4 System independent checking

To avoid risk, it is advisable to also run the AIDE binary from a trusted source. This excludes the risk that attackers also modified the aide binary to hide its traces.

To accomplish this task, AIDE must be run from a rescue system that is independent of the installed system. With SUSE Linux Enterprise Server it is easy to extend the rescue system with arbitrary programs, and thus add the needed functionality.

Before you can start using the rescue system, you need to provide two packages to the system. These are included with the same syntax as you would add a driver update disk to the system. For a detailed description about the possibilities of `linuxrc` that are used for this purpose, see <https://en.opensuse.org/SDB:Linuxrc>. In the following, one possible way to accomplish this task is discussed.

PROCEDURE 20.1: STARTING A RESCUE SYSTEM WITH AIDE

1. Provide an FTP server as a second machine.
2. Copy the packages `aide` and `mhash` to the FTP server directory, in our case `/srv/ftp/`. Replace the placeholders `ARCH` and `VERSION` with the corresponding values:

```
# cp DVD1/suse/ARCH/aideVERSION.ARCH.rpm /srv/ftp
# cp DVD1/suse/ARCH/mhashVERSION.ARCH.rpm /srv/ftp
```

3. Create an info file `/srv/ftp/info.txt` that provides the needed boot parameters for the rescue system:

```
dud:ftp://ftp.example.com/aideVERSION.ARCH.rpm
dud:ftp://ftp.example.com/mhashVERSION.ARCH.rpm
```

Replace your FTP domain name, `VERSION` and `ARCH` with the values used on your system.

4. Restart the server that needs to go through an AIDE check with the Rescue system from your DVD. Add the following string to the boot parameters:

```
info=ftp://ftp.example.com/info.txt
```

This parameter tells `linuxrc` to also read in all information from the `info.txt` file.

After the rescue system has booted, the AIDE program is ready for use.

20.5 More information

Information about AIDE is available at the following places:

- The home page of AIDE: <https://aide.github.io/>
- In the documented template configuration `/etc/aide.conf`.

- In several files below [/usr/share/doc/packages/aide](#) after installing the [aide](#) package.
- On the AIDE user mailing list at <https://www.ipi.fi/mailman/listinfo/aide> ↗.

III Network security

- 21 X Window System and X authentication 234
- 22 Securing network operations with OpenSSH 235
- 23 Masquerading and firewalls 264
- 24 Configuring a VPN server 285
- 25 Managing a PKI with XCA, X certificate and key manager 298
- 26 Improving network security with **sysctl** variables 302

21 X Window System and X authentication

Network transparency is one of the central characteristics of a Unix system. X, the windowing system of Unix operating systems, can use this feature in an impressive way. With X, it is no problem to log in to a remote host and start a graphical program that is then sent over the network to be displayed on your computer.

When an X client needs to be displayed remotely using an X server, the latter should protect the resource managed by it (the display) from unauthorized access. In more concrete terms, certain permissions must be given to the client program. With the X Window System, there are two ways to do this, called host-based access control and cookie-based access control. The former relies on the IP address of the host where the client should run. The program to control this is `xhost`. `xhost` enters the IP address of a legitimate client into a database belonging to the X server. However, relying on IP addresses for authentication is not secure. For example, if there were a second user working on the host sending the client program, that user would have access to the X server as well—like someone spoofing the IP address. Because of these shortcomings, this authentication method is not described in more detail here, but you can learn about it with `man xhost`.

For cookie-based access control, a character string is generated that is only known to the X server and to the legitimate user, like an ID card. This cookie is stored on login in the file `~/.Xauthority` in the user's home directory and is available to any X client wanting to use the X server to display a window. The file `~/.Xauthority` can be examined by the user with the tool `xauth`. If you rename `~/.Xauthority`, or if you delete the file from your home directory by accident, you cannot open any new windows or X clients.

SSH (secure shell) can be used to encrypt a network connection and forward it to an X server transparently. This is also called X forwarding. X forwarding is achieved by simulating an X server on the server side and setting a `DISPLAY` variable for the shell on the remote host. Further details about SSH can be found in [Chapter 22, Securing network operations with OpenSSH](#).



Warning: X forwarding can be insecure

If you do not consider the computer where you log in to be a secure host, do not use X forwarding. If X forwarding is enabled, an attacker could authenticate via your SSH connection. The attacker could then intrude on your X server and, for example, read your keyboard input.

22 Securing network operations with OpenSSH

OpenSSH is the SSH (secure shell) implementation that ships with SUSE Linux Enterprise Server, for securing network operations such as remote administration, file transfers, and tunneling insecure protocols. SSH encrypts all traffic between two hosts, including authentication, to protect against eavesdropping and connection hijacking. This chapter covers basic operations, plus host key rotation and certificate authentication, which are useful for managing larger SSH deployments.

22.1 OpenSSH overview

SSH is a network protocol that provides end-to-end protection for communications between the computers on your network, or between computers on your network and systems outside your network. You may open an SSH session to any other computer, if you have a login and the correct authentication methods for the remote computer.

SSH is a client-server protocol. Any host running the `sshd` daemon can accept SSH connections from any other host. Every host running `sshd` can have their own custom configurations, such as limiting who can have access, and which authentication methods are allowed.

Authentication and encryption are provided by encryption key pairs. Each key pair has a public key and a private key. Public keys encrypt, and private keys decrypt. Public keys are meant to be freely shared, while private keys must be protected and not shared. When a private key is compromised, anyone who has possession of it can masquerade as the original key owner.

SSH provides strong protection, because the server and client must both authenticate to each other. When a client first attempts to open an SSH session, the server presents its public host key. If the client already possesses a copy of this key (stored in `~/.ssh/known_hosts` on the client machine), the client knows to trust the server. If the client does not have the appropriate host key, it is asked whether it should trust the server:

```
The authenticity of host '192.168.22.219 (192.168.22.219)'  
can't be established. ECDSA key fingerprint is  
SHA256:yXf6pjV26N0fegvEYIt3HgG95s3Q1X6WYRhtHLF99pUo.  
Are you sure you want to continue connecting (yes/no/[fingerprint])?
```

The user can type `yes` or `no`, or paste their copy of the host key fingerprint for comparison.



Note: Matching host key fingerprints

Distributing copies of your host key fingerprints to your users enables them to verify that they are receiving the correct host keys. When they paste their copy of a host key fingerprint, `ssh` compares the fingerprints, and accepts the offered host key when the fingerprints match. This ensures a more accurate match than a visual comparison.

You cannot rely on users to use correct verification methods. If the fingerprints do not match, the user can still type `yes`, or copy the fingerprint in the message, and complete the connection. A stronger alternative is to use certificate authentication, which provides a global authentication mechanism, and does not require perfect behavior from users (see [Section 22.8, “OpenSSH certificate authentication”](#)).

If the public keys of a host have changed, the connection is denied with an alarming warning:

```
@@@@@@@@@@@@@@@@@@@@@@@@@@@@@@@@@@@@@@@@@@@@@@@@@@@@@@@@@@@@@@@@@@@@@@@@@@@@@@@@@@@@
@   WARNING: REMOTE HOST IDENTIFICATION HAS CHANGED!   @
@@@@@@@@@@@@@@@@@@@@@@@@@@@@@@@@@@@@@@@@@@@@@@@@@@@@@@@@@@@@@@@@@@@@@@@@@@@@@@@@@@@@
IT IS POSSIBLE THAT SOMEONE IS DOING SOMETHING NASTY!
Someone could be eavesdropping on you right now (man-in-the-middle attack)!
It is also possible that a host key has just been changed.
The fingerprint for the ECDSA key sent by the remote host is
SHA256:keNu/rJFWmpQu9B0SjIuo8NLjbeDY/x3Tktpl7oDJqo.
Please contact your system administrator.
Add correct host key in /home/geeko/.ssh/known_hosts to get rid of this message.
Offending ECDSA key in /home/geeko/.ssh/known_hosts:210
You can use following command to remove the offending key:
ssh-keygen -R 192.168.121.219 -f /home/geeko/.ssh/known_hosts
ECDSA host key for 192.168.121.219 has changed and you have requested strict
checking.
Host key verification failed.
```

The remedy is to delete the offending key from `~/.ssh/known_hosts` with the command given in the warning, then reconnect and accept the new host key.

The `openssh` package installs the server, client, file transfer commands, and certain utilities.

OpenSSH supports several different types of authentication:

Password authentication

Uses any system login and password on the remote machine. This is the simplest and most flexible authentication because you can open an SSH session from anywhere, on any machine. It is also the least secure, because it is vulnerable to password-cracking and keystroke logging.

Public key authentication

Authenticates with your personal SSH keys, rather than a login and password. This is less flexible than password authentication, because you can open SSH sessions only from a machine that holds your private identity key. It is much stronger because it is not vulnerable to password cracking or keystroke logging; an attacker must possess your private key and know its passphrase.

See [Section 22.9, “Automated public key logins with gnome-keyring”](#) to learn how to use [gnome-keyring](#) for automated public key authentication in GNOME sessions.

See [Section 22.10, “Automated public key logins with ssh-agent”](#) to learn how to use [ssh-agent](#) for automated public key authentication in console sessions.

Passphrase-less public key authentication

Public key authentication, paired with private identity keys that do not have passphrases. This is useful for automated services, like scripts and cron jobs. You must protect private keys, because anyone who gains access to them can easily masquerade as the key owner.

Certificate authentication

OpenSSH supports certification authentication, for easier key management, stronger authentication, and large-scale SSH deployments.

SUSE Linux Enterprise Server installs the OpenSSH package by default, providing the following commands:

ssh

The client command for initiating an SSH connection to a remote host.

scp

Secure file copy from or to a remote host.

sftp

Secure file transfer between a client and an SFTP server. (The SFTP protocol (SSH FTP) is not related to FTPS or FTPES (FTP over SSL/TLS), but was written independently.)

ssh-add

Add private key identities to the authentication agent, [ssh-agent](#).

ssh-agent

Manages a user's private identity keys and their passphrases, for public key authentication. [ssh-agent](#) holds the passphrases in memory and applies them as needed, so that users do not have to re-type their passphrases to authenticate.

ssh-copy-id

Securely transfer a public key to a remote host, to set up public key authentication.

22.2 Server hardening

OpenSSH ships with a usable default server configuration, but there are additional steps you can take to secure your server.



Important: Maintaining access to a remote SSH server

When you make changes to any SSH server, either have physical access to the machine, or keep an active root SSH session open until you have tested your changes, and everything works correctly. Then you can revert or correct your changes if something goes wrong.

The default server configuration file, `/etc/ssh/sshd_config`, contains the default configuration, and all the defaults are commented out. Override any default item by entering your own configuration item, uncommented, like the following example that sets a different listening port, and specifies the listening IPv4 address on a multi-homed host:

```
#Port 22
Port 2022

#ListenAddress 0.0.0.0
ListenAddress 192.168.10.100
```



Important: Update `/etc/services`

When you use non-standard listening ports, first check the `/etc/services` file for unused ports. Select any unused port above 1024. Then document the ports you are using in `/etc/services`.

It is a best practice to disallow root logins. Instead, log into the remote machine as an unprivileged user, then use `sudo` to run commands as root. If you really want to allow root logins, the following server configuration example shows how to configure the server to accept only public-key authentication ([Section 22.6, “Public key authentication”](#)) for the root user with the `PermitRootLogin prohibit-password` and `PasswordAuthentication` options.

The following settings for `/etc/ssh/sshd_config` strengthen access controls:

EXAMPLE 22.1: `EXAMPLE_SSHD_CONFIG`

```
# Check if the file modes and ownership of the user's files and
# home directory are correct before allowing them to login
StrictModes yes

# If your machine has more than one IP address, define which address or
# addresses it listens on
ListenAddress 192.168.10.100

# Allow only members of the listed groups to log in
AllowGroups ldapadmins backupadmins

# Or, deny certain groups. If you use both, DenyGroups is read first
DenyGroups users

# Allow or deny certain users. If you use both, DenyUsers is read first
AllowUsers user1 user2@example.com user3
DenyUsers user4 user5@192.168.10.10

# Allow root logins only with public key authentication
PermitRootLogin prohibit-password

# Disable password authentication and allow only public key authentication
# for all users
PasswordAuthentication no

# Length of time the server waits for a user to log in and complete the
# connection. The default is 120 seconds:
LoginGraceTime 60

# Limit the number of failed connection attempts. The default is 6
MaxAuthTries 4
```

After changing `/etc/ssh/sshd_config`, run the syntax checker:

```
> sudo sshd -t
```

The syntax checker only checks for correct syntax, and does not find configuration errors. When you are finished, reload the configuration:

```
> sudo systemctl reload sshd.service
```

Check the server's key directories for correct permissions.

`/etc/ssh` should be mode `0755/drwxr-xr-x`, owned by `root:root`.

Private keys should be `0600/-rw-----`, owned by `root:root`.

Public keys should be `0644/-rw-r--r--`, owned by `root:root`.

22.3 Password authentication

With password authentication, all you need is the login and password of a user on the remote machine, and `sshd` set up and running on the remote machine. You do not need any personal SSH keys. In the following example, user `suzanne` opens an SSH session to the host `sun`:

```
> ssh suzanne@sun
```

`suzanne` is prompted to enter the remote password. Type `exit` and press `Enter` to close an SSH session.

If the user name is the same on both machines, you can omit it, and then using `ssh HOST_NAME` is sufficient. After a successful authentication, you can work on the command line or use interactive applications, such as YaST in text mode.

You may also run non-interactive commands (log in, run the command, then the session closes all in one command) on remote systems using the `ssh USER_NAME HOST COMMAND` syntax. `COMMAND` must be properly quoted. Multiple commands can be concatenated as on a local shell:

```
> ssh suzanne@sun "df -h && du -sh /home"
> ssh suzanne@sun "sudo nano /etc/ssh/sshd_config"
```

When you run `sudo` on the remote machine, you are prompted for the `sudo` password.

22.4 Managing user and host encryption keys

There are several key types to choose from: DSA, RSA, ECDSA, ECDSA-SK, Ed25519, and Ed25519-SK. DSA was deprecated several years ago, and was disabled in OpenSSH 7.0 and should not be used. RSA is the most universal as it is older, and more widely used. (As of OpenSSH 8.2, RSA is deprecated for host keys. Use ECDSA or Ed25519 for host keys.)

Ed25519 and ECDSA are stronger and faster. Ed25519 is considered to be the strongest. If you must support older clients that do not support Ed25519 or ECDSA, create host keys in all three formats.



Note: Older clients are unsafe

Some older SSH clients do not support ECDSA and ED25519. ECDSA and ED25519 were released with OpenSSH 6.5 in 2014. It is important to keep security services updated, and, if possible, to not allow unsafe old clients.

SSH keys serve two purposes: authenticating servers to clients, and authenticating clients to servers (see [Section 22.6, “Public key authentication”](#)). Server host keys are stored in `/etc/ssh`. Users' personal keys are stored in `/home/user/.ssh`.

`/home/user/.ssh` is created when the user creates a new SSH key.

Host keys must not have passphrases.

In most cases, private user keys should have strong passphrases.

22.4.1 Creating user SSH key pairs

The following procedure shows how to create user OpenSSH encryption keys.

1. To generate a user key pair with the default parameters (RSA, 3072 bits), use the `ssh-keygen` command with no options. Protect your private key with a strong passphrase:

```
> ssh-keygen
Generating public/private rsa key pair.
Enter file in which to save the key (/home/tux/.ssh/id_rsa):
Enter passphrase (empty for no passphrase):
Enter same passphrase again:
Your identification has been saved in id_rsa
Your public key has been saved in id_rsa.pub
The key fingerprint is:
SHA256:z0uJIuc7Doy07bFTe1ppZHLVrkD/bWwLBAF/PcHjblU user@host2
The key's randomart image is:
+---[RSA 3072]-----+
|           ..0... |
|           o . +E|
|           . . o +.=|
|           . o . o o+|
|           . . S . . o +|
|           . = . = * + . = |
|           o *.o.= * . + |
|           ..Bo+.. . . |
|           oo== .      |
+-----[SHA256]-----+
```

2. Create an RSA key pair with a longer bit length:

```
> ssh-keygen -b 4096
```

OpenSSH RSA keys can be a maximum of 16,384 bits. However, longer bit lengths are not necessarily more desirable. See the GnuPG FAQ for more information, https://www.gnupg.org/faq/gnupg-faq.html#no_default_of_rsa4096.

3. You may create as many user keys as you want, for accessing different servers. Each key pair must have a unique name, and optionally, a comment. These help you remember what each key pair is for. Create an RSA key pair with a custom name and a comment:

```
> ssh-keygen -f backup-server-key -C "infrastructure backup server"
```

4. Create an Ed25519 key pair with a custom name and a comment:

```
> ssh-keygen -t ed25519 -f ldap-server-key -C "Internal LDAP server"
```

Ed25519 keys are fixed at 256 bits, which is equivalent in cryptographic strength to RSA 4096.

22.4.2 Creating SSH server host keys

Host keys are managed a little differently. A host key must not have a passphrase, and the key pairs are stored in `/etc/ssh`. OpenSSH automatically generates a set of host keys when it is installed, like the following example:

```
> ls -l /etc/ssh
total 608
-rw----- 1 root root 577834 2021-05-06 04:48 moduli
-rw-r--r-- 1 root root  2403 2021-05-06 04:48 ssh_config
-rw-r----- 1 root root  3420 2021-05-06 04:48 sshd_config
-rw----- 1 root root  1381 2022-02-10 06:55 ssh_host_dsa_key
-rw-r--r-- 1 root root   604 2022-02-10 06:55 ssh_host_dsa_key.pub
-rw----- 1 root root   505 2022-02-10 06:55 ssh_host_ecdsa_key
-rw-r--r-- 1 root root   176 2022-02-10 06:55 ssh_host_ecdsa_key.pub
-rw----- 1 root root   411 2022-02-10 06:55 ssh_host_ed25519_key
-rw-r--r-- 1 root root    96 2022-02-10 06:55 ssh_host_ed25519_key.pub
-rw----- 1 root root  2602 2022-02-10 06:55 ssh_host_rsa_key
-rw-r--r-- 1 root root   568 2022-02-10 06:55 ssh_host_rsa_key.pub
```

`ssh-keygen` has a special option, `-A`, for creating new host keys. This creates new keys for each of the key types for which host keys do not exist, with the default key file path, an empty passphrase, default bit size for the key type, and an empty comment. The following example creates a complete new set of host keys by first deleting the existing keys, then creating a new set:

```
> sudo rm /etc/ssh/ssh_host*
> sudo ssh-keygen -A
```

You can replace selected key pairs by first deleting only the keys you want to replace, because `ssh-keygen -A` does not replace existing keys.



Important: Do not use DSA keys

`ssh-keygen -A` creates DSA keys, even though they have been deprecated as unsafe for several years. In OpenSSH 7.0 they are still created, but disabled by not being listed in `sshd_config`. You may safely delete DSA keys.

When you want to rotate host keys (see [Section 22.5, “Rotating host keys”](#)), you must create the new keys individually, because they must exist at the same time as your old host keys. Your users authenticate with the old keys, and then receive the list of new keys. They need unique names, to not conflict with the old keys. The following example creates new RSA and Ed25519 host keys, labeled with the year and month they were created. Remember, the new host keys must not have passphrases:

```
> cd /etc/ssh
> sudo ssh-keygen -b 4096 -f "SSH_HOST_RSA_2022_02"
> sudo ssh-keygen -t ed25519 -f "SSH_HOST_ED25519_2022_02"
```

You may name your new keys whatever you want.

22.5 Rotating host keys

As of version 6.8, OpenSSH includes a protocol extension that supports host key rotation. SSH server admins must periodically retire old host keys and create new keys, for example if a key has been compromised, or it is time to upgrade to stronger keys. Before OpenSSH 6.8, if `StrictHostKeyChecking` was set to `yes` in `ssh_config` on user machines, users would see a warning that the host key had changed, and were not allowed to connect. Then the users would have to manually delete the server's public key from their `known_hosts` file, reconnect and manually accept the new key. Any automated SSH connections, such as scheduled backups, would fail.

The new host key rotation scheme provides a method to distribute new keys without service interruptions. When clients connect, the server sends them a list of new keys. Then the next time they log in they are asked if they wish to accept the changes. Give users a few days to connect and receive the new keys, and then you can remove the old keys. The users' `known_hosts` files are automatically updated, with new keys added and the old keys removed.

Setting up host key rotations requires creating new keys on the server, certain changes to `/etc/ssh/sshd_config` on the server, and to `/etc/ssh/ssh_config` on the clients.

First, create your new key or keys. The following example creates a new RSA key and a new Ed25519 key, with unique names and comments. A useful convention is to name them with the creation date. Remember, a host key must not have a passphrase:

```
# ssh-keygen -t rsa -f ssh_host_rsa_2022-01 -C "main server"
Generating public/private rsa key pair.
Enter passphrase (empty for no passphrase):
Enter same passphrase again:
Your identification has been saved in ssh_host_rsa_2022-01
```

```

Your public key has been saved in ssh_host_rsa_2022-01.pub
The key fingerprint is:
SHA256:F1FIF2aq0z7D3mGdsjzHpH/kjUWZehBN3uG7FM4taAQ main server
The key's randomart image is:
+---[RSA 3072]----+
|      .Eo*.oo |
|      .B .o.o|
|      o . .++|
|      . o 000=|
|      S . o +*.|
|      o o.0000|
|      .o ++00.= |
|      .+=0+0 + .|
|      .00++.. |
+-----[SHA256]-----+

# ssh-keygen -t ed25519 -f ssh_host_ed25519_2022-01 -C "main server"
Generating public/private ed25519 key pair.
Enter passphrase (empty for no passphrase):
Enter same passphrase again:
Your identification has been saved in ssh_host_ed25519_2022-01
Your public key has been saved in ssh_host_ed25519_2022-01.pub
The key fingerprint is:
SHA256:2p9K0giXv7WsRnLjwjs4hJ8EFcoX1FWR4nQz6fxnjxg main server
The key's randomart image is:
+--[ED25519 256]--+
|  .+0 ...0+   |
|  . .... o *   |
|  o.. o = o    |
|  .. .. o     |
|  o. o S .    |
|  . oo.*+   E o |
|  + ++==.. = o |
|  = +00= o. . .|
|  ..+=0=     |
+-----[SHA256]-----+

```

Record the fingerprints, for users to verify the new keys.

Add the new key names to `/etc/ssh/sshd_config`, and uncomment any existing keys that are in use:

```

## Old keys
HostKey /etc/ssh/ssh_host_rsa_key
HostKey /etc/ssh/ssh_host_ed25519_key
HostKey /etc/ssh/ssh_host_ecdsa_key

## New replacement keys

```

```
HostKey /etc/ssh/ssh_host_rsa_2022-01
HostKey /etc/ssh/ssh_host_ed25519_2022-01
```

Save your changes, then restart `sshd`:

```
# systemctl restart sshd.service
```

The `/etc/ssh/ssh_config` file on user machines must include the following settings:

```
UpdateHostKeys ask
StrictHostKeyChecking yes
```

Test connecting from a client by opening an SSH session to the server to receive the new keys list. Log out, then log back in. When you log back in you should see something like the following message:

```
The server has updated its host keys.
These changes were verified by the server's existing trusted key.
Deprecating obsolete hostkey: ED25519
SHA256:V28d3VpHgjsCoV04RBCZpLo5c0kEsLCZDVdIUnCvqPI
Deprecating obsolete hostkey:
RSA SHA256:+NR4DVdbsUNsqJPIhISzx+eqD4x/awCCwijZ4a9eP8I
Accept updated hostkeys? (yes/no):yes
```

You may set `UpdateHostKeys ask` to `UpdateHostKeys yes` to apply the changes automatically, and avoid asking users to approve the changes.

For more information:

- [Section 22.4, “Managing user and host encryption keys”](#)
- <http://blog.djm.net.au/2015/02/key-rotation-in-openssh-68.html> ↗
- `man 5 ssh_config`, `man 5 sshd_config`

22.6 Public key authentication

Public key authentication uses your own personal identity key to authenticate, rather than a user account password.

The following example shows how to create a new personal RSA key pair with a comment, so you know what it is for. First change to your `~/.ssh` directory (or create it if it does not exist), then create the new key pair. Give it a strong passphrase, and write the passphrase in a safe place:

```
> cd ~/.ssh
```



```
> ssh-keygen -C "web server1" -f id-web1 -t rsa -b 4096
```

Next, copy your new public key to the machine you want access to. You must already have a user account on this machine, and SSH access to copy it over the network:

```
> ssh-copy-id -i id-web1 user@web1
```

Then try logging in with your new key:

```
> ssh -i id-web1 user@web1
Enter passphrase for key 'id-web1':
Last login: Sat Jul 11 11:09:53 2022 from 192.168.10.122
Have a lot of fun...
```

You should be asked for your private key passphrase, and not the password for your user account. To be effective, public key authentication should be enforced on the remote machine, and password authentication not allowed (see [Example 22.1, “Example sshd_config”](#)). If you do not have public key authentication access on the remote machine already, you cannot copy your new public key with `ssh-copy-id`, and must use other means, such as manually copying it from a USB stick to the `~/.ssh/authorized_keys` file of the remote user account.

22.7 Passphrase-less public key authentication

This is public key authentication without a passphrase. Create your new private identity keys without a passphrase, and then use them the same way as passphrase-protected keys. This is useful for automated services, such as scripts and cron jobs. However, anyone who succeeds in stealing the private key can easily masquerade as you, so you need to be protective of a passphrase-less private key.

An alternative to using keys without passphrases is `gnome-keyring`, which remembers and applies your private keys and passphrases for you. `gnome-keyring` is for GNOME desktop sessions ([Section 22.9, “Automated public key logins with gnome-keyring”](#)).

For console sessions, use `ssh-agent` ([Section 22.10, “Automated public key logins with ssh-agent”](#)).

22.8 OpenSSH certificate authentication

OpenSSH introduced certificate authentication in OpenSSH 5.4. Certificate authentication is similar to public key authentication, except hosts and users authenticate to each other with digitally signed encryption certificates instead of encryption keys. Certificate authentication pro-

vides central management for server and user certificates, eliminating the need to manually copy user public keys to multiple hosts. It increases security by giving more control to administrators, and less to users.

Certificates consist of a public encryption key, a user-defined identity string, zero or more user names or host names, and other options. User and host public keys are signed by a Certificate Authority (CA) private signing key to create an encryption certificate. Users and hosts trust the public CA key, rather than trusting individual user and host public encryption keys.

Traditional OpenSSH public key authentication requires copying user public keys to every SSH server they need access to (to the appropriate `~/.ssh/authorized_keys` files), and relying on users to verify new SSH server host keys before accepting them (stored in `~/.ssh/known_hosts`). This is error-prone and complicated to manage. Another disadvantage is OpenSSH keys never expire. When you need to revoke a particular public key, you have to find and remove all its copies on your network.

Automating the whole process (for example, with Ansible) is virtually a necessity. Large organizations, such as Meta (see <https://engineering.fb.com/2016/09/12/security/scalable-and-secure-access-with-ssh/>), automate the process completely, so they can revoke and replace certificates, and even certificate authorities, as often as they want without disrupting operations.

A prerequisite is the ability to open SSH sessions to all hosts on your network, and perform tasks like editing configuration files and restarting `sshd`.

Setting up an OpenSSH certificate authority involves the following steps:

- Set up a secure trusted server to host your certificate authority, for signing host and user keys. Create a new key pair for signing keys. The private key signs user and host keys, and the public key is copied to all users who are allowed access to the server.
- Receive and sign host public keys, then distribute the new host certificates to their respective hosts. Host certificates go in `/etc/ssh`, just like host keys.
- Receive and sign user public keys, then distribute the new user certificates to their owners. User certificates go in `~/.ssh`, just like user keys.
- Edit configuration files on servers and users' machines, and stop and start `sshd` on hosts as necessary.
- Revoke certificates as needed, for example when you suspect a certificate has been compromised, a user has left your organization, or a server has been retired. Revoking a certificate is considerably simpler than finding and removing all relevant public key copies.

Users and server admins create and protect their own OpenSSH keys. It is safe to freely share public keys. It is safe to transfer the new certificates by insecure methods, such as email, because they require their private keys to validate.

SSH certificates follow the OpenPGP standard, rather than SSL/TLS, and that the certificate format is OpenPGP, not X.509.

22.8.1 Setting up a new certificate authority

This section describes how to set up a new certificate authority (CA). Give careful consideration to organizing your CA, to keep it manageable and efficient.



Important: Protect your certificate authority

It is important to protect the machine that hosts your certificate authority. Your CA is literally the key to your entire network. Anyone who gains access to your CA can create their own certificates and freely access your network resources, or even compromise your servers and the CA itself. A common practice is to use a dedicated machine that is started only when you need to sign keys.

It is a best practice to create one signing key for servers, and another signing key for clients. If you have a large number of certificates to manage, it can be helpful to create your CAs for hosts and clients on separate machines. If you prefer using a single machine, give each CA its own directory. The examples in this section use `/ca-ssh-hosts` and `/ca-ssh-users`. The example machine is `ca.example.com`.

If your security policy requires keeping copies of users' and host's public keys, store them in their own subdirectories, for easier tracking and avoiding key name collisions.



Important: RSA signing keys deprecated

OpenSSH 8.2, released February 2020, deprecates RSA signing keys. Use Ed25519 or ECDSA.

The following examples create two signing keys, one for signing host keys, and one for user keys. Give them strong passphrases:

```
> sudo ssh-keygen -t ed25519 -f /ca-ssh-hosts/ca-host-sign-key -C "signing key for host certificates"
```

```

Generating public/private ed25519 key pair.
Enter passphrase (empty for no passphrase):
Enter same passphrase again:
Your identification has been saved in ca-host-sign-key
Your public key has been saved in ca-host-sign-key.pub
The key fingerprint is:
SHA256:STuQ7HgDrPcEa7ybNIW0n6kPbj28X5HN8GgwllBbAt0
  signing key for host certificates
The key's randomart image is:
+--[ED25519 256]--+
|      o+o..      |
|    . . o.=E     |
|    = + B .      |
|   + 0 + = B     |
|  . 0 * S = +    |
|   o B + o .     |
|   =0= .         |
|   o.*+ .        |
|   .=.0+.        |
+-----[SHA256]-----+

```

```

> sudo ssh-keygen -t ed25519 -f /ca-ssh-users/ca-user-sign-key -C "signing key for user certificates"

```

```

Generating public/private ed25519 key pair.
Enter passphrase (empty for no passphrase):
Enter same passphrase again:
Your identification has been saved in ca-user-sign-key
Your public key has been saved in ca-user-sign-key.pub
The key fingerprint is:
SHA256:taYj8tTnjkgfHRvQ6HTj8a37PY6rww96V1x+GHRjIk signing key for user certificates
The key's randomart image is:
+--[ED25519 256]--+
|                    |
|                    . +. |
|                    . E o.o |
|                    . + . .. |
|                    . S * o .+. |
|                    o + + = +..+ |
|                    . = * . 0 + o |
|                    + = = o =00+ |
|                    . o.o  o0X= |
+-----[SHA256]-----+

```

Copy your public user signing key (be sure you are copying the PUBLIC key) to `/etc/ssh` on all hosts running SSH servers. Then enter the full path of the public user signing key to `/etc/ssh/sshd_config` on the hosts:

```
TrustedUserCAKeys /etc/ssh/ca-user-sign-key.pub
```

Then restart `sshd`.

22.8.2 Creating host certificates

The following example signs a host public key to create a host certificate for a database server:

```
> sudo ssh-keygen -s /ca-ssh-hosts/ca-host-sign-key \
  -n venus,venus.example.com -I "db-server host cert" \
  -h -V +4w /etc/ssh/ssh_host_ed25519_key.pub
Enter passphrase:
Signed host key /etc/ssh/ssh_host_ed25519_key-cert.pub: id
"db-server host cert" serial 0 for venus,venus.example.com
valid from 2022-08-08T14:20:00 to 2022-09-05T15:21:19
```

If there is more than one host key on a server, sign them all.

- `-s` is your private signing key.
- `-n` is your list of principals. For host certificates, the principals are the machine's host name and fully qualified domain name.
- `-I` is the identity string. This is any comment or description you want. The string is logged, to help you quickly find relevant log entries.
- `-h` creates a host certificate.
- `-V` sets the expiration date for the certificate. In the example, the certificate expires in four weeks. (See the "`-V validity_interval`" section of [man 1 ssh-keygen](#) for allowed time formats.)

Verify that your new certificate is built the way you want:

```
> ssh-keygen -Lf /etc/ssh/ssh_host_ed25519_key-cert.pub
/etc/ssh/ssh_host_ed25519_key-cert.pub:
    Type: ssh-ed25519-cert-v01@openssh.com host certificate
```

```
Public key: ED25519-CERT SHA256:/
U7C+qABXYyuvueUuhFKzzVINq3d7IULRLwBstvVC+Q
Signing CA: ED25519 SHA256:
STuQ7HgDrPcEa7ybNIW0n6kPbj28X5HN8GgwllBbAt0 (using ssh-ed25519)
Key ID: "db-server host cert"
Serial: 0
Valid: from 2022-08-08T14:20:00 to 2022-09-05T15:21:19
Principals:
    venus
    venus.example.com
Critical Options: (none)
Extensions: (none)
```

Add the full path of the new host certificate to `/etc/ssh/sshd_config`, to make it available to clients:

```
HostCertificate /etc/ssh/ssh_host_ed25519_key-cert.pub
```

Restart `sshd` to load your changes:

```
> sudo systemctl restart sshd.service
```

See [Section 22.8.3, "CA configuration for users"](#) to learn how to configure clients to accept host certificates.

22.8.3 CA configuration for users

The following example shows how to configure clients to trust your CA rather than individual keys. The example grants access to a single server. This entry must be on a single unbroken line in your users' `~/.ssh/known_hosts` files. Move the original `~/.ssh/known_hosts` file, and create a new file that contains only the CA configuration. Or, create a global configuration in `/etc/ssh/ssh_known_hosts`, which has the advantage of being un-editable by unprivileged users:

```
@cert-authority db,db.example.com ssh-ed25519
AAAAC3NzaC1lZDI1NTE5AAAAIH1pF6DN4BdsfUKWuyiGt/leCvuZ/fPu
YxY7+4V68Fz0 signing key for user certificates
```

List each server the user is allowed to access in a comma-delimited list, for example `venus,venus.example.com,saturn,saturn.example.com`. You may also grant access to all servers in domains with wildcards, for example `*.example.com,*.example2.com`.

Try connecting to the server. You should be prompted for the password of the remote account, without being prompted to verify the host certificate.

22.8.4 Creating user certificates

Sign the user's public key:

```
> sudo ssh-keygen /ca-ssh-hosts/ca-user-sign-key -I "suzanne's cert" -n suzanne -V +52w
user-key.pub
Signed user key .ssh/ed25519key-cert.pub: id "suzanne's cert" serial 0
for suzanne valid from 2022-09-14T12:57:00 to 2023-09-13T12:58:21
```

The principal on user certificates is always the username. Store the user's certificate in `~/.ssh` on the user's machine.

User certificates replace the `~/.ssh/authorized_keys` files. Remove this file from a user account on the remote machine, then try opening an SSH session to that account. You should be able to log in without being prompted for a password. (Remember, the server should have a `TrustedUserCAKeys /etc/ssh/ca-user-sign-key.pub` line in its `/etc/ssh/sshd_config` file, so that the server knows to trust your certificate authority.)

Additionally, look for `Accepted publickey for suzanne` messages in your log files.

22.8.5 Revoking host keys

When you need to revoke a certificate because a server has been compromised or retired, add the certificate's corresponding public key to a file on every client, for example `/etc/ssh/revoked_keys`:

```
ssh-ed25519-cert-v01@openssh.com
AAAAIHNzaC1lZDI1NTE5LWNlcnQtdjAxQG9wZW5zc2guY29tAAAAIK6hyvFAhFI+0hkKehF/
506fD1Vdcw29ykffJn1CPK9lAAAAIAawaXbbEFiQ0Ae5LGclrCHSLWbEeUauK5+CAuhTJyz0
AAAAAAAAAAAAAAAAACAAAAE2RiLXNlcnZlciBob3N0IGNlcnQAAAAeAAAAABXZlbnVzAAAAEXZl
bnVzLmV4YW1wbGUuY29tAAAAAGMabhQAAAAAYz9YgQAAAAAAAAAAAAAAAAADMAAAALc3No
LWVkmjU1MTkAAAAgfwkXoM3gF2x9Qpa7KIa3+V4K+5n98+5jFjv7hXrwXPQAAABTAAAC3Nz
aC1lZDI1NTE5AAAAQI+mbJsQjt/9bLiURse8DF3yTa6Yk3HpoE2uf9FW/
KeLsw2wPeDv0d6jv49Wgr5T3xHYPf+VPJQW35ntFiHTlQg= root@db
```

This file must be named in `/etc/ssh/sshd_config`:

```
RevokedKeys /etc/ssh/revoked_keys
```

22.9 Automated public key logins with gnome-keyring

The `gnome-keyring` package is installed and enabled by default when the GNOME desktop environment is installed. `gnome-keyring` is integrated with your system login, automatically unlocking your secrets storage at login. When you change your login password, `gnome-keyring` automatically updates itself with your new password.

`gnome-keyring` automatically loads all key pairs in `~/.ssh`, for each pair that has a `*.pub` file. You may manually load other keys with the `ssh-add` command, for example:

```
> ssh-add ~/.otherkeys/my_key
```

List all loaded keys:

```
> ssh-add -L
```

When you start up your system and then open an SSH session, you are prompted for your private key passphrase.

`gnome-keyring` remembers the passphrase for the rest of your session. You do not have to re-enter the passphrase until after a system restart.

22.10 Automated public key logins with ssh-agent

The `openssh` package provides the `ssh-agent` utility, which retains your private keys and passphrases, and automatically applies your passphrases for you during the current session.

Configure `ssh-agent` to start automatically and load your keys by entering the following lines in your `~/.profile` file:

```
eval "$(ssh-agent)"
ssh-add
```

The first line starts `ssh-agent`, and the second line loads all the keys in your `~/.ssh` folder. When you open an SSH session that requires public key authentication, you are prompted for the passphrase. After the passphrase has been provided once, you do not have to enter it again, until after you restart your system.

You may configure `~/.profile` to load only specific keys, like the following example that loads `id_rsa` and `id_ed25519`:

```
> ssh-add id_rsa id_ed25519
```

22.10.1 Using `ssh-agent` in an X session

On SUSE Linux Enterprise Server, `ssh-agent` is automatically started by the GNOME display manager. To also invoke `ssh-add` to add your keys to the agent at the beginning of an X session, do the following:

1. Log in as the desired user and check whether the file `~/.xinitrc` exists.
2. If it does not exist, use an existing template or copy it from `/etc/skel`:

```
if [ -f ~/.xinitrc.template ]; then mv ~/.xinitrc.template ~/.xinitrc; \  
else cp /etc/skel/.xinitrc.template ~/.xinitrc; fi
```

3. If you have copied the template, search for the following lines and uncomment them. If `~/.xinitrc` already existed, add the following lines (without comment signs).

```
# if test -S "$SSH_AUTH_SOCK" -a -x "$SSH_ASKPASS"; then  
#     ssh-add < /dev/null  
# fi
```

4. When starting a new X session, you are prompted for your SSH passphrase.

22.11 Changing an SSH private key passphrase

You may change or remove the passphrase from a private key with `ssh-keygen`:

```
> ssh-keygen -pf ~/.ssh/server1  
Enter old passphrase:  
Key has comment 'shared videos server1'  
Enter new passphrase (empty for no passphrase):  
Enter same passphrase again:  
Your identification has been saved with the new passphrase.
```

22.12 Retrieving a key fingerprint

Use the `ssh-keygen` to display the public key fingerprint. The following example prints the SHA256 hash for a ED25519 key:

```
> ssh-keygen -lf ldap-server  
256 SHA256:W45lbnj24ZoASbrqW0q9+NhF04muvfKZ+FkRa2cCiqo comment (ED25519)
```

Add the `-v` flag to display the ASCII art representation of the key:

```
> ssh-keygen -lvf ldap-server
256 SHA256:W45lbnmj24ZoASbrqW0q9+NhF04muvfKZ+FkRa2cCiqr comment (ED25519)
+--[ED25519 256]--+
|
|
|   . . .
|  .o..+ +
|  ...o+ BSo+
|. ..o.o =X
|...o o..* =
|o.*.* =+ = .
|E*o*+0. o.o
+-----[SHA256]-----+
```

22.13 Starting X11 applications on a remote host

You can run graphical applications that are installed on a remote machine on your local computer. `X11Forwarding Yes` must be set in the `/etc/ssh/sshd_config` file on the remote machine. Then, when you run `ssh` with the `-X` option, the `DISPLAY` variable is automatically set on the remote machine, and all X output is exported to the local machine over the SSH connection. At the same time, X applications started remotely cannot be intercepted by unauthorized users.

A quick test is to run a simple game from the remote machine, such as GNOME Mines:

```
> ssh wilber@sun
Password:
Last login: Tue May 10 11:29:06 2022 from 192.168.163.13
Have a lot of fun...

wilber@sun> gnome-mines
```

The remote application should appear on your local machine just as though it were installed locally. (Network lag affects performance.) Close the remote application in the usual way, such as clicking the close button. This closes only the application, and your SSH session remains open.



Important: X11 forwarding does not work on Wayland

X11 forwarding requires the X Window System running on the remote host. The X Window System has built-in networking, while Wayland does not. Therefore Wayland does not support X11 forwarding.

Use the following command to learn if your system runs X or Wayland:

```
> echo $XDG_SESSION_TYPE
x11
```

If Wayland is in use, it looks like the following example:

```
> echo $XDG_SESSION_TYPE
wayland
```

The systemd way is to query with `loginctl`:

```
> loginctl show-session "$XDG_SESSION_ID" -p Type
Type=x11

> loginctl show-session "$XDG_SESSION_ID" -p Type
Type=wayland
```

22.14 Agent forwarding

By adding the `-A` option, the ssh-agent authentication mechanism is carried over to the next machine. This way, you can work from different machines without having to enter a password, but only if you have distributed your public key to the destination hosts and properly saved it there. (Refer to [Section 22.6, “Public key authentication”](#) to learn how to copy your public keys to other hosts.)

`AllowAgentForwarding yes` is the default in `/etc/ssh/sshd_config`. Change it to `No` to disable it.

22.15 scp—secure copy

`scp` copies files to or from a remote machine. If the user name on jupiter is different than the user name on sun, specify the latter using the `USER_NAME&host` format. If the file should be copied into a directory other than the remote user's home directory, specify it as `sun:DIRECTORY`. The following examples show how to copy a file from a local to a remote machine and vice versa.

```
> scp ~/MyLetter.tex tux@sun:/tmp ❶
> scp tux@sun:/tmp/MyLetter.tex ~ ❷
```

- 1 local to remote
- 2 remote to local

Tip: The `-l` option

With the `ssh` command, the option `-l` can be used to specify a remote user (as an alternative to the `USER_NAME&host` format). With `scp` the option `-l` is used to limit the bandwidth consumed by `scp`.

After the correct password is entered, `scp` starts the data transfer. It displays a progress bar and the time remaining for each file that is copied. Suppress all output with the `-q` option.

`scp` also provides a recursive copying feature for entire directories. The command

```
> scp -r src/ sun:backup/
```

copies the entire contents of the directory `src` including all subdirectories to the `~/backup` directory on the host `sun`. If this subdirectory does not exist, it is created automatically.

The `-p` option tells `scp` to leave the time stamp of files unchanged. `-C` compresses the data transfer. This minimizes the data volume to transfer, but creates a heavier burden on the processors of both machines.

22.16 `sftp`—secure file transfer

22.16.1 Using `sftp`

To copy several files from or to different locations, `sftp` is a convenient alternative to `scp`. It opens a shell with a set of commands similar to a regular FTP shell. Type `help` at the `sftp`-prompt to get a list of available commands. More details are available from the `sftp` man page.

```
> sftp sun
Enter passphrase for key '/home/tux/.ssh/id_rsa':
Connected to sun.
sftp> help
Available commands:
bye                Quit sftp
cd path            Change remote directory to 'path'
[...]
```

22.16.2 Setting permissions for file uploads

As with a regular FTP server, a user can download and upload files to a remote machine running an SFTP server by using the **put** command. By default the files are uploaded to the remote host with the same permissions as on the local host. There are two options to automatically alter these permissions:

Setting a umask

A umask works as a filter against the permissions of the original file on the local host. It can only withdraw permissions:

permissions original	umask	permissions uploaded
0666	0002	0664
0600	0002	0600
0775	0025	0750

To apply a umask on an SFTP server, edit the file `/etc/ssh/sshd_configuration`. Search for the line beginning with `Subsystem sftp` and add the `-u` parameter with the desired setting, for example:

```
Subsystem sftp /usr/lib/ssh/sftp-server -u 0002
```

Explicitly setting the permissions

Explicitly setting the permissions sets the same permissions for all files uploaded via SFTP. Specify a three-digit pattern such as `600`, `644`, or `755` with `-u`. When both `-m` and `-u` are specified, `-u` is ignored.

To apply explicit permissions for uploaded files on an SFTP server, edit the file `/etc/ssh/sshd_config`. Search for the line beginning with `Subsystem sftp` and add the `-m` parameter with the desired setting, for example:

```
Subsystem sftp /usr/lib/ssh/sftp-server -m 600
```



Tip: Viewing the SSH daemon log file

To watch the log entries from the `sshd` use the following command:

```
> sudo journalctl -u sshd
```

22.17 Port forwarding (SSH tunneling)

`ssh` can also be used to redirect TCP/IP connections. This feature, also called SSH tunneling, redirects TCP connections to a certain port to another machine via an encrypted channel.

With the following command, any connection directed to jupiter port 25 (SMTP) is redirected to the SMTP port on sun. This is especially useful for those using SMTP servers without SMTP-AUTH or POP-before-SMTP features. From any arbitrary location connected to a network, e-mail can be transferred to the “home” mail server for delivery.

```
# ssh -L 25:sun:25 jupiter
```

Similarly, all POP3 requests (port 110) on jupiter can be forwarded to the POP3 port of sun with this command:

```
# ssh -L 110:sun:110 jupiter
```

Both commands must be executed as root, because the connection is made to privileged local ports. E-mail is sent and retrieved by normal users in an existing SSH connection. The SMTP and POP3 host must be set to localhost for this to work. Additional information can be found in the manual pages for each of the programs described above and in the OpenSSH package documentation under /usr/share/doc/packages/openssh.

22.18 More information

<https://www.openssh.com> ↗

The home page of OpenSSH

<https://en.wikibooks.org/wiki/OpenSSH> ↗

The OpenSSH Wikibook

man sshd

The man page of the OpenSSH daemon

man ssh_config

The man page of the OpenSSH SSH client configuration files

man scp ,
man sftp ,
man ssh ,
man ssh-add ,
man ssh-copy-id ,
man ssh-keygen

Man pages of several binary files to securely copy files (scp, sftp), to log in (slogin, ssh), and to manage keys.

/usr/share/doc/packages/openssh-common/README.SUSE ,
/usr/share/doc/packages/openssh-common/README.FIPS

SUSE package specific documentation; changes in defaults with respect to upstream, notes on FIPS mode etc.

22.19 Stopping SSH brute force attacks with Fail2Ban

An SSH brute force attack involves repeated trials of user name and password combinations until the attacker gains access to the remote server. The attacker uses automated tools that test various user name and password combinations to compromise a server.

You can use Fail2Ban software to limit intrusion attempts. Fail2Ban scans the system logs to detect attacks and trigger an action, such as blocking the IPs via the firewall. Fail2Ban is used only to protect services that require a user name and password authentication.

22.19.1 What is Fail2Ban?

Fail2Ban scans the log files in /var/log/apache/error_log and bans IPs that indicate malicious signs, such as too many password attempts, etc. You can then use Fail2Ban to update firewall rules to reject the IP addresses for a specified amount of time.

Fail2Ban comes with filters for various services, such as Apache, SSH, Courier, etc. You can use Fail2Ban to minimize the rate of incorrect authentication attempts.

22.19.2 Using Fail2Ban to stop an SSH brute force attack

You can install and configure Fail2Ban to protect the server against SSH brute force attacks.

PROCEDURE 22.2: USING FAIL2BAN TO STOP AN SSH BRUTE FORCE ATTACK

1. To install Fail2Ban, execute:

```
# sudo zypper -n in fail2ban firewalld
```

2. When you install Fail2Ban, a default configuration file `jail.conf` is also installed. This file gets overwritten when you upgrade Fail2Ban. To retain any customizations you make to the file, you can add the modifications to a file called `jail.local`. Fail2Ban automatically reads both files.

```
# cp /etc/fail2ban/jail.conf /etc/fail2ban/jail.local
```

3. Open the file in your editor.

```
vi /etc/fail2ban/jail.local
```

4. Take a look at the four settings that you need to know about.

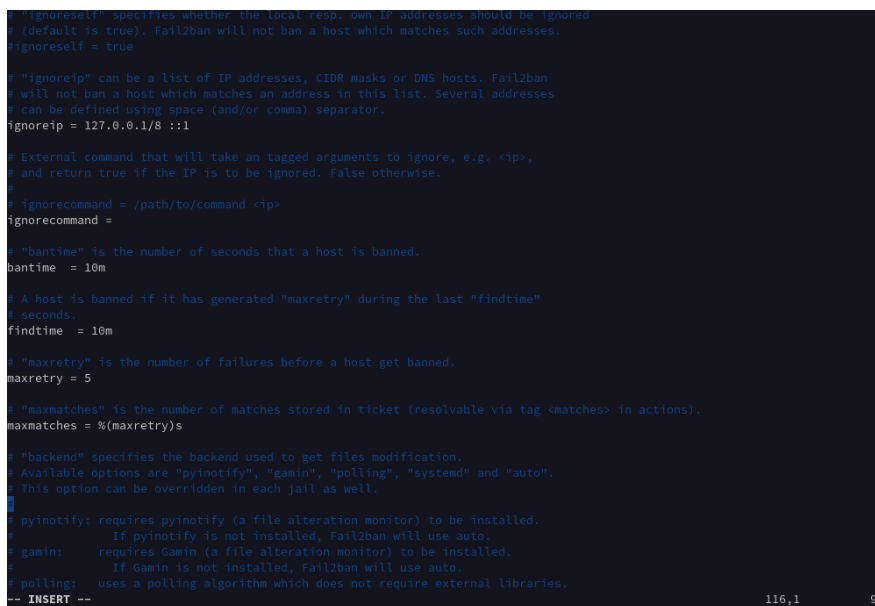
A screenshot of a terminal window showing the contents of the `/etc/fail2ban/jail.local` file. The text is as follows:

```

# "ignoreself" specifies whether the local resp. own IP addresses should be ignored
# (default is true). Fail2ban will not ban a host which matches such addresses.
ignoreself = true

# "ignoreip" can be a list of IP addresses, CIDR masks or DNS hosts. Fail2ban
# will not ban a host which matches an address in this list. Several addresses
# can be defined using space (and/or comma) separator.
ignoreip = 127.0.0.1/8 ::1

# External command that will take an tagged arguments to ignore, e.g. <ip>,
# and return true if the IP is to be ignored. False otherwise.
# ignorecommand = /path/to/command <ip>
ignorecommand =

# "bantime" is the number of seconds that a host is banned.
bantime = 10m

# A host is banned if it has generated "maxretry" during the last "findtime"
# seconds.
findtime = 10m

# "maxretry" is the number of failures before a host get banned.
maxretry = 5

# "maxmatches" is the number of matches stored in ticket (resolvable via tag <matches> in actions).
maxmatches = %(maxretry)s

# "backend" specifies the backend used to get files modification.
# Available options are "pyinotify", "gamin", "polling", "systemd" and "auto".
# This option can be overridden in each jail as well.
#
# pyinotify: requires pyinotify (a file alteration monitor) to be installed.
#             If pyinotify is not installed, Fail2ban will use auto.
# gamin:     requires Gamin (a file alteration monitor) to be installed.
#             If Gamin is not installed, Fail2ban will use auto.
# polling:   uses a polling algorithm which does not require external libraries.
-- INSERT --
116,1 9%
```

FIGURE 22.1: `JAIL.LOCAL` FILE SETTINGS

ignoreip

A list of whitelisted IPs that are never banned. The local host IP address `127.0.0.1` is in the list by default, along with the IPv6 equivalent `::1`. You can use this setting to add a list of IP addresses that you know should not be banned.

bantime

The duration in minutes for which an IP address is banned. When you do not enter a value ending in *m* or *h*, it is treated as seconds. If you enter a value of *-1*, an IP address is permanently banned.

findtime

The period of time within which too many failed connection attempts result in an IP being banned.

maxretry

The limit for the number of failed attempts.



Note

If a connection from the same IP address makes *maxretry* failed connection attempts within the *findtime* period, they are banned for the duration of the *bantime*. The only exceptions are the IP addresses in the *ignoreip* list.

Fail2Ban supports different types of jails, and each jail has different settings for the connection types.

5. You can use the Fail2Ban service with the following:

To enable:

```
# systemctl enable fail2ban
```

To start:

```
# systemctl start fail2ban
```

To check the service status:

```
# systemctl status fail2ban.service
```



Important

You must restart Fail2Ban each time you make a configuration change.

23 Masquerading and firewalls

Whenever Linux is used in a network environment, you can use the kernel functions that allow the manipulation of network packets to maintain a separation between internal and external network areas. The Linux `netfilter` framework provides the means to establish an effective firewall that keeps different networks apart. Using iptables—a generic table structure for the definition of rule sets—precisely controls the packets allowed to pass a network interface. Such a packet filter can be set up using `firewalld` and its graphical interface `firewall-config`.

SUSE Linux Enterprise Server 15 GA introduces `firewalld` as the new default software firewall, replacing SuSEfirewall2. This chapter provides guidance for configuring `firewalld`, and migrating from SuSEfirewall2 for users who have upgraded from older SUSE Linux Enterprise Server releases.

23.1 Packet filtering with iptables

This section discusses the low-level details of packet filtering. The components `netfilter` and `iptables` are responsible for the filtering and manipulation of network packets and for network address translation (NAT). The filtering criteria and any actions associated with them are stored in chains, which must be matched one after another by individual network packets as they arrive. The chains to match are stored in tables. The `iptables` command allows you to alter these tables and rule sets.

The Linux kernel maintains three tables, each for a particular category of functions of the packet filter:

filter

This table holds the bulk of the filter rules, because it implements the *packet filtering* mechanism in the stricter sense, which determines whether packets are let through (`ACCEPT`) or discarded (`DROP`), for example.

nat

This table defines any changes to the source and target addresses of packets. Using these functions also allows you to implement *masquerading*, which is a special case of NAT used to link a private network with the Internet.

mangle

The rules held in this table make it possible to manipulate values stored in IP headers (such as the type of service).

These tables contain several predefined chains to match packets:

PREROUTING

This chain is applied to all incoming packets.

INPUT

This chain is applied to packets destined for the system's internal processes.

FORWARD

This chain is applied to packets that are routed through the system.

OUTPUT

This chain is applied to packets originating from the system itself.

POSTROUTING

This chain is applied to all outgoing packets.

Figure 23.1, "iptables: a packet's possible paths" illustrates the paths along which a network packet may travel on a given system. For the sake of simplicity, the figure lists tables as parts of chains, but in reality these chains are held within the tables themselves.

In the simplest case, an incoming packet destined for the system itself arrives at the `eth0` interface. The packet is first referred to the `PREROUTING` chain of the `mangle` table then to the `PREROUTING` chain of the `nat` table. The following step, concerning the routing of the packet, determines that the actual target of the packet is a process of the system itself. After passing the `INPUT` chains of the `mangle` and the `filter` table, the packet finally reaches its target, provided that the rules of the `filter` table allow this.

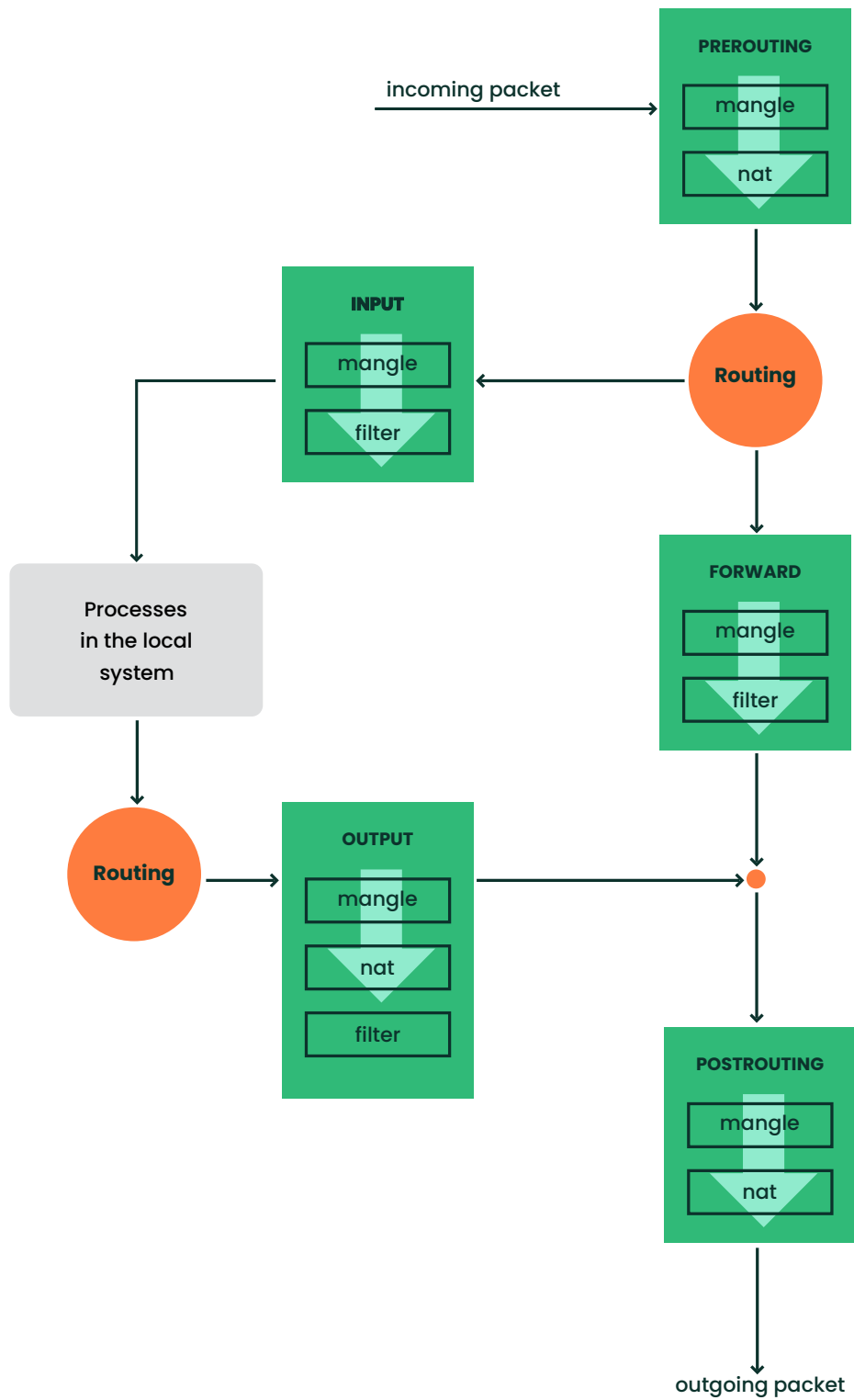

FIGURE 23.1: IPTABLES: A PACKET'S POSSIBLE PATHS

23.2 Masquerading basics

Masquerading is the Linux-specific form of NAT (network address translation) and can be used to connect a small LAN with the Internet. LAN hosts use IP addresses from the private range (see Book "Administration Guide", Chapter 23 "Basic networking", Section 23.1.2 "Netmasks and routing") and on the Internet official IP addresses are used. To be able to connect to the Internet, a LAN host's private address is translated to an official one. This is done on the router, which acts as the gateway between the LAN and the Internet. The underlying principle is a simple one: The router has more than one network interface, typically a network card and a separate interface connecting with the Internet. While the latter links the router with the outside world, one or several others link it with the LAN hosts. With these hosts in the local network connected to the network card (such as `eth0`) of the router, they can send any packets not destined for the local network to their default gateway or router.



Important: Using the correct network mask

When configuring your network, make sure both the broadcast address and the netmask are the same for all local hosts. Failing to do so prevents packets from being routed properly.

As mentioned, whenever one of the LAN hosts sends a packet destined for an Internet address, it goes to the default router. However, the router must be configured before it can forward such packets. For security reasons, this is not enabled in a default installation. To enable it, add the line `net.ipv4.ip_forward = 1` in the file `/etc/sysctl.conf`. Alternatively do this via YaST, for example by calling **yast routing ip-forwarding on**.

The target host of the connection can see your router, but knows nothing about the host in your internal network where the packets originated. This is why the technique is called masquerading. Because of the address translation, the router is the first destination of any reply packets. The router must identify these incoming packets and translate their target addresses, so packets can be forwarded to the correct host in the local network.

With the routing of inbound traffic depending on the masquerading table, there is no way to open a connection to an internal host from the outside. For such a connection, there would be no entry in the table. In addition, any connection already established has a status entry assigned to it in the table, so the entry cannot be used by another connection.

As a consequence of all this, you might experience some problems with several application protocols, such as ICQ, cucme, IRC (DCC, CTCP), and FTP (in PORT mode). Web browsers, the standard FTP program, and many other programs use the PASV mode. This passive mode is much less problematic as far as packet filtering and masquerading are concerned.

23.3 Firewalling basics

Firewall is probably the term most widely used to describe a mechanism that controls the data flow between networks. Strictly speaking, the mechanism described in this section is called a *packet filter*. A packet filter regulates the data flow according to certain criteria, such as protocols, ports, and IP addresses. This allows you to block packets that, according to their addresses, are not supposed to reach your network. To allow public access to your Web server, for example, explicitly open the corresponding port. However, a packet filter does not scan the contents of packets with legitimate addresses, such as those directed to your Web server. For example, if incoming packets were intended to compromise a CGI program on your Web server, the packet filter would still let them through.

A more effective but more complex mechanism is the combination of several types of systems, such as a packet filter interacting with an application gateway or proxy. In this case, the packet filter rejects any packets destined for disabled ports. Packets that are directed to the application gateway are accepted. This gateway or proxy pretends to be the actual client of the server. In a sense, such a proxy could be considered a masquerading host on the protocol level used by the application. One example for such a proxy is Squid, an HTTP and FTP proxy server. To use Squid, the browser must be configured to communicate via the proxy. Any HTTP pages or FTP files requested are served from the proxy cache and objects not found in the cache are fetched from the Internet by the proxy.

The following section focuses on the packet filter that comes with SUSE Linux Enterprise Server. For further information about packet filtering and firewalling, read the [Firewall HOWTO \(https://tldp.org/HOWTO/Firewall-HOWTO.html\)](https://tldp.org/HOWTO/Firewall-HOWTO.html).

23.4 firewalld



Note: firewalld replaces SuSEfirewall2

SUSE Linux Enterprise Server 15 GA introduces `firewalld` as the new default software firewall, replacing `SuSEfirewall2`. If you are upgrading from a release older than SUSE Linux Enterprise Server 15 GA, `SuSEfirewall2` will be unchanged and you must manually upgrade to `firewalld` (see [Section 23.5, "Migrating from SuSEfirewall2"](#)).

`firewalld` is a daemon that maintains the system's `iptables` rules and offers a D-Bus interface for operating on them. It comes with a command line utility `firewall-cmd` and a graphical user interface `firewall-config` for interacting with it. Since `firewalld` is running in the background and provides a well defined interface it allows other applications to request changes to the `iptables` rules, for example to set up virtual machine networking.

`firewalld` implements different security zones. Several predefined zones like `internal` and `public` exist. The administrator can define additional custom zones if desired. Each zone contains its own set of `iptables` rules. Each network interface is a member of exactly one zone. Individual connections can also be assigned to a zone based on the source addresses.

Each zone represents a certain level of trust. For example the `public` zone is not trusted, because other computers in this network are not under your control (suitable for Internet or wireless hotspot connections). On the other hand the `internal` zone is used for networks that *are* under your control, like a home or company network. By utilizing zones this way, a host can offer different kinds of services to trusted networks and untrusted networks in a defined way.

For more information about the predefined zones and their meaning in `firewalld`, refer to its manual at <https://www.firewalld.org/documentation/zone/predefined-zones.html>.



Note: No zone assigned behavior

The initial state for network interfaces is to be assigned to no zone at all. In this case the network interface will be implicitly handled in the default zone, which can be determined by calling `firewall-cmd --get-default-zone`. If not configured otherwise, the default zone is the `public` zone.

The `firewalld` packet filtering model allows any outgoing connections to pass. Outgoing connections are connections that are actively established by the local host. Incoming connections that are established by remote hosts are blocked if the respective service is not allowed in the zone in question. Therefore, each of the interfaces with incoming traffic must be placed in a suitable zone to allow for the desired services to be accessible. For each of the zones, define the services or protocols you need.

An important concept of `firewalld` is the distinction between two separate configurations: the *runtime* and the *permanent* configuration. The runtime configuration represents the currently active rules, while the permanent configuration represents the saved rules that will be applied when restarting `firewalld`. This allows to add temporary rules that will be discarded after restarting `firewalld`, or to experiment with new rules while being able to revert back to the original state. When you are changing the configuration, you need to be aware of which configuration you are editing. How this is done is discussed in [Section 23.4.3.2, “Runtime versus permanent configuration”](#).

To perform the `firewalld` configuration using the graphical user interface `firewall-config` refer to its [documentation \(https://www.firewalld.org/documentation/utilities/firewall-config.html\)](https://www.firewalld.org/documentation/utilities/firewall-config.html). In the following section we will be looking at how to perform typical `firewalld` configuration tasks using `firewall-cmd` on the command line.

23.4.1 Configuring the firewall with NetworkManager

The NetworkManager supports a basic configuration of `firewalld` by selecting zones.

When editing a wired or wireless connection, go to the *Identity* tab in the configuration window and use the `Firewall Zone` drop-down box.

23.4.2 Configuring the firewall with YaST

The `yast firewall` module supports a basic configuration of `firewalld`. It provides a zone selector, services selector, and ports selector. It does not support creating custom iptables rules, and limits zone creation and customization to selecting services and ports.



Note: Changing settings in running mode

YaST respects the settings in `/etc/firewalld/firewalld.conf`, where the default value for `FlushAllOnReload` is set to `no`. Therefore, YaST does not change settings in running mode. For example, if you have assigned an interface to a different zone with YaST, restart the `firewalld` daemon for the change to take effect.

23.4.3 Configuring the firewall on the command line

23.4.3.1 Firewall start-up

`firewalld` will be installed and enabled by default. It is a regular `systemd` service that can be configured via `systemctl` or the YaST Services Manager.



Important: Automatic firewall configuration

After the installation, YaST automatically starts `firewalld` and leaves all interfaces in the default `public` zone. If a server application is configured and activated on the system, YaST can adjust the firewall rules via the options *Open Ports on Selected Interface in Firewall* or *Open Ports on Firewall* in the server configuration modules. Some server module dialogs include a *Firewall Details* button for activating additional services and ports.

23.4.3.2 Runtime versus permanent configuration

By default, all `firewall-cmd` commands operate on the runtime configuration. You can apply most operations to the permanent configuration *only* by adding the `--permanent` parameter. When doing so, the change affects the permanent configuration and will not be effective immediately in the runtime configuration. There is currently no way to add a rule to both runtime and permanent configurations in a single invocation. To achieve this you can apply all necessary changes to the runtime configuration and when all is working as expected issue the following command:

```
# firewall-cmd --runtime-to-permanent
```

This writes all current runtime rules into the permanent configuration. Any temporary modifications you or other programs may have made to the firewall in other contexts are made permanent this way. If you are unsure about this, you can also take the opposite approach to be on the safe side: Add new rules to the permanent configuration and reload `firewalld` to make them active.



Note

Some configuration items, like the default zone, are shared by both the runtime and permanent configurations. Changing them reflects in both configurations at once.

To revert the runtime configuration to the permanent configuration and thereby discard any temporary changes, two possibilities exist, either via the `firewalld` command line interface or via `systemd`:

```
# firewall-cmd --reload
```

```
# systemctl reload firewalld
```

For brevity the examples in the following sections will always operate on the runtime configuration, if applicable. Adjust them accordingly to make them permanent.

23.4.3.3 Assignment of interfaces to zones

You can list all network interfaces currently assigned to a zone like this:

```
# firewall-cmd --zone=public --list-interfaces
eth0
```

Similarly you can query which zone a specific interface is assigned to:

```
# firewall-cmd --get-zone-of-interface=eth0
public
```

The following command lines assign an interface to a zone. The variant using `--add-interface` works if `eth0` is not already assigned to another zone. The variant using `--change-interface` always works, removing `eth0` from its current zone if necessary:

```
# firewall-cmd --zone=internal --add-interface=eth0
```

```
# firewall-cmd --zone=internal --change-interface=eth0
```

Any operations without an explicit `--zone` argument will implicitly operate on the default zone. This pair of commands can be used for getting and setting the default zone assignment:

```
# firewall-cmd --get-default-zone
dmz
# firewall-cmd --set-default-zone=public
```

Important

Any network interfaces not explicitly assigned to a zone are automatically part of the default zone. Changing the default zone reassigns all those network interfaces immediately for the permanent and runtime configurations. You should never use a trusted zone like `internal` as the default zone, to avoid unexpected exposure to threats. For example, hotplugged network interfaces like USB Ethernet interfaces would automatically become part of the trusted zone in such cases.

Interfaces that are not explicitly part of any zone do not appear in the zone interface list. There is currently no command to list unassigned interfaces. Due to this it is best to avoid unassigned network interfaces during regular operation.

23.4.3.4 Making network services accessible

`firewalld` has a concept of *services*. A service consists of definitions of ports and protocols. These definitions logically belong together in the context of a given network service like a Web or mail server protocol. The following commands can be used to get information about predefined services and their details:

```
# firewall-cmd --get-services
[...] dhcp dhcpv6 dhcpv6-client dns docker-registry [...]
# firewall-cmd --info-service dhcp
dhcp
  ports: 67/udp
  protocols:
  source-ports:
  modules:
  destination:
```

These service definitions can be used for easily making the associated network functionality accessible in a zone. This command line opens the HTTP Web server port in the internal zone, for example:

```
# firewall-cmd --add-service=http --zone=internal
```

The removal of a service from a zone is performed using the counterpart command `--remove-service`. You can also define custom services using the `--new-service` subcommand. Refer to <https://www.firewalld.org/documentation/howto/add-a-service.html> for more details on how to do this.

If you just want to open a single port by number, you can use the following approach. This will open TCP port 8000 in the internal zone:

```
# firewall-cmd --add-port=8000/tcp --zone=internal
```

For removal use the counterpart command `--remove-port`.



Tip: Temporarily opening a service or port

`firewalld` supports a `--timeout` parameter that allows to open a service or port for a limited time duration. This can be helpful for quick testing and making sure that closing the service or port is not forgotten. To allow the `imap` service in the `internal` zone for 5 minutes, you would call

```
# firewall-cmd --add-service=imap --zone=internal --timeout=5m
```

23.4.3.5 Lockdown mode

`firewalld` offers a *lockdown mode* that prevents changes to the firewall rules while it is active. Since applications can automatically change the firewall rules via the D-Bus interface, and depending on the PolicyKit rules regular users may be able to do the same, it can be helpful to prevent changes in some situations. You can find more information about this at <https://fedoraproject.org/wiki/Features/FirewalldLockdown>.

It is important to understand that the lockdown mode feature provides no real security, but merely protection against accidental or benign attempts to change the firewall. The way the lockdown mode is currently implemented in `firewalld` provides no security against malicious intent, as is pointed out at <https://seclists.org/oss-sec/2017/q3/139>.

23.4.3.6 Adding custom `iptables` rules

`firewalld` claims exclusive control over the host's `netfilter` rules. You should never modify firewall rules using other tools like `iptables`. Doing so could confuse `firewalld` and break security or functionality.

If you need to add custom firewall rules that aren't covered by `firewalld` features then there are two ways to do so. To directly pass raw `iptables` syntax you can use the `--direct` option. It expects the table, chain, and priority as initial arguments and the rest of the command line is passed as is to `iptables`. The following example adds a connection tracking rule for the forwarding filter table:

```
# firewall-cmd --direct --add-rule ipv4 filter FORWARD 0 -i eth0 -o eth1 \  
-p tcp --dport 80 -m state --state NEW,RELATED,ESTABLISHED -j ACCEPT
```

Additionally, `firewalld` implements so called *rich rules*, an extended syntax for specifying `iptables` rules in an easier way. You can find the syntax specification at <https://www.firewalld.org/documentation/man-pages/firewalld.richlanguage.html>. The following example drops all IPv4 packets originating from a certain source address:

```
# firewall-cmd --zone=public --add-rich-rule='rule family="ipv4" \  
source address="192.168.2.4" drop'
```

23.4.3.7 Routing, forwarding, and masquerading

`firewalld` is not designed to run as a fully fledged router. The basic functionality for typical home router setups is available. For a corporate production router you should not use `firewalld`, however, but use dedicated router and firewall devices instead. The following provides just a few pointers on what to look for to utilize routing in `firewalld`:

- First of all IP forwarding needs to be enabled as outlined in [Section 23.2, “Masquerading basics”](#).
- To enable IPv4 masquerading, for example in the `internal` zone, issue the following command.

```
# firewall-cmd --zone=internal --add-masquerade
```

- `firewalld` can also enable port forwarding. The following command forwards local TCP connections on port 80 to another host:

```
# firewall-cmd --zone=public \  
--add-forward-port=port=80:proto=tcp:toport=80:toaddr=192.168.1.10
```

23.4.4 Accessing services listening on dynamic ports

Some network services do not listen on predefined port numbers. Instead they operate based on the `portmapper` or `rpcbind` protocol. We will use the term `rpcbind` from here on. When one of these services starts, it chooses a random local port and talks to `rpcbind` to make the port number known. `rpcbind` itself is listening on a well known port. Remote systems can then query `rpcbind` about the network services it knows about and on which ports they are listening. Not many programs use this approach anymore today. Popular examples are Network Information Services (NIS; `ypserv` and `ypbind`) and the Network File System (NFS) version 3.



Note: About NFSv4

The newer NFSv4 requires the single well-known TCP port 2049. For protocol version 4.0, the kernel parameter `fs.nfs.nfs_callback_tcpport` may need to be set to a static port (see [Example 23.1, “Callback port configuration for the nfs kernel module in /etc/modprobe.d/60-nfs.conf”](#)). Starting with protocol version 4.1 this setting has also become unnecessary.

The dynamic nature of the `rpcbind` protocol makes it difficult to make the affected services behind the firewall accessible. `firewalld` does not support these services by itself. For manual configuration, see [Section 23.4.4.1, “Configuring static ports”](#). Alternatively, SUSE Linux Enterprise Server provides a helper script. For details, see [Section 23.4.4.2, “Using firewall-rpcbind-helper for configuring static ports”](#).

23.4.4.1 Configuring static ports

One possibility is to configure all involved network services to use fixed port numbers. Once this is done, the fixed ports can be opened in `firewalld` and everything should work. The actual port numbers used are at your discretion but should not clash with any well-known port numbers assigned to other services. See [Table 23.1, “Important sysconfig variables for static port configuration”](#) for a list of the available configuration items for NIS and NFSv3 services. Depending on your actual NIS or NFS configuration, not all of these ports may be required for your setup.

TABLE 23.1: IMPORTANT SYSCONFIG VARIABLES FOR STATIC PORT CONFIGURATION

File Path	Variable Name	Example Value
<u>/etc/sysconfig/nfs</u>	MOUNTD_PORT	21001
	STATD_PORT	21002
	LOCKD_TCP	21003
	LOCKD_UDP	21003
	RQUOTAD_PORT	21004
<u>/etc/sysconfig/ypbind</u>	YPBIND_OPTIONS	-p 24500
<u>/etc/sysconfig/ypserv</u>	YPXFRD_ARGS	-p 24501
	YPSERV_ARGS	-p 24502
	YPPASSWDD_ARGS	--port 24503

You need to restart any related services that are affected by these static port configurations for the changes to take effect. You can see the currently assigned `rpcbind` ports by using the command `rpcinfo -p`. On success, the statically configured ports should show up there.

Apart from the port configuration for network services running in userspace there are also ports that are used by the Linux kernel directly when it comes to NFS. One of these ports is `nfs_callback_tcpport`. It is only required for NFS protocol versions older than 4.1. There is a `sysctl` named `fs.nfs.nfs_callback_tcpport` to configure this port. This `sysctl` node only appears dynamically when NFS mounts are active. Therefore it is best to configure the port via kernel module parameters. This can be achieved by creating a file as shown in [Example 23.1, “Callback port configuration for the nfs kernel module in /etc/modprobe.d/60-nfs.conf”](#).

EXAMPLE 23.1: CALLBACK PORT CONFIGURATION FOR THE `nfs` KERNEL MODULE IN `/etc/modprobe.d/60-nfs.conf`

```
options nfs callback_tcpport=21005
```

To make this change effective it is easiest to reboot the machine. Otherwise all NFS services need to be stopped and the `nfs` kernel module needs to be reloaded. To verify the active NFS callback port, check the output of `cat /sys/module/nfs/parameters/callback_tcpport`.

For easy handling of the now statically configured RPC ports, it is useful to create a new `firewalld` service definition. This service definition groups all related ports and, for example, makes it easy to make them accessible in a specific zone. In *Example 23.2, "Commands to define a new firewalld RPC service for NFS"* this is done for the NFS ports as they have been configured in the accompanying examples.

EXAMPLE 23.2: COMMANDS TO DEFINE A NEW `firewalld` RPC SERVICE FOR NFS

```
# firewall-cmd --permanent --new-service=nfs-rpc
# firewall-cmd --permanent --service=nfs-rpc --set-description="NFS related, statically
  configured RPC ports"
# add UDP and TCP ports for the given sequence
# for port in 21001 21002 21003 21004; do
    firewall-cmd --permanent --service=nfs-rpc --add-port ${port}/udp --add-port ${port}/
tcp
done
# the callback port is TCP only
# firewall-cmd --permanent --service=nfs-rpc --add-port 21005/tcp

# show the complete definition of the new custom service
# firewall-cmd --info-service=nfs-rpc --permanent -v
nfs-rpc
  summary:
  description: NFS and related, statically configured RPC ports
  ports: 4711/tcp 21001/udp 21001/tcp 21002/udp 21002/tcp 21003/udp 21003/tcp 21004/udp
  21004/tcp
  protocols:
  source-ports:
  modules:
  destination:

# reload firewalld to make the new service definition available
# firewall-cmd --reload

# the new service definition can now be used to open the ports for example in the
  internal zone
```



```
# firewall-cmd --add-service=nfs-rpc --zone=internal
```

23.4.4.2 Using `firewall-rpcbind-helper` for configuring static ports

The steps to configure static ports as shown in the previous section can be simplified by using the SUSE helper tool `firewall-rpc-helper.py`. Install it with `zypper in firewalld-rpcbind-helper`.

The tool allows interactive configuration of the service patterns discussed in the previous section. It can also display current port assignments and can be used for scripting. For details, see `firewall-rpc-helper.py --help`.

23.4.4.3 `nftables` as the default back-end

The default back-end for `firewalld` is `nftables`. `nftables` is a framework by the Linux `netfilter` project that provides packet filtering, network address translation (NAT) and other similar functionalities. `nftables` reuses the existing Netfilter subsystems such as the connection tracking system, user space queueing, logging and the hook infrastructure. `nftables` is a replacement for `iptables`, `ip6tables`, `arptables`, `ebtables`, and `ipset`.

The advantages of using `nftables` include:

- One framework for both the IPv4 and IPv6 protocols.
- Rules are applied atomically instead of fetching, updating and storing a complete rule set.
- Monitor trace events in the `nft` tool, debug and trace the ruleset via `nfttrace`.
- The `nft` command line tool compiles into VM bytecode in netlink format. During the rule set retrieval, the VM bytecode in netlink format is translated back into the original ruleset representation.

A basic `nftables` configuration file:

```
> cat /etc/nftables.conf
#!/usr/sbin/nft -f

flush ruleset

# This matches IPv4 and IPv6
table inet filter {
    # chain names are up to you.
```

```

# what part of the traffic they cover,
# depends on the type table.
chain input {
    type filter hook input priority 0; policy accept;
}
chain forward {
    type filter hook forward priority 0; policy accept;
}
chain output {
    type filter hook output priority 0; policy accept;
}
}

```

In the above example, all traffic is allowed because all chains have the policy *accept*. Note that, in reality, this is a bad practice, as firewalls should deny traffic by default.

A basic nftables configuration file with masquerade:

```

> cat /etc/nftables.conf
#!/sbin/nft -f

flush ruleset

table ip nat {
    chain prerouting {
        type nat hook prerouting priority 0; policy accept;
    }

    # for all packets to WAN, after routing, replace source address with primary IP of
    WAN interface
    chain postrouting {
        type nat hook postrouting priority 100; policy accept;
        oifname "wan0" masquerade
    }
}

```

If you have a static IP, it would be slightly faster to use source nat (SNAT) instead of masquerade. The router replaces the source with a predefined IP instead of looking up the outgoing IP for every packet.

An nftables configuration file with some rules applied:

```

> cat /etc/nftables.conf
#!/usr/sbin/nft -f

flush ruleset

table inet filter {

```

```

chain base_checks {
    ## another set, this time for connection tracking states.
    # allow established/related connections
    ct state {established, related} accept;

    # early drop of invalid connections
    ct state invalid drop;
}

chain input {
    type filter hook input priority 0; policy drop;

    # allow from loopback
    iif "lo" accept;

    jump base_checks;

    # allow icmp and igmp
    ip6 nexthdr icmpv6 icmpv6 type { echo-request, echo-reply, packet-too-big, time-
exceeded, parameter-problem, destination-unreachable, packet-too-big, mld-listener-query,
mld-listener-report, mld-listener-reduction, nd-router-solicit, nd-router-advert, nd-
neighbor-solicit, nd-neighbor-advert, ind-neighbor-solicit, ind-neighbor-advert, mld2-
listener-report } accept;
    ip protocol icmp icmp type { echo-request, echo-reply, destination-unreachable,
router-solicitation, router-advertisement, time-exceeded, parameter-problem } accept;
    ip protocol igmp accept;

    # for testing reject with logging
    counter log prefix "[nftables] input reject " reject;
}
chain forward {
    type filter hook forward priority 0; policy accept;
}
chain output {
    type filter hook output priority 0; policy accept;
}
}

```

In the above example:

- The chain policy is to drop and add a reject rule at the end, which means all incoming traffic is blocked.
- All traffic on the localhost interface is allowed.
- The base_checks chain handles all packets that are related to established connections. This ensures that incoming packets for outgoing connections are not blocked.

- ICMP and IGMP packets are allowed by utilizing a set and specific type names.
- A counter keeps a count of both the total number of packets and bytes it has seen since it was last reset. With nftables, you must specify a counter for each rule you want to count.

23.4.4.3.1 More information

For more information about nftables, see:

- Upstream documentation <https://www.netfilter.org/projects/nftables/index.html> ↗
- nftables man page <https://www.netfilter.org/projects/nftables/manpage.html> ↗

23.5 Migrating from SuSEfirewall2



Note: Creating a firewalld configuration for AutoYaST

See the *Firewall Configuration* section of the AutoYaST Guide to learn how to create a firewalld configuration for AutoYaST.

When upgrading from any service pack of SUSE Linux Enterprise Server 12 to SUSE Linux Enterprise Server 15 SP6, SuSEfirewall2 is not changed and remains active. There is no automatic migration, so you must migrate to firewalld manually. firewalld includes a helper migration script, susefirewall2-to-firewalld. Depending on the complexity of your SuSEfirewall2 configuration, the script may perform a perfect migration, or it may fail. Most likely it will partially succeed and you have to review your new firewalld configuration and make adjustments.

The resulting configuration makes firewalld behave somewhat like SuSEfirewall2. To take full advantage of firewalld's features, you may elect to create a new configuration, rather than trying to migrate your old configuration. It is safe to run the susefirewall2-to-firewalld script with no options, as it makes no permanent changes to your system. However, if you are administering the system remotely you could get locked out.

Install and run susefirewall2-to-firewalld:

```
# zypper in susefirewall2-to-firewalld
# susefirewall2-to-firewalld
INFO: Reading the /etc/sysconfig/SuSEfirewall2 file
```

```

INFO: Ensuring all firewall services are in a well-known state.
INFO: This will start/stop/restart firewall services and it's likely
INFO: to cause network disruption.
INFO: If you do not wish for this to happen, please stop the script now!
5...4...3...2...1...Lets do it!
INFO: Stopping firewalld
INFO: Restarting SuSEfirewall2_init
INFO: Restarting SuSEfirewall2
INFO: DIRECT: Adding direct rule="ipv4 -t filter -A INPUT -p udp -m udp --dport 5353 -m
pktttype
--pkt-type multicast -j ACCEPT"
[...]
INFO: Enabling direct rule=ipv6 -t filter -A INPUT -p udp -m udp --dport 546 -j ACCEPT
INFO: Enabling direct rule=ipv6 -t filter -A INPUT -p udp -m udp --dport 5353 -m pktttype
--pkt-type multicast -j ACCEPT
INFO: Enable logging for denied packets
INFO: #####
INFO:
INFO: The dry-run has been completed. Please check the above output to ensure
INFO: that everything looks good.
INFO:
INFO: #####
INFO: Stopping firewalld
INFO: Restarting SuSEfirewall2_init
INFO: Restarting SuSEfirewall2

```

This results in a lot of output, which you may wish to direct to a file for easier review:

```
# susefirewall2-to-firewalld | tee newfirewallrules.txt
```

The script supports these options:

-c

Commit changes. The script makes changes to the system, so make sure you only use this option if you are really happy with the proposed changes. This *will* reset your current firewalld configuration, so make sure you make backups!

-d

Super noisy. Use it to file bug reports but be careful to mask sensitive information.

-h

This message.

-q

No output. Errors will not be printed either!

-v

Verbose mode. It will print warnings and other informative messages.

23.6 More information

The most up-to-date information and other documentation about the `firewalld` package is found in `/usr/share/doc/packages/firewalld`. The home page of the netfilter and iptables project, <https://www.netfilter.org>, provides a large collection of documents about iptables in general in many languages.

24 Configuring a VPN server

Internet connections are easily available and affordable. However, not all connections are secure. Using a Virtual Private Network (VPN), you can create a secure network within an insecure network such as the Internet or Wi-Fi. It can be implemented in different ways and serves several purposes. In this chapter, we focus on the [OpenVPN \(https://openvpn.net\)](https://openvpn.net) implementation to link branch offices via secure wide area networks (WANs).

24.1 Conceptual overview

This section defines some terms regarding VPN and gives a brief overview of some scenarios.

24.1.1 Terminology

Endpoint

The two “ends” of a tunnel, the source or destination client.

Tap device

A tap device simulates an Ethernet device (layer 2 packets in the OSI model, such as Ethernet frames). A tap device is used for creating a network bridge. It works with Ethernet frames.

Tun device

A tun device simulates a point-to-point network (layer 3 packets in the OSI model, such as IP packets). A tun device is used with routing and works with IP frames.

Tunnel

Linking two locations through a primarily public network. From a more technical viewpoint, it is a connection between the client's device and the server's device. A tunnel is encrypted, but it does need to be by definition.

24.1.2 VPN scenarios

Whenever you set up a VPN connection, your IP packets are transferred over a secured *tunnel*. A tunnel can use either a *tun* or *tap* device. They are virtual network kernel drivers which implement the transmission of Ethernet frames or IP frames/packets.

Any user space program, such as OpenVPN, can attach itself to a *tun* or *tap* device to receive packets sent by your operating system. The program is also able to write packets to the device. There are many solutions to set up and build a VPN connection. This section focuses on the OpenVPN package. Compared to other VPN software, OpenVPN can be operated in two modes:

Routed VPN

Routing is an easy solution to set up. It is more efficient and scales better than a bridged VPN. Furthermore, it allows the user to tune MTU (Maximum Transfer Unit) to raise efficiency. However, in a heterogeneous environment, if you do not have a Samba server on the gateway, NetBIOS broadcasts do not work. If you need IPv6, the drivers for the *tun* devices on both ends must support this protocol explicitly. This scenario is depicted in [Figure 24.1, "Routed VPN"](#).

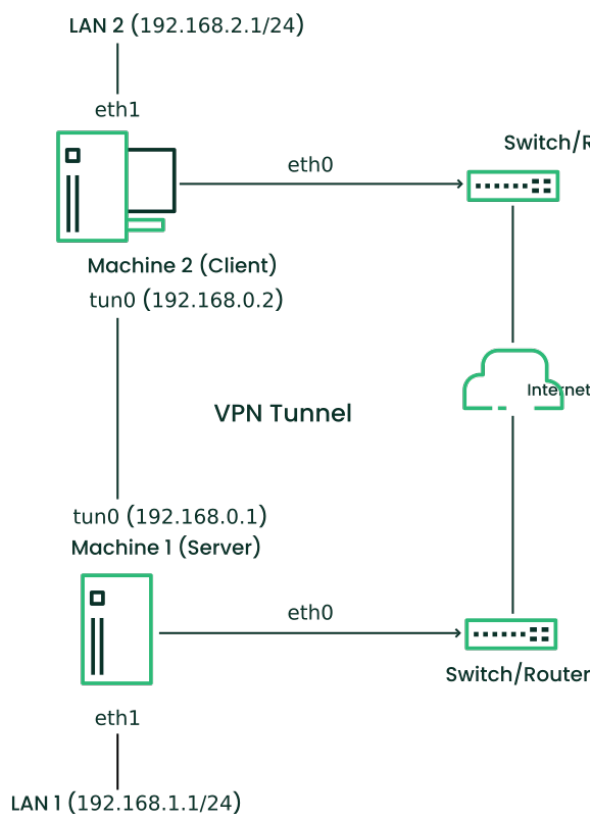

FIGURE 24.1: ROUTED VPN

Bridged VPN

Bridging is a more complex solution. It is recommended when you need to browse Windows file shares across the VPN without setting up a Samba or WINS server. Bridged VPN is also needed to use non-IP protocols (such as IPX) or applications relying on network broadcasts. However, it is less efficient than routed VPN. Another disadvantage is that it does not scale well. This scenario is depicted in the following figures.

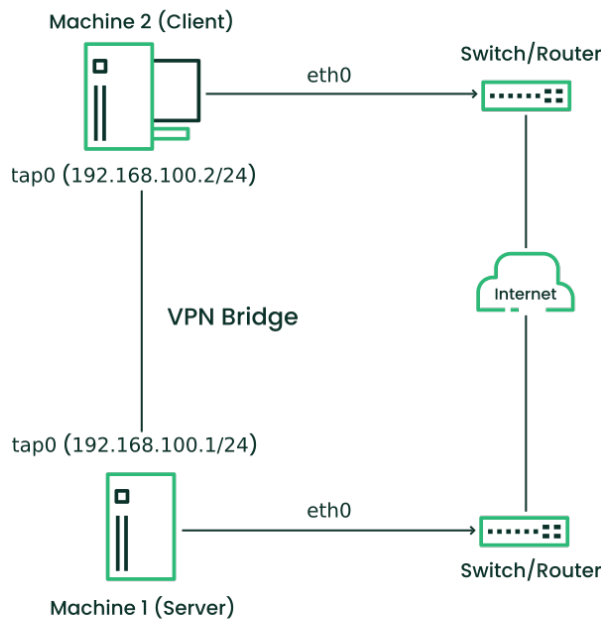

FIGURE 24.2: BRIDGED VPN - SCENARIO 1

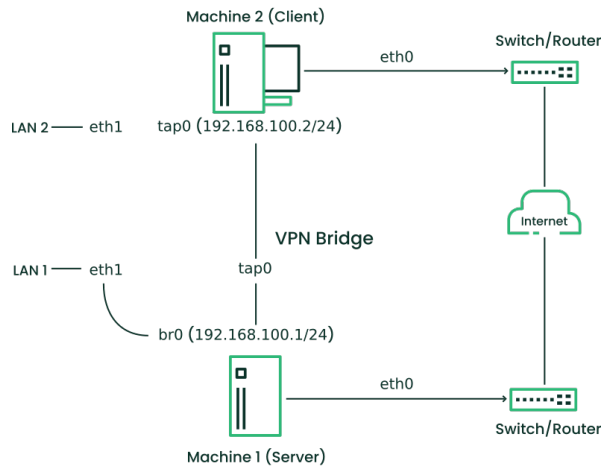

FIGURE 24.3: BRIDGED VPN - SCENARIO 2

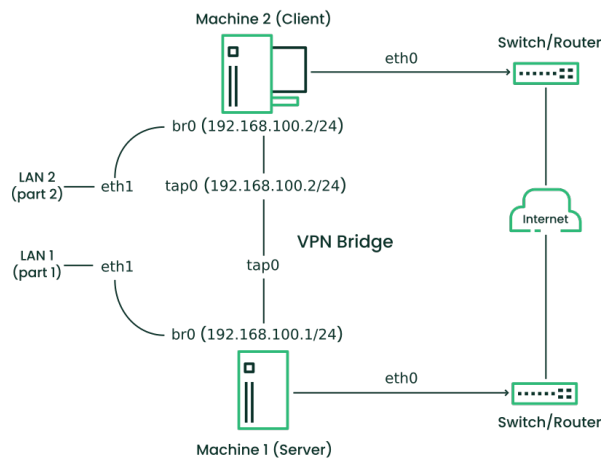

FIGURE 24.4: BRIDGED VPN - SCENARIO 3

The major difference between bridging and routing is that a routed VPN cannot IP-broadcast while a bridged VPN can.

24.2 Setting up a simple test scenario

In the following example, we create a point-to-point VPN tunnel. The example demonstrates how to create a VPN tunnel between one client and a server. It is assumed that your VPN server uses private IP addresses like `IP_OF_SERVER` and your client uses the IP address `IP_OF_CLIENT`. Make sure you select addresses which do not conflict with other IP addresses.



Warning: Use only for testing

This following scenario is provided as an example meant for familiarizing yourself with VPN technology. *Do not* use this as a real world scenario, as it can compromise the security and safety of your IT infrastructure.



Tip: Names for configuration file

To simplify working with OpenVPN configuration files, we recommend the following:

- Place your OpenVPN configuration files in the directory `/etc/openvpn`.
- Name your configuration files `MY_CONFIGURATION.conf`.
- If there are multiple files that belong to the same configuration, place them in a subdirectory like `/etc/openvpn/MY_CONFIGURATION`.

24.2.1 Configuring the VPN server

To configure a VPN server, proceed as follows:

PROCEDURE 24.1: VPN SERVER CONFIGURATION

1. Install the package `openvpn` on the machine that later becomes your VPN server.
2. Open a shell, become `root` and create the VPN secret key:

```
# openvpn --genkey secret /etc/openvpn/secret.key
```

3. Copy the secret key to your client:

```
# scp /etc/openvpn/secret.key root@IP_OF_CLIENT:/etc/openvpn/
```

4. Create the file `/etc/openvpn/server.conf` with the following content:

```
dev tun
ifconfig IP_OF_SERVER IP_OF_CLIENT
secret secret.key
```

5. Set up a tun device configuration by creating a file called `/etc/sysconfig/network/ifcfg-tun0` with the following content:

```
STARTMODE='manual'
BOOTPROTO='static'
TUNNEL='tun'
TUNNEL_SET_OWNER='nobody'
TUNNEL_SET_GROUP='nobody'
LINK_REQUIRED=no
PRE_UP_SCRIPT='systemd:openvpn@server'
PRE_DOWN_SCRIPT='systemd:openvpn@service'
```

The notation `openvpn@server` points to the OpenVPN server configuration file located at `/etc/openvpn/server.conf`. For more information, see `/usr/share/doc/packages/openvpn/README.SUSE`.

6. If you use a firewall, start YaST and open UDP port 1194 (*Security and Users > Firewall > Allowed Services*).
7. Start the OpenVPN server service by setting the tun device to `up`:

```
> sudo wicked ifup tun0
```

You should see the confirmation:

```
tun0          up
```

24.2.2 Configuring the VPN clients

To configure the VPN client, do the following:

PROCEDURE 24.2: VPN CLIENT CONFIGURATION

1. Install the package `openvpn` on your client VPN machine.
2. Create `/etc/openvpn/client.conf` with the following content:

```
remote DOMAIN_OR_PUBLIC_IP_OF_SERVER
```

```
dev tun
ifconfig IP_OF_CLIENT IP_OF_SERVER
secret secret.key
```

Replace the placeholder `IP_OF_CLIENT` in the first line with either the domain name, or the public IP address of your server.

3. Set up a tun device configuration by creating a file called `/etc/sysconfig/network/ifcfg-tun0` with the following content:

```
STARTMODE='manual'
BOOTPROTO='static'
TUNNEL='tun'
TUNNEL_SET_OWNER='nobody'
TUNNEL_SET_GROUP='nobody'
LINK_REQUIRED=no
PRE_UP_SCRIPT='systemd:openvpn@client'
PRE_DOWN_SCRIPT='systemd:openvpn@client'
```

4. If you use a firewall, start YaST and open UDP port 1194 as described in [Step 6 of Procedure 24.1, "VPN server configuration"](#).
5. Start the OpenVPN server service by setting the tun device to `up`:

```
> sudo wicked ifup tun0
```

You should see the confirmation:

```
tun0          up
```

24.2.3 Testing the VPN example scenario

After OpenVPN has successfully started, test the availability of the tun device with the following command:

```
ip addr show tun0
```

To verify the VPN connection, use `ping` on both client and server side to see if they can reach each other. Ping the server from the client:

```
ping -I tun0 IP_OF_SERVER
```

Ping the client from the server:

```
ping -I tun0 IP_OF_CLIENT
```

24.3 Setting up your VPN server using a certificate authority

The example in [Section 24.2](#) is useful for testing, but not for daily work. This section explains how to build a VPN server that allows more than one connection at the same time. This is done with a public key infrastructure (PKI). A PKI consists of a pair of public and private keys for the server and each client, and a certificate authority (CA), which is used to sign every server and client certificate.

This setup involves the following basic steps:

1. [Section 24.3.1, "Creating certificates"](#)
2. [Section 24.3.2, "Configuring the VPN server"](#)
3. [Section 24.3.3, "Configuring the VPN clients"](#)

24.3.1 Creating certificates

Before a VPN connection can be established, the client must authenticate the server certificate. Conversely, the server must also authenticate the client certificate. This is called *mutual authentication*.

Creating certificates is not supported on SUSE Linux Enterprise Server. The following assumes you have created a CA certificate, a server certificate, and a client certificate on another system. The server certificate is required in the PEM and unencrypted key in PEM formats. Copy the PEM version to `/etc/openvpn/server_cert.pem` on the VPN server. The unencrypted version needs to go to `/etc/openvpn/server_key.pem`.

Client certificates need to be of the format PKCS12 (preferred) or PEM. The certificate in PKCS12 format needs to contain the CA chain and needs to be copied to `/etc/openvpn/CLIENT.p12`. In case you have client certificates in PEM format containing the CA chain, copy them to `/etc/openvpn/CLIENT.pem`. In case you have split the PEM certificates into client certificate (`*.ca`), client key (`*.key`), and the CA certificate (`*.ca`), copy these files to `/etc/openvpn/` on each client.

The CA certificate needs to be copied to `/etc/openvpn/vpn_ca.pem` on the server and each client.

! Important: Splitting client certificates

If you split client certificates into client certificate, client key, and the CA certificate, you need to provide the respective file names in the OpenVPN configuration file on the respective clients (see *Example 24.1, “VPN server configuration file”*).

24.3.2 Configuring the VPN server

As the basis of your configuration file, copy `/usr/share/doc/packages/openvpn/sample-config-files/server.conf` to `/etc/openvpn/`. Then customize it to your needs.

EXAMPLE 24.1: VPN SERVER CONFIGURATION FILE

```
# /etc/openvpn/server.conf
port 1194 ①
proto udp ②
dev tun0 ③

# Security ④

ca    vpn_ca.pem
cert  server_cert.pem
key   server_key.pem

# ns-cert-type server
remote-cert-tls client ⑤
dh    server/dh2048.pem ⑥

server 192.168.1.0 255.255.255.0 ⑦
ifconfig-pool-persist /var/run/openvpn/ipp.txt ⑧

# Privileges ⑨
user nobody
group nobody

# Other configuration ⑩
keepalive 10 120
comp-lzo
persist-key
persist-tun
# status      /var/log/openvpn-status.tun0.log ⑪
# log-append  /var/log/openvpn-server.log ⑫
verb 4
```

- ❶ The TCP/UDP port on which OpenVPN listens. You need to open the port in the firewall, see *Chapter 23, Masquerading and firewalls*. The standard port for VPN is 1194, so you can leave that as it is.
- ❷ The protocol, either UDP or TCP.
- ❸ The tun or tap device. For the difference between these, see *Section 24.1.1, “Terminology”*.
- ❹ The following lines contain the relative or absolute path to the root server CA certificate (`ca`), the root CA key (`cert`), and the private server key (`key`). These were generated in *Section 24.3.1, “Creating certificates”*.
- ❺ Require that peer certificates have been signed with an explicit key usage and extended key usage based on RFC3280 TLS rules.
- ❻ The Diffie-Hellman parameters. Create the required file with the following command:

```
openssl dhparam -out /etc/openvpn/dh2048.pem 2048
```

- ❼ Supplies a VPN subnet. The server can be reached by `192.168.1.1`.
- ❽ Records a mapping of clients and its virtual IP address in the given file. Useful when the server goes down and (after the restart) the clients get their previously assigned IP address.
- ❾ For security reasons, run the OpenVPN daemon with reduced privileges. To do so, specify that it should use the group and user `nobody`.
- ❿ Several configuration options—see the comment in the example configuration file: `/usr/share/doc/packages/openvpn/sample-config-files`.
- ⓫ Enable this option to write short status updates with statistical data (“operational status dump”) to the named file. By default, this is not enabled.
All output is written to the system journal, which can be displayed with `journalctl`. If you have more than one configuration file (for example, one for home and another for work), it is recommended to include the device name into the file name. This avoids overwriting output files accidentally. In this case, it is `tun0`, taken from the `dev` directive—see ❸.
- ⓬ By default, log messages go to syslog. Overwrite this behavior by removing the hash character. In that case, all messages go to `/var/log/openvpn-server.log`. Do not forget to configure a logrotate service. See **man 8 logrotate** for further details.

After having completed this configuration, you can see log messages of your OpenVPN server under `/var/log/openvpn.log`. After having started it for the first time, it should finish with:

```
... Initialization Sequence Completed
```

If you do not see this message, check the log carefully for any hints of what is wrong in your configuration file.

24.3.3 Configuring the VPN clients

As the basis of your configuration file, copy `/usr/share/doc/packages/openvpn/sample-config-files/client.conf` to `/etc/openvpn/`. Then customize it to your needs.

EXAMPLE 24.2: VPN CLIENT CONFIGURATION FILE

```
# /etc/openvpn/client.conf
client ❶
dev tun ❷
proto udp ❸
remote IP_OR_HOST_NAME 1194 ❹
resolv-retry infinite
nobind

remote-cert-tls server ❺

# Privileges ❻
user nobody
group nobody

# Try to preserve some state across restarts.
persist-key
persist-tun

# Security ❼
pkcs12 client1.p12

comp-lzo ❸
```

- ❶ Specifies that this machine is a client.
- ❷ The network device. Both clients and server must use the same device.
- ❸ The protocol. Use the same settings as on the server.
- ❺ This is security option for clients which ensures that the host they connect to is a designated server.
- ❹ Replace the placeholder `IP_OR_HOST_NAME` with the respective host name or IP address of your VPN server. After the host name, the port of the server is given. You can have multiple lines of `remote` entries pointing to different VPN servers. This is useful for load balancing between different VPN servers.

- ⑥ For security reasons, run the OpenVPN daemon with reduced privileges. To do so, specify that it should use the group and user `nobody`.
- ⑦ Contains the client files. For security reasons, use a separate pair of files for each client.
- ⑧ Turn on compression. Only use this parameter if compression is enabled on the server as well.

24.4 Setting up a VPN server or client using YaST

You can also use YaST to set up a VPN server. However, the YaST module does not support OpenVPN. Instead, it provides support for the IPsec protocol (as implemented in the software StrongSwan). Like OpenVPN, IPsec is a widely supported VPN scheme.

PROCEDURE 24.3: SETTING UP AN IPSEC SERVER

1. To start the YaST VPN module, select *Applications > VPN Gateways and Clients*.
2. Under *Global Configuration*, activate *Enable VPN Daemon*.
3. To create a new VPN, click *New VPN*, then enter a name for the connection.
4. Under *Type*, select *Gateway (Server)*.
5. Then choose the scenario:
 - The scenarios *Secure communication with a pre-shared key* and *Secure communication with a certificate* are best suited to Linux client setups.
 - The scenario *Provide access to Android, iOS, Mac OS X clients* sets up a configuration that is natively supported by modern versions of Android, iOS, and macOS. It is based on a pre-shared key setup with an additional user name and password authentication.
 - The scenario *Provide access to Windows 7, Windows 8 clients* is a configuration that is natively supported by Windows and BlackBerry devices. It is based on a certificate setup with an additional user name and password authentication.

For this example, choose *Secure communication with a pre-shared key*.

6. To specify the key, click *Edit Credentials*. Activate *Show key*, then type the secret key. Confirm with *OK*.

7. Choose whether and how to limit access within your VPN under *Provide VPN clients access to*. To enable only certain IP ranges, specify these in CIDR format, separated by commas in *Limited CIDRs*. For more information about the CIDR format, see https://en.wikipedia.org/wiki/Classless_Inter-Domain_Routing.
8. Under *Clients' address pool*, specify the format of IP addresses your VPN should provide to its clients.
9. To finish, click *OK*. The YaST VPN module automatically adds and enables firewall rules to allow clients to connect to the new VPN.
To view the connection status, in the following confirmation window, click *Yes*. You can see the output of `systemctl status` for your VPN, which allows you to check if the VPN is running and configured correctly.

24.5 More information

For more information about VPN, see:

- <https://openvpn.net>: the OpenVPN home page
- `man openvpn`
- `/usr/share/doc/packages/openvpn/sample-config-files/`: example configuration files for different scenarios.
- `/usr/src/linux/Documentation/networking/tuntap.txt`, to install the `kernel-source` package.

25 Managing a PKI with XCA, X certificate and key manager

Managing your own public key infrastructure (PKI) is traditionally done with the **openssl** utility. For admins who prefer a graphical tool, SUSE Linux Enterprise Server 15 SP6 includes XCA, the X Certificate and Key management tool (<https://hohnstaedt.de/xca>).

XCA creates and manages X.509 certificates, certificate requests, RSA, DSA and EC private keys, Smartcards and certificate revocation lists (CRLs). XCA supports everything you need to create and manage your own certificate authority (CA). XCA includes customizable templates that can be used for certificate or request generation. This chapter describes a basic setup.

25.1 Installing XCA

XCA is provided by the `xca` package:

```
> sudo zypper in xca
```

25.2 Creating a new PKI

XCA stores all cryptographic data in a database. When you are using XCA for the first time, and creating a new PKI, you must first create a new database by clicking *File > New DataBase* (Figure 25.1, “Create a new XCA database”).

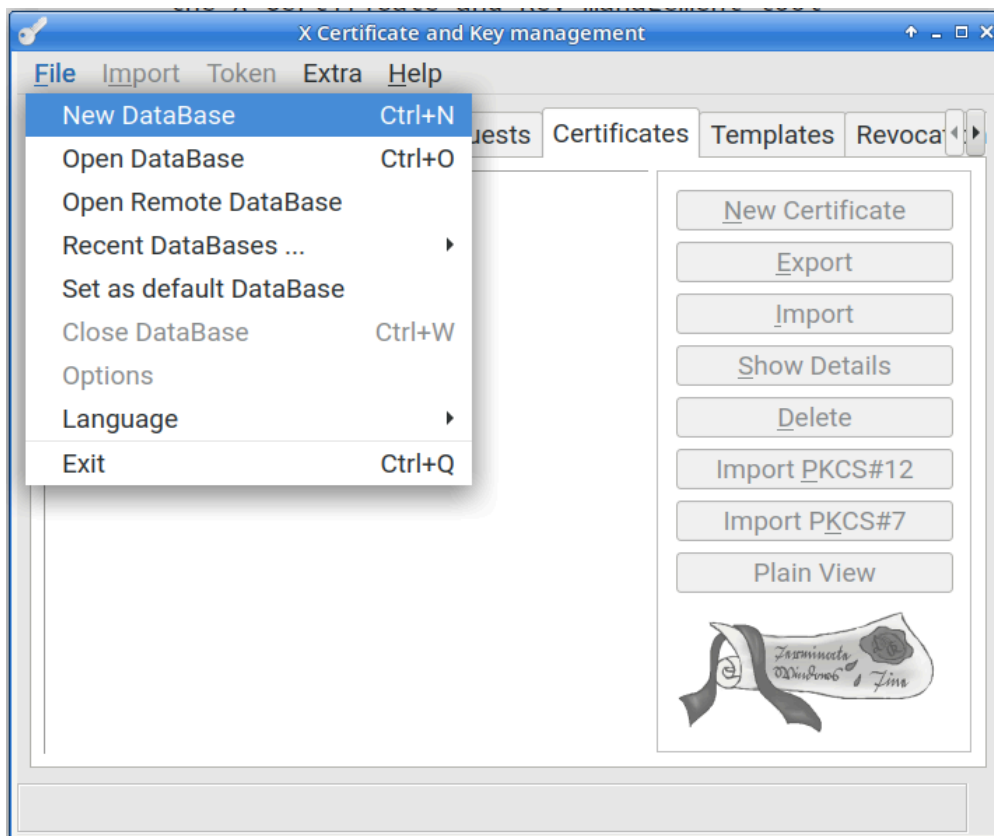

FIGURE 25.1: CREATE A NEW XCA DATABASE

25.2.1 Creating a new root CA

The following steps describe how to create a new root CA.

1. Click the *Certificates* tab.
2. Click the *New Certificate* button.
3. Click the *Source* tab. At the bottom of the window, under *Template for the new certificate*, select the *[default] CA* template, then click *Apply all*.
4. Click the *Subject* tab. Create an *Internal Name*, which identifies your new root CA internally, in XCA only.
Complete the fields in the *Distinguished Name* section. Use the *Add* button to add any additional elements, if you require any.
5. In the *Private key* drop-down, select your preferred private key if you have one, or generate a new key.

6. Click the *Extensions* tab. Edit any attributes as necessary. The default *Time Range* is 10 years. The certificate revocation list distribution point is part of the issued certificates, and it is a good practice to use a common URL for all your certificates, for example, <http://www.example.com/crl/crl.der>. When you are finished click the *OK* button.

25.2.2 Creating a signed host certificate

The next step is to create a host certificate signed by your new certificate authority.

1. Click the *Certificates* tab, then click the *New Certificate* button.
2. On the *Source* tab, select the *[default] TLS_server* and click the *Apply all* button. This enters the appropriate values in the *Extensions*, *Key usage*, and *Netscape* tabs. In the *Signing* section, select the certificate that you created in [Section 25.2.1, "Creating a new root CA"](#).
3. Click the *Subject* tab. Create an internal name, which is for display purposes in XCA. A good practice is to use the host name, or the fully qualified domain name. Then fill in the fields in the *Distinguished Name* section. For host certificates, the common name must be the FQDN that your users use. This can be the canonical name of the host, or an alias. For example, if `jupiter.example.com` is your web server and it has a DNS CNAME entry of `www.example.com`, then you want the *commonName* value in the certificate to be `www.example.com`. To add any additional parts to the distinguished name, use the drop-down box and *Add* button. Select the desired private key or generate a new one.
4. Click the *Extensions* tab. The default *Time range* is one year. If you change this, click the *Apply* button.
5. It is a good practice to designate a certificate revocation list location. The location must be unique for this root certificate. XCA exports CRLs in either PEM or DER format with appropriate suffixes, so this should be considered when selecting the URL, for example something like <http://www.example.com/crl/crl.der>. On the *CRL Distribution points* line click the *Edit* button. Type in your URI, then click *Add*. Click *Validate* and *Apply*. Click the *OK* button.

25.2.3 Revoking a certificate

1. Click the *Certificates* tab.

2. Right-click the certificate that you want to revoke, then click *Revoke*.
3. Right-click the CA certificate that signed the certificate you want to revoke. Click *CA > Generate CRL*.
Click the *OK* button in the *Create CRL* dialog.
4. Click the *Revocation lists* tab in the main window. Right-click the CRL you just generated and select *Export*. Select the desired format (DER) and click *OK*.
Copy the exported CRL to the location published in the issued certificate's *CRL Distribution Points*.

26 Improving network security with `sysctl` variables

`Sysctl` (system control) variables control certain kernel parameters that influence the behavior of different parts of the operating system, for example the Linux network stack. These parameters can be looked up in the `proc` file system, in `/proc/sys`. Many kernel parameters can be changed directly by writing a new value into a parameter pseudo file. However, these changes are not persisted and are lost after a system reboot. Therefore, we recommend configuring all changes in a `sysctl` configuration file to have them applied at every system start.

In this chapter, several networking related variables are configured that improve the security features of Linux. Depending on the presence of a firewall and its settings, certain variables listed here already have the safe values by default. You can check the current value of a setting by using the `sysctl` utility like this:

```
> /sbin/sysctl net.ipv4.conf.all.rp_filter
net.ipv4.conf.all.rp_filter = 2
```

To apply the following settings, create a configuration file `/etc/sysctl.d/`. The file needs to end with a `.conf` suffix, for example `/etc/sysctl.d/network.conf`. For details, refer to [man 5 sysctl.d](#).

Set the variables from the following list as appropriate for your environment.

- ```
the default setting for this is 2 (loose mode)
net.ipv4.conf.default.rp_filter = 1
net.ipv4.conf.all.rp_filter = 1
```

This setting enables the IPv4 reverse path filter in strict mode. It ensures that answers to incoming IP packets are always sent out via the interface from that the packets have been received. If the system would direct answer packets to a different outgoing interface according to the routing table, these packets would be discarded. The setting prevents certain kinds of IP spoofing attacks that are, for example, used for distributed denial-of-service (DDoS) attacks.

- ```
# the default setting for this should already be 0
net.ipv4.conf.default.accept_source_route = 0
net.ipv4.conf.all.accept_source_route = 0
```

This setting disables the acceptance of packets with the `SSR` option set in the IPv4 packet header. Packets that use *Source Routing* are rejected. This prevents IP packet redirection, that is redirection to a host behind a firewall, that is not directly reachable otherwise.

- ```
the default setting for this should already be 1
net.ipv4.tcp_syncookies = 1
```

This enables TCP SYN Cookie Protection for IPv4 *and* IPv6. It addresses a specific denial-of-service attack on the TCP protocol level. The protection involves a small CPU trade-off in favor of avoiding memory exhaustion caused by attackers. The protection mechanism consists of a fallback algorithm that only comes into play when no further TCP connections can be accepted the normal way. The mechanism is not fully TCP protocol compliant and can thus cause protocol issues in certain TCP contexts. The alternative would be to drop additional connections in overload scenarios. This also needs a differentiation between legitimate high TCP load and a TCP denial-of-service attack. If you expect a high load of TCP connections on your system, then this setting could be counterproductive.

- ```
# default is 128
net.ipv4.tcp_max_syn_backlog = 4096
```

The TCP SYN backlog defines the number of SYN packets that are queued for further processing. Once the queue limit is exceeded, all new incoming SYN-packets are dropped and new TCP connections are not possible (or the SYN cookie protection kicks in). Increasing this value improves the protection against TCP SYN flood attacks.

- ```
the default setting for this should already be 1
net.ipv4.icmp_echo_ignore_broadcasts = 1
```

ICMP echo requests (ping) can be sent to an IPv4 broadcast address in order to scan a network for existing hosts / IP addresses or to perform an ICMP flood within a network segment. This setting causes the networking stack to ignore ICMP echo packets sent to a broadcast address.

- ```
# the default setting for this should already be 1
net.ipv4.icmp_ignore_bogus_error_responses = 1
```

This setting avoids filling up log files with unnecessary error messages coming from invalid responses to broadcast frames. Refer to *RFC 1122 Requirements for Internet Hosts -- Communication Layers Section 3.2.2* (<https://datatracker.ietf.org/doc/html/rfc1122#section-3.2.2>) [↗](#) for more information.

- ```
default should already be 0
net.ipv4.conf.default.accept_redirects = 0
net.ipv4.conf.all.accept_redirects = 0
net.ipv6.conf.default.accept_redirects = 0
```

```
net.ipv6.conf.all.accept_redirects = 0
```

Disables the acceptance of ICMP redirect messages. These messages are sent by gateways to inform a host about a better route to an outside network. These redirects can be misused for man-in-the-middle attacks.

- ```
net.ipv4.conf.default.secure_redirects = 0  
net.ipv4.conf.all.secure_redirects = 0
```

Accepting 'secure' ICMP redirects (from those gateways listed as default gateways) has few legitimate uses. It should be disabled unless it is absolutely required.

- ```
net.ipv4.conf.default.send_redirects = 0
net.ipv4.conf.all.send_redirects = 0
```

A node should not send IPv4 ICMP redirects, unless it acts as a router.

- ```
# default should already be 0  
net.ipv4.ip_forward = 0  
net.ipv6.conf.all.forwarding = 0  
net.ipv6.conf.default.forwarding = 0
```

IP forwarding should only be enabled on systems acting as routers.

IV Regulations and compliance

- 27 Common Criteria **306**
- 28 Enabling compliance with FIPS 140-3 **311**
- 29 Payment Card Industry Data Security Standard (PCI DSS) **315**
- 30 Hardening SUSE Linux Enterprise with STIG **316**

27 Common Criteria

Common Criteria is the best known and most widely used methodology to evaluate and measure the security value of an IT product. The methodology aims to be independent, as an independent laboratory conducts the evaluation, which a certification body certifies afterward. Security Functional Requirements (SFR) are summarized in so-called Protection Profiles (PP). If the definition of a Security Target (ST) and the Evaluation Assurance Levels (EAL) are comparable, this allows the comparison of security functions of different products. (The definition of a Security Target typically references the PP—if one exists that fits the purpose of the product.)

27.1 Introduction

A clear definition of security in IT products is challenging. Security should be considered a process that never ends, not a static condition that can be met or not. A Common Criteria certificate (below EAL7) does not make a clear statement about the error-proneness of the system, but it adds an important value to the product that cannot be described with the presence of technology alone: that someone has independently inspected the design of the system in such a way that it corresponds to the claims that are made, and that explicit care has been taken in producing and maintaining the product.

The certificate states a degree of maturity of both the product with its security functions and the processes of the company that designed, built and engineered the product, and that maintains the product across its lifecycle. As such, Common Criteria aims to be holistic with its approach to take everything into account that is relevant for the security of an IT product.

27.2 Evaluation Assurance Level (EAL)

The Evaluation Assurance Level denotes the degree of confidence that the product fulfills the described claims. The levels are from 1 through 7:

- EAL1: Functionally tested
- EAL2: Structurally tested
- EAL3: Methodically tested and checked
- EAL4: Methodically designed, tested and reviewed

- EAL5: Semi-formally designed and tested
- EAL6: Semi-formally verified design and tested
- EAL7: Formally verified design and tested

While EAL1 only provides basic assurance for products to meet security requirements, EAL2 to EAL4 are medium assurance levels. EAL5 to EAL7 describe medium-to-high and high assurance. EAL4 is expected to be the highest level of assurance that a product can have, if it has not been designed from the start to achieve a higher level of assurance.

27.3 Generic guiding principles

Much of the advice in this guide is based on the following guidelines. Consider them when defining your own security processes or deciding about configurations that are not explicitly covered here.

Use data encryption whenever possible

Be aware that cryptography is certainly useful, but only for the specific purposes that it is good for. Using cryptography is not a generic recipe for better security in a system; its use may even impose additional risk on the system. Make informed decisions about the use of cryptography, and feel obliged to have a reason for your decisions. A false sense of security can be more harmful than the weakness itself.

SUSE Linux Enterprise Server supports encryption for:

- Network connections (the `openssl` command, `stunnel`), for remote login (`openssh`, `man ssh(1)`)
- Files (`gpg`)
- Entire file systems at block layer (`dm-crypt`, `cryptsetup`)
- VPN (`ipsec`, `openvpn`)

Minimal package installation

It is useful to restrict the installed packages in your system to a minimum. Binaries not installed cannot be executed.

During installation of the system, you can limit the set of packages that is installed. For example, you can deselect all packages and select only those that you want to use. For example, the selection of the `apache2-mod_perl` package in YaST would automatically

cause all packages to be selected for installation that are needed for the Apache package to operate. Dependencies have often been artificially cut down to handle the system's dependency tree more flexibly. You can choose the minimal system, and build the dependency tree from there with your (leaf) package selection.

Service isolation—run different services on separate systems

Whenever possible, a server should be dedicated to serving exactly one service or application. This limits the number of other services that could be compromised if an attacker can successfully exploit a software flaw in one service (assuming that flaw allows access to others).

The use of AppArmor for services that are provided on a system is an effective means of containment. For more information, see [Part V, “Confining privileges with AppArmor”](#) and the man page of `apparmor`.

The use of virtualization technology is supported with SUSE Linux Enterprise Server. While virtualization is generally designed for server consolidation purposes, it is also useful for service isolation. However, virtualization technology *cannot* match or substitute the separation strength that is given by running services on different physical machines. Be aware that the capability of the hypervisor to separate virtual machines is not higher or stronger than the Linux kernel's capability to separate processes and their address spaces.

System fingerprinting and backups

Doing regular backups and having a fingerprint of your system is vital, especially in the case of a successful attack against your system. Make it an integral part of your security routine to verify that your backups work.

A fast and directly accessible backup adds confidence about the integrity of your system. However, it is important that the backup mechanism/solution has adequate versioning support so that you can trace changes in the system. As an example: The installation times of packages (`rpm -q --queryformat='%{INSTALLTIME} %{NAME}\n' PACKAGE NAME`) must correspond to the changed files in the backup log files.

Several tools exist on SUSE Linux Enterprise Server 15 SP6 that can be used for the detection of unknown, yet successful attacks. It does not take much effort to configure them.

In particular, we recommend using the file and directory integrity checker `AIDE` (Advanced Intrusion Detection Environment). When run for initialization, it creates a hash database of all files in the system, which are listed in its configuration file. This allows verifying the integrity of all cataloged files at a later time.



Warning: Backdoors

If you use AIDE, copy the hash database to a place that is inaccessible for potential attackers. Otherwise, the attacker may modify the integrity database after planting a backdoor, thereby defeating the purpose of the integrity measurement.

An attacker may also have planted a backdoor in the kernel. Apart from being hard to detect, the kernel-based backdoor can effectively remove all traces of the system compromise, so system alterations become almost invisible. Consequently, an integrity check needs to be done from a rescue system (or any other independent system with the target system's file systems mounted manually).

Be aware that the application of security updates invalidates the integrity database. `rpm -qlv packagename` lists the files that are contained in a package. The RPM subsystem is powerful with the data it maintains. It is accessible with the `--queryformat` command-line option. A differential update of the integrity database with the changed files becomes more manageable with fine-grained usage of RPM.

27.4 More information

The Common Criteria evaluations inspect a specific configuration of the product in an evaluated setup. How to install and configure the reference system that was used as baseline in the Common Criteria evaluation is documented in the “Administrator's Guide” part of the Common Criteria evaluation documentation.

However, it would be incorrect to understand the evaluated configuration as a *hardened* configuration. The removal of setuid bits and the prescription of administrative procedures after installation help to reach a specific configuration that is sane. But this is not sufficient for a hardening claim.

- For more information about SUSE Linux Enterprise Server security certifications and features, see <https://www.suse.com/support/security/certifications/>.
- Find a list of SUSE security resources at <https://www.suse.com/support/security/>.
- Apart from the documentation that comes with the Common Criteria effort, see also the following manual pages:

pam(8), pam(5)

apparmor(7) and referenced man pages
rsyslogd(8), syslog(8), syslogd(8)
fstab(5), mount(8), losetup(8), cryptsetup(8)
haveged(8), random(4)
ssh(1), sshd(8), ssh_config(5), sshd_config(5), ssh-agent(1), ssh-add(1), ssh-keygen(1)
cron(1), crontab(5), at(1), atd(8)
systemctl(1), daemon(7), systemd.unit(5), systemd.special(5), kernel-command-line(7),
bootup(7), systemd.directives

28 Enabling compliance with FIPS 140-3

FIPS 140-3 is a security accreditation program for validating cryptographic modules produced by private companies. The Federal Information Processing Standards (FIPS) Publication 140 is a series of computer security standards developed by the National Institute of Standards and Technology (NIST) to ensure the quality of cryptographic modules.

If your organization does any work for the United States federal government, your cryptography applications (such as openssl, GnuTLS and OpenJDK) may be required to comply with Federal Information Processing Standards (FIPS) 140-3. If your organization is not required by compliance rules to run SUSE Linux Enterprise in FIPS mode, it is best to not do it. This chapter provides guidance on enabling FIPS mode, and links to resources with detailed information.



Important: SUSE Linux Enterprise Server 15 SP6 and FIPS 140-3

The relevant binaries are currently undergoing FIPS 140-3 certification. Until the certification has been achieved, full FIPS 140-3 compliance cannot be guaranteed.

28.1 FIPS overview

Every vendor that develops and maintains cryptographic applications and wants them to be tested for FIPS compliance must submit them to the Cryptographic Module Validation Program (CMVP) (see <https://csrc.nist.gov/projects/cryptographic-module-validation-program> ↗).

The latest FIPS 140-3 standard was approved in March 2019 and replaces 140-2.

28.2 When to enable FIPS mode



Warning: FIPS requires expertise

Administering FIPS is complex and requires significant expertise. Implementing it correctly, testing and troubleshooting all require a high degree of knowledge.

Only run your SLES in FIPS mode when it is required to meet compliance rules. Otherwise, we do not recommend running your systems in FIPS mode.

Below are some reasons to *not* use FIPS mode (if not required explicitly):

- FIPS is restrictive. It enforces the use of specific validated cryptographic algorithms and specific certified binaries that implement these validated algorithms. You must use only the certified binaries.
- Upgrades may break functionality.
- The approval process is very long, so certified binaries are always several releases behind the newest release.
- Certified binaries, such as ssh, sshd and sftp-server, run their own self-checks at start-up and run only when these checks succeed. This creates a small performance degradation.
- Administering FIPS is complex and requires significant expertise.

28.3 Installing FIPS

It is best to install the `patterns-base-fips` pattern on a new installation.



Important: Unstable packages

The relevant binaries are currently undergoing FIPS 140-3 certification. Until the certification has been achieved, full FIPS 140-3 compliance cannot be guaranteed.

You may install `patterns-base-fips` and enable FIPS mode on a running system, you may have to make adjustments, such as regenerating keys and auditing your setup to ensure it is set up correctly.

28.4 Enabling FIPS mode

The following procedure shows you how to enable FIPS mode:

1. The `crypto-policies-scripts` package that provides the `fips-mode-setup` command might not be installed by default. If it is not, you can install the package in a supported way and then enable the kernel FIPS mode, which also sets the system policy to FIPS:

```
> sudo fips-mode-setup --enable
Setting system policy to FIPS
FIPS mode will be enabled.
[...]
Please reboot the system for the setting to take effect.
```

2. Reboot and verify the FIPS mode with:

```
> sudo fips-mode-setup --check
FIPS mode is enabled.
Initramfs fips module is enabled.
The current crypto policy (FIPS) is based on the FIPS policy.
```

3. To disable FIPS mode, run:

```
> sudo fips-mode-setup --disable
Setting system policy to DEFAULT
FIPS mode will be disabled.
[...]
Please reboot the system for the setting to take effect.
```

You can also use the following options:

- `--no-bootcfg`: The tool does not reconfigure the boot loader but instead prints the options that need to be added to the kernel command line. Exception: It still attempts to execute `zipl` on `s390x`, as the system might become unbootable otherwise.
- `--is-enabled`: Checks the system FIPS mode status and returns a failure error code if disabled (2) or inconsistent (1).

28.5 MD5 not supported in Samba/CIFS

According to the FIPS standards, MD5 is not a secure hashing algorithm, and it must not be used for authentication. If you run a FIPS-compliant network environment, and you have clients or servers that run in FIPS-compliant mode, you must use a Kerberos service for authenticating Samba/CIFS users. This is necessary as all other Samba authentication modes include MD5.

See the Samba section of the Storage Administration Guide for more information on running a Samba server.

28.6 More information

For more information, refer to:

- Man 8 [fips-mode-setup](#)
- Man 8 [fips-finish-install](#)
- Man 7 [crypto-policies](#)
- Man 8 [update-crypto-policies](#)

29 Payment Card Industry Data Security Standard (PCI DSS)

To protect customers and the business itself, companies that handle credit card payments must keep data as safe and secure as possible. Following the Payment Card Industry Data Security Standard helps to secure all areas that are connected to payment processes, and to implement security-relevant actions to keep the data and the computing environment safe. For more information, see the Payment Card Industry Data Security Standard (PCI DSS) Guide (<https://documentation.suse.com/compliance/all/html/SLES-pci-dss/article-security-pcidss.html>)

30 Hardening SUSE Linux Enterprise with STIG

STIG stands for Security Technical Implementation Guide. The Defense Information Systems Agency (DISA) organization, which is a parent agency of the United States Department of Defense (DoD), approves and publishes Security Technical Implementation Guides (STIGs) and updates them every 90 days.

When a Security Technical Implementation Guide is implemented for a system, the system is hardened. The goals are to minimize attacks and to prevent system access (both physically and via a network) and to define processes for maintenance (applying software updates) and vulnerability patching. Security Technical Implementation Guides can also cover configuration settings, for example, for operating systems, routers, databases, firewall rules, domain name servers and switches.

For information on how to harden a SUSE Linux Enterprise system with STIG, see <https://documentation.suse.com/compliance/all/html/SLES-stig/article-stig.html> ↗.

V Confining privileges with AppArmor

- 31 Introducing AppArmor **318**
- 32 Getting started **320**
- 33 Immunizing programs **325**
- 34 Profile components and syntax **334**
- 35 AppArmor profile repositories **366**
- 36 Building and managing profiles with YaST **367**
- 37 Building profiles from the command line **377**
- 38 Profiling your Web applications using ChangeHat **404**
- 39 Confining users with pam_apparmor **415**
- 40 Managing profiled applications **416**
- 41 Support **418**
- 42 AppArmor glossary **427**

31 Introducing AppArmor

Many security vulnerabilities result from bugs in *trusted* programs. A trusted program runs with privileges that attackers want to possess. The program fails to keep that trust if there is a bug in the program that allows the attacker to acquire said privilege.

AppArmor® is an application security solution designed specifically to apply privilege confinement to suspect programs. AppArmor allows the administrator to specify the domain of activities the program can perform by developing a security *profile*. A security profile is a listing of files that the program may access and the operations the program may perform. AppArmor secures applications by enforcing good application behavior without relying on attack signatures, so it can prevent attacks even if previously unknown vulnerabilities are being exploited.

31.1 AppArmor components

AppArmor consists of:

- A library of AppArmor profiles for common Linux* applications, describing what files the program needs to access.
- A library of AppArmor profile foundation classes (profile building blocks) needed for common application activities, such as DNS lookup and user authentication.
- A tool suite for developing and enhancing AppArmor profiles, so that you can change the existing profiles to suit your needs and create new profiles for your own local and custom applications.
- Several specially modified applications that are AppArmor enabled to provide enhanced security in the form of unique subprocess confinement (including Apache).
- The AppArmor-related kernel code and associated control scripts to enforce AppArmor policies on your SUSE® Linux Enterprise Server system.

31.2 Background information on AppArmor profiling

For more information about the science and security of AppArmor, refer to the following papers:

SubDomain: Parsimonious Server Security by Crispin Cowan, Steve Beattie, Greg Kroah-Hartman, Calton Pu, Perry Wagle, and Virgil Gligor

Describes the initial design and implementation of AppArmor. Published in the proceedings of the USENIX LISA Conference, December 2000, New Orleans, LA. This paper is now out of date, describing syntax and features that are different from the current AppArmor product. This paper should be used only for background, and not for technical documentation.

Defcon Capture the Flag: Defending Vulnerable Code from Intense Attack by Crispin Cowan, Seth Arnold, Steve Beattie, Chris Wright, and John Viega

A good guide to strategic and tactical use of AppArmor to solve severe security problems in a short period of time. Published in the Proceedings of the DARPA Information Survivability Conference and Expo (DISCEX III), April 2003, Washington, DC.

AppArmor for Geeks by Seth Arnold

This document tries to convey a better understanding of the technical details of AppArmor. It is available at https://en.opensuse.org/SDB:AppArmor_geeks.

32 Getting started

Prepare a successful deployment of AppArmor on your system by carefully considering the following items:

1. Determine the applications to profile. Read more on this in [Section 32.3, “Choosing applications to profile”](#).
2. Build the needed profiles as roughly outlined in [Section 32.4, “Building and modifying profiles”](#). Check the results and adjust the profiles when necessary.
3. Update your profiles whenever your environment changes or you need to react to security events logged by the reporting tool of AppArmor. Refer to [Section 32.5, “Updating your profiles”](#).

32.1 Installing AppArmor

AppArmor is installed and running on any installation of SUSE® Linux Enterprise Server by default, regardless of what patterns are installed. The packages listed below are needed for a fully functional instance of AppArmor:

- [apparmor-docs](#)
- [apparmor-parser](#)
- [apparmor-profiles](#)
- [apparmor-utils](#)
- [audit](#)
- [libapparmor1](#)
- [perl-libapparmor](#)
- [yast2-apparmor](#)



Tip

If AppArmor is not installed on your system, install the pattern [apparmor](#) for a complete AppArmor installation. Either use the YaST Software Management module for installation, or use Zypper on the command line:

```
> sudo zypper in -t pattern apparmor
```

32.2 Enabling and disabling AppArmor

AppArmor is configured to run by default on any fresh installation of SUSE Linux Enterprise Server. There are two ways of toggling the status of AppArmor:

Using YaST services manager

Disable or enable AppArmor by removing or adding its boot script to the sequence of scripts executed on system boot. Status changes are applied on reboot.

Using AppArmor configuration window

Toggle the status of AppArmor in a running system by switching it off or on using the YaST AppArmor Control Panel. Changes made here are applied instantaneously. The Control Panel triggers a stop or start event for AppArmor and removes or adds its boot script in the system's boot sequence.

To disable AppArmor permanently (by removing it from the sequence of scripts executed on system boot) proceed as follows:

1. Start YaST.
2. Select *System > Services Manager*.
3. Mark apparmor by clicking its row in the list of services, then click *Enable/Disable* in the lower part of the window. Check that *Enabled* changed to *Disabled* in the apparmor row.
4. Confirm with *OK*.

AppArmor is not initialized on reboot and stays inactive until you re-enable it. Re-enabling a service using the YaST *Services Manager* tool is similar to disabling it.

Toggle the status of AppArmor in a running system by using the AppArmor Configuration window. These changes take effect when you apply them and survive a reboot of the system. To toggle the status of AppArmor, proceed as follows:

1. Start YaST, select *AppArmor Configuration*, and click *Settings* in the main window.
2. Enable AppArmor by checking *Enable AppArmor* or disable AppArmor by deselecting it.
3. Click *Done* in the *AppArmor Configuration* window.

32.3 Choosing applications to profile

You need to protect the programs that are exposed to attacks in your particular setup, so use profiles for those applications you run. Use the following list to determine the candidates:

Network Agents

Web Applications

Cron Jobs

To find out which processes are currently running with open network ports and might need a profile to confine them, run `aa-unconfined` as `root`.

EXAMPLE 32.1: OUTPUT OF `aa-unconfined`

```
19848 /usr/sbin/cupsd not confined
19887 /usr/sbin/sshd not confined
19947 /usr/lib/postfix/master not confined
1328 /usr/sbin/smbd confined by '/usr/sbin/smbd (enforce)'
```

Each of the processes in the above example labeled `not confined` might need a custom profile to confine it. Those labeled `confined by` are already protected by AppArmor.



Tip: More information

For more information about choosing the right applications to profile, refer to [Section 33.2, “Determining programs to immunize”](#).

32.4 Building and modifying profiles

AppArmor on SUSE Linux Enterprise Server ships with a preconfigured set of profiles for the most important applications. Additionally, you can use AppArmor to create your own profiles for any application you want.

There are two ways of managing profiles. One is to use the graphical front-end provided by the YaST AppArmor modules and the other is to use the command-line tools provided by the AppArmor suite itself. The main difference is that YaST supports basic functionality for AppArmor profiles, while the command-line tools let you update/tune the profiles in a more fine-grained way.

For each application, perform the following steps to create a profile:

1. As `root`, let AppArmor create a rough outline of the application's profile by running `aa-genprof PROGRAM_NAME`.
or
Outline the basic profile by running *YaST > Security and Users > AppArmor Configuration > Manually Add Profile* and specifying the complete path to the application you want to profile.
A new basic profile is outlined and put into learning mode, which means that it logs any activity of the program you are executing, but does not yet restrict it.
2. Run the full range of the application's actions to let AppArmor get a specific picture of its activities.
3. Let AppArmor analyze the log files generated in *Step 2* by typing `S` in `aa-genprof`.
AppArmor scans the logs it recorded during the application's run and asks you to set the access rights for each event that was logged. Either set them for each file or use globbing.
4. Depending on the complexity of your application, it might be necessary to repeat *Step 2* and *Step 3*. Confine the application, exercise it under the confined conditions, and process any new log events. To properly confine the full range of an application's capabilities, you might be required to repeat this procedure often.
5. When you finish `aa-genprof`, your profile is set to enforce mode. The profile is applied and AppArmor restricts the application according to it.
If you started `aa-genprof` on an application that had an existing profile that was in complain mode, this profile remains in learning mode upon exit of this learning cycle. For more information about changing the mode of a profile, refer to *Section 37.7.3.2, "aa-complain—entering complain or learning mode"* and *Section 37.7.3.6, "aa-enforce—entering enforce mode"*.

Test your profile settings by performing every task you need with the application you confined. Normally, the confined program runs smoothly and you do not notice AppArmor activities. If you notice certain misbehavior with your application, check the system logs and see if AppArmor is too tightly confining your application. Depending on the log mechanism used on your system, there are several places to look for AppArmor log entries:

`/var/log/audit/audit.log`

The command `journalctl | grep -i apparmor`

The command `dmesg -T`

To adjust the profile, analyze the log messages relating to this application again as described in [Section 37.7.3.9, “aa-logprof—scanning the system log”](#). Determine the access rights or restrictions when prompted.



Tip: More information

For more information about profile building and modification, refer to [Chapter 34, Profile components and syntax](#), [Chapter 36, Building and managing profiles with YaST](#), and [Chapter 37, Building profiles from the command line](#).

32.5 Updating your profiles

Software and system configurations change over time. As a result, your profile setup for AppArmor might need certain fine-tuning from time to time. AppArmor checks your system log for policy violations or other AppArmor events and lets you adjust your profile set accordingly. Any application behavior that is outside of any profile definition can be addressed by **aa-logprof**. For more information, see [Section 37.7.3.9, “aa-logprof—scanning the system log”](#).

33 Immunizing programs

Effective hardening of a computer system requires minimizing the number of programs that mediate privilege, then securing the programs as much as possible. With AppArmor, you need to profile the programs that are exposed to attack in your environment, which drastically reduces the amount of work required to harden your computer. AppArmor profiles enforce policies to make sure that programs do what they are supposed to do, but nothing else.

AppArmor provides immunization technologies that protect applications from the inherent vulnerabilities they possess. After installing AppArmor, setting up AppArmor profiles, and rebooting the computer, your system becomes immunized because it begins to enforce the AppArmor security policies. Protecting programs with AppArmor is called *immunizing*.

Administrators should concern themselves with the applications that are vulnerable to attacks, and generate profiles for these. Hardening a system thus comes down to building and maintaining the AppArmor profile set and monitoring any policy violations or exceptions logged by AppArmor's reporting facility.

Users should not notice AppArmor. It runs “behind the scenes” and does not require any user interaction. Performance is not noticeably affected by AppArmor. If certain activity of the application is not covered by an AppArmor profile or if some activity of the application is prevented by AppArmor, the administrator needs to adjust the profile of this application.

AppArmor sets up a collection of default application profiles to protect standard Linux services. To protect other applications, use the AppArmor tools to create profiles for the applications that you want protected. This chapter introduces the philosophy of immunizing programs. Proceed to [Chapter 34, Profile components and syntax](#), [Chapter 36, Building and managing profiles with YaST](#), or [Chapter 37, Building profiles from the command line](#) if you are ready to build and manage AppArmor profiles.

AppArmor provides streamlined access control for network services by specifying which files each program is allowed to read, write and execute, and which type of network it is allowed to access. This ensures that each program does what it is supposed to do, and nothing else. AppArmor quarantines programs to protect the rest of the system from being damaged by a compromised process.

AppArmor is a host intrusion prevention or mandatory access control scheme. Previously, access control schemes were centered around users because they were built for large timeshare systems. Alternatively, modern network servers do not permit users to log in, but instead provide a variety

of network services for users (such as Web, mail, file and print servers). AppArmor controls the access given to network services and other programs to prevent weaknesses from being exploited.



Tip: Background information for AppArmor

To get a more in-depth overview of AppArmor and the overall concept behind it, refer to [Section 31.2, “Background information on AppArmor profiling”](#).

33.1 Introducing the AppArmor framework

This section provides a very basic understanding of what is happening “behind the scenes” (and under the hood of the YaST interface) when you run AppArmor.

An AppArmor profile is a plain text file containing path entries and access permissions. See [Section 34.1, “Breaking an AppArmor profile into its parts”](#) for a detailed reference profile. The directives contained in this text file are then enforced by the AppArmor routines to quarantine the process or program.

The following tools interact in the building and enforcement of AppArmor profiles and policies:

aa-status

aa-status reports various aspects of the current state of the running AppArmor confinement.

aa-unconfined

aa-unconfined detects any application running on your system that listens for network connections and is not protected by an AppArmor profile. Refer to [Section 37.7.3.12, “aa-unconfined—identifying unprotected processes”](#) for detailed information about this tool.

aa-autodep

aa-autodep creates a basic framework of a profile that needs to be fleshed out before it is put to use in production. The resulting profile is loaded and put into complain mode, reporting any behavior of the application that is not (yet) covered by AppArmor rules. Refer to [Section 37.7.3.1, “aa-autodep—creating approximate profiles”](#) for detailed information about this tool.

aa-genprof

aa-genprof generates a basic profile and asks you to refine this profile by executing the application and generating log events that need to be taken care of by AppArmor policies. You are guided through a series of questions to deal with the log events that have been triggered during the application's execution. After the profile has been generated, it is loaded and put into enforce mode. Refer to [Section 37.7.3.8, “aa-genprof—generating profiles”](#) for detailed information about this tool.

aa-logprof

aa-logprof interactively scans and reviews the log entries generated by an application that is confined by an AppArmor profile in both complain and enforced modes. It assists you in generating new entries in the profile concerned. Refer to [Section 37.7.3.9, “aa-logprof—scanning the system log”](#) for detailed information about this tool.

aa-easyprof

aa-easyprof provides an easy-to-use interface for AppArmor profile generation. **aa-easyprof** supports the use of templates and policy groups to quickly profile an application. While this tool can help with policy generation, its utility is dependent on the quality of the templates, policy groups and abstractions used. **aa-easyprof** may create a profile that is less restricted than creating the profile with **aa-genprof** and **aa-logprof**.

aa-complain

aa-complain toggles the mode of an AppArmor profile from enforce to complain. Violations to rules set in a profile are logged, but the profile is not enforced. Refer to [Section 37.7.3.2, “aa-complain—entering complain or learning mode”](#) for detailed information about this tool.

aa-enforce

aa-enforce toggles the mode of an AppArmor profile from complain to enforce. Violations to rules set in a profile are logged and not permitted—the profile is enforced. Refer to [Section 37.7.3.6, “aa-enforce—entering enforce mode”](#) for detailed information about this tool.

aa-disable

aa-disable disables the enforcement mode for one or more AppArmor profiles. This command unloads the profile from the kernel and prevent it from being loaded on AppArmor start-up. The **aa-enforce** and **aa-complain** utilities may be used to change this behavior.

aa-exec

aa-exec launches a program confined by the specified AppArmor profile and/or namespace. If both a profile and namespace are specified, the command is confined by the profile in the new policy namespace. If a namespace is specified, the profile name of the current confinement is used. If neither a profile or namespace is specified, the command runs using standard profile attachment—as if run without **aa-exec**.

aa-notify

aa-notify is a handy utility that displays AppArmor notifications in your desktop environment. You can also configure it to display a summary of notifications for the specified number of recent days. For more information, see [Section 37.7.3.13, “aa-notify”](#).

33.2 Determining programs to immunize

Now that you have familiarized yourself with AppArmor, start selecting the applications for which to build profiles. Programs that need profiling are those that mediate privilege. The following programs have access to resources that the person using the program does not have, so they grant the privilege to the user when used:

cron Jobs

Programs that are run periodically by **cron**. Such programs read input from a variety of sources and can run with special privileges, sometimes with as much as **root** privilege. For example, **cron** can run **/usr/sbin/logrotate** daily to rotate, compress or even mail system logs. For instructions for finding these types of programs, refer to [Section 33.3, “Immunizing cron jobs”](#).

Web applications

Programs that can be invoked through a Web browser, including CGI Perl scripts, PHP pages, and more complex Web applications. For instructions for finding these types of programs, refer to [Section 33.4.1, “Immunizing web applications”](#).

Network agents

Programs (servers and clients) that have open network ports. User clients, such as mail clients and Web browsers mediate privilege. These programs run with the privilege to write to the user's home directory and they process input from potentially hostile remote sources, such as hostile Web sites and e-mailed malicious code. For instructions for finding these types of programs, refer to [Section 33.4.2, “Immunizing network agents”](#).

Conversely, unprivileged programs do not need to be profiled. For example, a shell script might invoke the `cp` program to copy a file. Because `cp` does not by default have its own profile or subprofile, it inherits the profile of the parent shell script. Thus `cp` can copy any files that the parent shell script's profile can read and write.

33.3 Immunizing cron jobs

To find programs that are run by `cron`, inspect your local `cron` configuration. `cron` configuration is rather complex, so there are many files to inspect. Periodic `cron` jobs are run from these files:

```
/etc/crontab
/etc/cron.d/*
/etc/cron.daily/*
/etc/cron.hourly/*
/etc/cron.monthly/*
/etc/cron.weekly/*
```

The `crontab` command lists/edits the current user's crontab. To manipulate `root`'s `cron` jobs, first become `root`, and then edit the tasks with `crontab -e` or list them with `crontab -l`.

33.4 Immunizing network applications

An automated method for finding network server daemons that should be profiled is to use the `aa-unconfined` tool.

The `aa-unconfined` tool uses the command `netstat -nlp` to inspect open ports from inside your computer, detect the programs associated with those ports, and inspect the set of AppArmor profiles that you have loaded. `aa-unconfined` then reports these programs along with the AppArmor profile associated with each program, or reports “none” (if the program is not confined).



Note

If you create a new profile, you must restart the program that has been profiled to have it be effectively confined by AppArmor.

Below is a sample **aa-unconfined** output:

```
3702 ❶ /usr/sbin/sshd ❷ confined
    by '/usr/sbin/sshd ❸ (enforce)'
```

```
4040 /usr/sbin/smbd confined by '/usr/sbin/smbd (enforce)'
```

```
4373 /usr/lib/postfix/master confined by '/usr/lib/postfix/master (enforce)'
```

```
4505 /usr/sbin/httpd2-prefork confined by '/usr/sbin/httpd2-prefork (enforce)'
```

```
646 /usr/lib/wicked/bin/wickedd-dhcp4 not confined
```

```
647 /usr/lib/wicked/bin/wickedd-dhcp6 not confined
```

```
5592 /usr/bin/ssh not confined
```

```
7146 /usr/sbin/cupsd confined by '/usr/sbin/cupsd (complain)'
```

- ❶ The first portion is a number. This number is the process ID number (PID) of the listening program.
- ❷ The second portion is a string that represents the absolute path of the listening program
- ❸ The final portion indicates the profile confining the program, if any.



Note

aa-unconfined requires root privileges and should not be run from a shell that is confined by an AppArmor profile.

aa-unconfined does not distinguish between one network interface and another, so it reports all unconfined processes, even those that might be listening to an internal LAN interface.

Finding user network client applications is dependent on your user preferences. The **aa-unconfined** tool detects and reports network ports opened by client applications, but only those client applications that are running at the time the **aa-unconfined** analysis is performed. This is a problem because network services run all the time, while network client applications run when the user is interested in them.

Applying AppArmor profiles to user network client applications is also dependent on user preferences. Therefore, we leave the profiling of user network client applications as an exercise for the user.

To aggressively confine desktop applications, the **aa-unconfined** command supports a `--paranoid` option, which reports all processes running and the corresponding AppArmor profiles that might or might not be associated with each process. The user can then decide whether each of these programs needs an AppArmor profile.

If you have new or modified profiles, you can submit them to the apparmor@lists.ubuntu.com mailing list along with a use case for the application behavior that you exercised. The AppArmor team reviews and may submit the work into SUSE Linux Enterprise Server. We cannot guarantee that every profile is included, but we make a sincere effort to include as much as possible.

33.4.1 Immunizing web applications

To find Web applications, investigate your Web server configuration. The Apache Web server is highly configurable and Web applications can be stored in many directories, depending on your local configuration. SUSE Linux Enterprise Server, by default, stores Web applications in `/srv/www/cgi-bin/`. To the maximum extent possible, each Web application should have an AppArmor profile.

Once you find these programs, you can use the `aa-genprof` and `aa-logprof` tools to create or update their AppArmor profiles.

Because CGI programs are executed by the Apache Web server, the profile for Apache itself, `usr.sbin.httpd2-prefork` for Apache2 on SUSE Linux Enterprise Server, must be modified to add execute permissions to each of these programs. For example, adding the line `/srv/www/cgi-bin/my_hit_counter.pl rPx` grants Apache permission to execute the Perl script `my_hit_counter.pl` and requires that there be a dedicated profile for `my_hit_counter.pl`. If `my_hit_counter.pl` does not have a dedicated profile associated with it, the rule should say `/srv/www/cgi-bin/my_hit_counter.pl rix` to cause `my_hit_counter.pl` to inherit the `usr.sbin.httpd2-prefork` profile.

Some users might find it inconvenient to specify execute permission for every CGI script that Apache might invoke. Instead, the administrator can grant controlled access to collections of CGI scripts. For example, adding the line `/srv/www/cgi-bin/*.{pl,py,pyc} rix` allows Apache to execute all files in `/srv/www/cgi-bin/` ending in `.pl` (Perl scripts) and `.py` or `.pyc` (Python scripts). As above, the `ix` part of the rule causes Python scripts to inherit the Apache profile, which is appropriate if you do not want to write individual profiles for each CGI script.



Note

If you want the subprocess confinement module (`apache2-mod-apparmor`) functionality when Web applications handle Apache modules (`mod_perl` and `mod_php`), use the ChangeHat features when you add a profile in YaST or at the command line. To take advantage of the subprocess confinement, refer to [Section 38.2, “Managing ChangeHat-aware applications”](#).

Profiling Web applications that use `mod_perl` and `mod_php` requires slightly different handling. In this case, the “program” is a script interpreted directly by the module within the Apache process, so no exec happens. Instead, the AppArmor version of Apache calls `change_hat()` using a subprofile (a “hat”) corresponding to the name of the URI requested.



Note

The name presented for the script to execute might not be the URI, depending on how Apache has been configured for where to look for module scripts. If you have configured your Apache to place scripts in a different place, the different names appear in the log file when AppArmor complains about access violations. See [Chapter 40, Managing profiled applications](#).

For `mod_perl` and `mod_php` scripts, this is the name of the Perl script or the PHP page requested. For example, adding this subprofile allows the `localtime.php` page to execute and access to the local system time and locale files:

```
/usr/bin/httpd2-prefork {
# ...
^/cgi-bin/localtime.php {
    /etc/localtime          r,
    /srv/www/cgi-bin/localtime.php r,
    /usr/lib/locale/**      r,
}
}
```

If no subprofile has been defined, the AppArmor version of Apache applies the `DEFAULT_URI` hat. This subprofile is sufficient to display a Web page. The `DEFAULT_URI` hat that AppArmor provides by default is the following:

```
^DEFAULT_URI {
```

```

/usr/sbin/suexec2          mixr,
/var/log/apache2/**       rwl,
@{HOME}/public_html      r,
@{HOME}/public_html/**   r,
/srv/www/htdocs          r,
/srv/www/htdocs/**       r,
/srv/www/icons/*.{gif,jpg,png} r,
/srv/www/vhosts          r,
/srv/www/vhosts/**       r,
/usr/share/apache2/**     r,
/var/lib/php/sess_*      rwl
}

```

To use a single AppArmor profile for all Web pages and CGI scripts served by Apache, a good approach is to edit the `DEFAULT_URI` subprofile. For more information on confining Web applications with Apache, see [Chapter 38, Profiling your Web applications using ChangeHat](#).

33.4.2 Immunizing network agents

To find network server daemons and network clients (such as `fetchmail` or Firefox) that need to be profiled, you should inspect the open ports on your machine. Also, consider the programs that are answering on those ports, and provide profiles for as many of those programs as possible. If you provide profiles for all programs with open network ports, an attacker cannot get to the file system on your machine without passing through an AppArmor profile policy.

Scan your server for open network ports manually from outside the machine using a scanner (such as `nmap`), or from inside the machine using the `netstat --inet -n -p` command as `root`. Then, inspect the machine to determine which programs are answering on the discovered open ports.



Tip

Refer to the man page of the `netstat` command for a detailed reference of all possible options.

34 Profile components and syntax

Building AppArmor profiles to confine an application is straightforward and intuitive. AppArmor ships with several tools that assist in profile creation. It does not require you to do any programming or script handling. The only task that is required of the administrator is to determine a policy of strictest access and execute permissions for each application that needs to be hardened. Updates or modifications to the application profiles are only required if the software configuration or the desired range of activities changes. AppArmor offers intuitive tools to handle profile updates and modifications.

You are ready to build AppArmor profiles after you select the programs to profile. To do so, it is important to understand the components and syntax of profiles. AppArmor profiles contain several building blocks that help build simple and reusable profile code:

Include files

Include statements are used to pull in parts of other AppArmor profiles to simplify the structure of new profiles.

Abstractions

Abstractions are include statements grouped by common application tasks.

Program chunks

Program chunks are include statements that contain chunks of profiles that are specific to program suites.

Capability entries

Capability entries are profile entries for any of the POSIX.1e (<https://en.wikipedia.org/wiki/POSIX#POSIX.1>) Linux capabilities allowing a fine-grained control over what a confined process is allowed to do through system calls that require privileges.

Network access control entries

Network Access Control Entries mediate network access based on the address type and family.

Local variable definitions

Local variables define shortcuts for paths.

File access control entries

File Access Control Entries specify the set of files an application can access.

rlimit entries

rlimit entries set and control an application's resource limits.

For help determining the programs to profile, refer to [Section 33.2, “Determining programs to immunize”](#). To start building AppArmor profiles with YaST, proceed to [Chapter 36, Building and managing profiles with YaST](#). To build profiles using the AppArmor command line interface, proceed to [Chapter 37, Building profiles from the command line](#).

For more details about creating AppArmor profiles, see [man 5 apparmor](#).

34.1 Breaking an AppArmor profile into its parts

The easiest way of explaining what a profile consists of and how to create one is to show the details of a sample profile, in this case for a hypothetical application called [/usr/bin/foo](#):

```
#include <tunables/global> ❶

# a comment naming the application to confine
/usr/bin/foo ❷ { ❸
    #include <abstractions/base> ❹

    capability setgid ❺,
    network inet tcp ❻,

    link /etc/sysconfig/foo -> /etc/foo.conf, ❼
    /bin/mount          ux,
    /dev/{,u} ❸ random   r,
    /etc/ld.so.cache    r,
    /etc/foo/*          r,
    /lib/ld-*.so*       mr,
    /lib/lib*.so*       mr,
    /proc/[0-9]**       r,
    /usr/lib/**         mr,
    /tmp/               r, ❾
    /tmp/foo.pid        wr,
    /tmp/foo.*          lrw,
    /@{HOME} ❿/.foo_file rw,
    /@{HOME}/.foo_lock  kw,
    owner ❾ /shared/foo/** rw,
    /usr/bin/foobar     Cx, ❿
    /bin/**             Px -> bin_generic, ❿

    # a comment about foo's local (children) profile for /usr/bin/foobar.
```

```

profile /usr/bin/foobar 14 {
    /bin/bash          rmix,
    /bin/cat           rmix,
    /bin/more          rmix,
    /var/log/foobar*  rwl,
    /etc/foobar        r,
}

# foo's hat, bar.
^bar 15 {
    /lib/ld-*.so*      mr,
    /usr/bin/bar        px,
    /var/spool/*        rwl,
}
}

```

- ❶ This loads a file containing variable definitions.
- ❷ The normalized path to the program that is confined.
- ❸ The curly braces (`{}`) serve as a container for include statements, subprofiles, path entries, capability entries, and network entries.
- ❹ This directive pulls in components of AppArmor profiles to simplify profiles.
- ❺ Capability entry statements enable each of the 29 POSIX.1e draft capabilities.
- ❻ A directive determining the kind of network access allowed to the application. For details, refer to [Section 34.5, “Network access control”](#).
- ❼ A link pair rule specifying the source and the target of a link. See [Section 34.7.6, “Link pair”](#) for more information.
- ❽ The curly braces (`{}`) here allow for each of the listed possibilities, one of which is the empty string.
- ❾ A path entry specifying what areas of the file system the program can access. The first part of a path entry specifies the absolute path of a file (including regular expression globbing) and the second part indicates permissible access modes (for example `r` for read, `w` for write, and `x` for execute). A whitespace of any kind (spaces or tabs) can precede the path, but must separate the path and the mode specifier. Spaces between the access mode and the trailing comma are optional. Find a comprehensive overview of the available access modes in [Section 34.7, “File permission access modes”](#).
- ❿ This variable expands to a value that can be changed without changing the entire profile.
- ⓫ An owner conditional rule, granting read and write permission on files owned by the user. Refer to [Section 34.7.8, “Owner conditional rules”](#) for more information.

- 12 This entry defines a transition to the local profile `/usr/bin/foobar`. Find a comprehensive overview of the available execute modes in [Section 34.12, “Execute modes”](#).
- 13 A named profile transition to the profile `bin_generic` located in the global scope. See [Section 34.12.7, “Named profile transitions”](#) for details.
- 14 The local profile `/usr/bin/foobar` is defined in this section.
- 15 This section references a “hat” subprofile of the application. For more details on AppArmor's ChangeHat feature, refer to [Chapter 38, Profiling your Web applications using ChangeHat](#).

When a profile is created for a program, the program can access only the files, modes and POSIX capabilities specified in the profile. These restrictions are in addition to the Linux access controls.

Example: To gain the capability `CAP_CHOWN`, the program must have both access to `CAP_CHOWN` under conventional Linux access controls (typically, be a `root`-owned process) and have the capability `chown` in its profile. Similarly, to be able to write to the file `/foo/bar` the program must have both the correct user ID and mode bits set in the files attributes and have `/foo/bar w` in its profile.

Attempts to violate AppArmor rules are recorded in `/var/log/audit/audit.log` if the `audit` package is installed, or in `/var/log/messages`, or only in `journalctl` if no traditional syslog is installed. Often AppArmor rules prevent an attack from working because necessary files are not accessible and, in all cases, AppArmor confinement restricts the damage that the attacker can do to the set of files permitted by AppArmor.

34.2 Profile types

AppArmor knows four different types of profiles: standard profiles, unattached profiles, local profiles and hats. Standard and unattached profiles are stand-alone profiles, each stored in a file under `/etc/apparmor.d/`. Local profiles and hats are children profiles embedded inside of a parent profile used to provide tighter or alternate confinement for a subtask of an application.

34.2.1 Standard profiles

The default AppArmor profile is attached to a program by its name, so a profile name must match the path to the application it is to confine.

```
/usr/bin/foo {  
...  
}
```

This profile is automatically used whenever an unconfined process executes `/usr/bin/foo`.

34.2.2 Unattached profiles

Unattached profiles do not reside in the file system namespace and therefore are not automatically attached to an application. The name of an unattached profile is preceded by the keyword `profile`. You can freely choose a profile name, except for the following limitations: the name must not begin with a `:` or `.` character. If it contains a whitespace, it must be quoted. If the name begins with a `/`, the profile is considered to be a standard profile, so the following two profiles are identical:

```
profile /usr/bin/foo {  
...  
}  
/usr/bin/foo {  
...  
}
```

Unattached profiles are never used automatically, nor can they be transitioned to through a `Px` rule. They need to be attached to a program by either using a named profile transition (see [Section 34.12.7, “Named profile transitions”](#)) or with the `change_profile` rule (see [Section 34.2.5, “Change rules”](#)).

Unattached profiles are useful for specialized profiles for system utilities that generally should not be confined by a system-wide profile (for example, `/bin/bash`). They can also be used to set up roles or to confine a user.

34.2.3 Local profiles

Local profiles provide a convenient way to provide specialized confinement for utility programs launched by a confined application. They are specified like standard profiles, except that they are embedded in a parent profile and begin with the `profile` keyword:

```
/parent/profile {
  ...
  profile /local/profile {
    ...
  }
}
```

To transition to a local profile, either use a `cx` rule (see [Section 34.12.2, “Discrete local profile execute mode \(cx\)”](#)) or a named profile transition (see [Section 34.12.7, “Named profile transitions”](#)).

34.2.4 Hats

AppArmor "hats" are a local profiles with certain additional restrictions and an implicit rule allowing for `change_hat` to be used to transition to them. Refer to [Chapter 38, Profiling your Web applications using ChangeHat](#) for a detailed description.

34.2.5 Change rules

AppArmor provides `change_hat` and `change_profile` rules that control domain transitioning. `change_hat` are specified by defining hats in a profile, while `change_profile` rules refer to another profile and start with the keyword `change_profile`:

```
change_profile -> /usr/bin/foobar,
```

Both `change_hat` and `change_profile` provide for an application directed profile transition, without having to launch a separate application. `change_profile` provides a generic one way transition between any of the loaded profiles. `change_hat` provides for a returnable parent child transition where an application can switch from the parent profile to the hat profile and if it provides the correct secret key return to the parent profile at a later time.

`change_profile` is best used in situations where an application goes through a trusted setup phase and then can lower its privilege level. Any resources mapped or opened during the start-up phase may still be accessible after the profile change, but the new profile restricts the opening

of new resources, and limits certain resources opened before the switch. Specifically, memory resources are still available while capability and file resources (if they are not memory mapped) can be limited.

`change_hat` is best used in situations where an application runs a virtual machine or an interpreter that does not provide direct access to the applications resources (for example Apache's `mod_php`). Since `change_hat` stores the return secret key in the application's memory the phase of reduced privilege should not have direct access to memory. It is also important that file access is properly separated, since the hat can restrict accesses to a file handle but does not close it. If an application does buffering and provides access to the open files with buffering, the accesses to these files might not be seen by the kernel and hence not restricted by the new profile.



Warning: Safety of domain transitions

The `change_hat` and `change_profile` domain transitions are less secure than a domain transition done through an `exec` because they do not affect a process's memory mappings, nor do they close resources that have already been opened.

34.3 Include statements

Include statements are directives that pull in components of other AppArmor profiles to simplify profiles. Include files retrieve access permissions for programs. By using an include, you can give the program access to directory paths or files that are also required by other programs. Using includes can reduce the size of a profile.

Include statements normally begin with a hash (`#`) sign. This is confusing because the same hash sign is used for comments inside profile files. Because of this, `#include` is treated as an include only if there is no preceding `#` (`##include` is a comment) and there is no whitespace between `#` and `include` (`# include` is a comment).

You can also use `include` without the leading `#`.

```
include "/etc/apparmor.d/abstractions/foo"
```

is the same as using

```
#include "/etc/apparmor.d/abstractions/foo"
```



Note: No trailing ','

Because includes follow the C pre-processor syntax, they do not have a trailing ',' like most AppArmor rules.

By slight changes in syntax, you can modify the behavior of `include`. If you use `""` around the including path, you instruct the parser to do an absolute or relative path lookup.

```
include "/etc/apparmor.d/abstractions/foo" # absolute path
include "abstractions/foo" # relative path to the directory of current file
```

When using relative path includes, when the file is included, it is considered the new current file for its includes. For example, suppose you are in the `/etc/apparmor.d/bar` file, then

```
include "abstractions/foo"
```

includes the file `/etc/apparmor.d/abstractions/foo`. If then there is

```
include "example"
```

inside the `/etc/apparmor.d/abstractions/foo` file, it includes `/etc/apparmor.d/abstractions/example`.

The use of `<>` specifies to try the include path (specified by `-I`, defaults to the `/etc/apparmor.d` directory) in an ordered way. So assuming the include path is

```
-I /etc/apparmor.d/ -I /usr/share/apparmor/
```

then the include statement

```
include <abstractions/foo>
```

tries `/etc/apparmor.d/abstractions/foo`, and if that file does not exist, the next try is `/usr/share/apparmor/abstractions/foo`.



Tip

The default include path can be overridden manually by passing `-I` to the `apparmor_parser`, or by setting the include paths in `/etc/apparmor/parser.conf`:

```
Include /usr/share/apparmor/
Include /etc/apparmor.d/
```

Multiple entries are allowed, and they are taken in the same order as when they are when using `-I` or `--Include` from the `apparmor_parser` command line.

If an include ends with '/', this is considered a directory include, and all files within the directory are included.

To assist you in profiling your applications, AppArmor provides three classes of includes: abstractions, program chunks and tunables.

34.3.1 Abstractions

Abstractions are includes that are grouped by common application tasks. These tasks include access to authentication mechanisms, access to name service routines, common graphics requirements, and system accounting. Files listed in these abstractions are specific to the named task. Programs that require one of these files also requires other files listed in the abstraction file (depending on the local configuration and the specific requirements of the program). Find abstractions in [/etc/apparmor.d/abstractions](#).

34.3.2 Program chunks

The program-chunks directory ([/etc/apparmor.d/program-chunks](#)) contains certain chunks of profiles that are specific to program suites and not generally useful outside of the suite, thus are never suggested for use in profiles by the profile wizards (**aa-logprof** and **aa-genprof**). Currently, program chunks are only available for the postfix program suite.

34.3.3 Tunables

The tunables directory ([/etc/apparmor.d/tunables](#)) contains global variable definitions. When used in a profile, these variables expand to a value that can be changed without changing the entire profile. Add all the tunables definitions that should be available to every profile to [/etc/apparmor.d/tunables/global](#).

34.4 Capability entries (POSIX.1e)

Capability rules are simply the word `capability` followed by the name of the POSIX.1e capability as defined in the [capabilities\(7\)](#) man page. You can list multiple capabilities in a single rule, or grant all implemented capabilities with the bare keyword `capability`.

```
capability dac_override sys_admin, # multiple capabilities
capability, # grant all capabilities
```

34.5 Network access control

AppArmor allows mediation of network access based on the address type and family. The following illustrates the network access rule syntax:

```
network [[<domain>①][<type>②][<protocol>③]]
```

- ① Supported domains: inet, ax25, ipx, appletalk, netrom, bridge, x25, inet6, rose, netbeui, security, key, packet, ash, econet, atmsvc, sna, pppox, wan-pipe, bluetooth, unix, atmpvc, netlink, llc, can, tipc, iucv, rxrpc, isdn, phonet, ieee802154, caif, alg, nfc, vsock
- ② Supported types: stream, dgram, seqpacket, rdm, raw, packet
- ③ Supported protocols: tcp, udp, icmp

The AppArmor tools support only family and type specification. The AppArmor module emits only `network DOMAIN TYPE` in “ACCESS DENIED” messages. And only these are output by the profile generation tools, both YaST and command line.

The following examples illustrate possible network-related rules to be used in AppArmor profiles. The syntax of the last two are not currently supported by the AppArmor tools.

```
network①,
network inet②,
network inet6③,
network inet stream④,
network inet tcp⑤,
network tcp⑥,
```

- ① Allow all networking. No restrictions applied with regard to domain, type, or protocol.
- ② Allow general use of IPv4 networking.
- ③ Allow general use of IPv6 networking.
- ④ Allow the use of IPv4 TCP networking.
- ⑤ Allow the use of IPv4 TCP networking, paraphrasing the rule above.
- ⑥ Allow the use of both IPv4 and IPv6 TCP networking.

34.6 Profile names, flags, paths, and globbing

A profile is attached to a program by specifying a full path to the program's executable. For example, a standard profile (see [Section 34.2.1, "Standard profiles"](#)), the profile is defined by

```
/usr/bin/foo { ... }
```

The following sections describe several useful techniques that can be applied when naming a profile or putting a profile in the context of other existing ones, or specifying file paths.

AppArmor explicitly distinguishes directory path names from path names. Use a trailing `/` for any directory path that needs to be explicitly distinguished:

```
/some/random/example/* r
```

Allow read access to files in the /some/random/example directory.

```
/some/random/example/ r
```

Allow read access to the directory only.

```
/some/**/ r
```

Give read access to any directories below /some (but not /some/ itself).

```
/some/random/example/** r
```

Give read access to files and directories under /some/random/example (but not /some/random/example/ itself).

```
/some/random/example/**[^/] r
```

Give read access to files under /some/random/example. Explicitly exclude directories ([^/]).

Globbing (or regular expression matching) is when you modify the directory path using wild cards to include a group of files or subdirectories. File resources can be specified with a globbing syntax similar to that used by popular shells, such as `csh`, `Bash` and `zsh`.

<u>*</u>	Substitutes for any number of any characters, except <u>/</u> . Example: An arbitrary number of path elements.
<u>**</u>	Substitutes for any number of characters, including <u>/</u> .

	Example: An arbitrary number of path elements, including entire directories.
<u>?</u>	Substitutes for any single character, except <u>/</u> .
<u>[abc]</u>	Substitutes for the single character <u>a</u> , <u>b</u> , or <u>c</u> . Example: a rule that matches <u>/home[01]/*/.plan</u> allows a program to access <u>.plan</u> files for users in both <u>/home0</u> and <u>/home1</u> .
<u>[a-c]</u>	Substitutes for the single character <u>a</u> , <u>b</u> , or <u>c</u> .
<u>{ab,cd}</u>	Expands to one rule to match <u>ab</u> and one rule to match <u>cd</u> . Example: a rule that matches <u>{usr,www}/pages/**</u> grants access to Web pages in both <u>/usr/pages</u> and <u>/www/pages</u> .
<u>[^a]</u>	Substitutes for any character except <u>a</u> .

34.6.1 Profile flags

Profile flags control the behavior of the related profile. You can add profile flags to the profile definition by editing it manually, see the following syntax:

```
/path/to/profiled/binary flags=(list_of_flags) {
  [...]
}
```

You can use multiple flags separated by a comma ',' or space ' '. There are three basic types of profile flags: mode, relative, and attach flags.

Mode flag is complain (illegal accesses are allowed and logged). If it is omitted, the profile is in enforce mode (enforces the policy).



Tip

A more flexible way of setting the whole profile into complain mode is to create a symbolic link from the profile file inside the `/etc/apparmor.d/force-complain/` directory.

```
ln -s /etc/apparmor.d/bin.ping /etc/apparmor.d/force-complain/bin.ping
```

Relative flags are `chroot_relative` (states that the profile is relative to the chroot instead of namespace) or `namespace_relative` (the default, with the path being relative to outside the chroot). They are mutually exclusive.

Attach flags consist of two pairs of mutually exclusive flags: `attach_disconnected` or `no_attach_disconnected` (determine if path names resolved to be outside of the namespace are attached to the root, which means they have the '/' character at the beginning), and `chroot_attach` or `chroot_no_attach` (control path name generation when in a chroot environment while a file is accessed that is external to the chroot but within the namespace).

34.6.2 Using variables in profiles

AppArmor allows to use variables holding paths in profiles. Use global variables to make your profiles portable and local variables to create shortcuts for paths.

A typical example of when global variables come in handy are network scenarios in which user home directories are mounted in different locations. Instead of rewriting paths to home directories in all affected profiles, you only need to change the value of a variable. Global variables are defined under `/etc/apparmor.d/tunables` and need to be made available via an include statement. Find the variable definitions for this use case (`@{HOME}` and `@{HOMEDIRS}`) in the `/etc/apparmor.d/tunables/home` file.

Local variables are defined at the head of a profile. This is useful to provide the base of for a chrooted path, for example:

```
@{CHROOT_BASE}=/tmp/foo
/sbin/rsyslogd {
...
# chrooted applications
@{CHROOT_BASE}/var/lib/*/dev/log w,
@{CHROOT_BASE}/var/log/** w,
...
}
```

In the following example, while `@{HOMEDIRS}` lists where all the user home directories are stored, `@{HOME}` is a space-separated list of home directories. Later on, `@{HOMEDIRS}` is expanded by two new specific places where user home directories are stored.

```
@{HOMEDIRS}=/home/  
@{HOME}=@{HOMEDIRS}/* /root/  
[...]  
@{HOMEDIRS}+=/srv/nfs/home/ /mnt/home/
```



Note

With the current AppArmor tools, variables can only be used when manually editing and maintaining a profile.

34.6.3 Pattern matching

Profile names can contain globbing expressions allowing the profile to match against multiple binaries.

The following example is valid for systems where the `foo` binary resides either in `/usr/bin` or `/bin`.

```
{usr,}bin/foo { ... }
```

In the following example, when matching against the executable `/bin/foo`, the `/bin/foo` profile is an exact match so it is chosen. For the executable `/bin/fat`, the profile `/bin/foo` does not match, and because the `/bin/f*` profile is more specific (less general) than `/bin/**`, the `/bin/f*` profile is chosen.

```
/bin/foo { ... }  
  
/bin/f* { ... }  
  
/bin/** { ... }
```

For more information on profile name globbing examples, see the man page of AppArmor, [man 5 apparmor.d](#), section [Globbing](#).

34.6.4 Namespaces

Namespaces are used to provide different profiles sets. Say one for the system, another for a chroot environment or container. Namespaces are hierarchical—a namespace can see its children but a child cannot see its parent. Namespace names start with a colon `:` followed by an alphanumeric string, a trailing colon `:` and an optional double slash `//`, such as

```
:childNameSpace://
```

Profiles loaded to a child namespace are prefixed with their namespace name (viewed from a parent's perspective):

```
:childNameSpace://apache
```

Namespaces can be entered via the `change_profile` API, or named profile transitions:

```
/path/to/executable px -> :childNameSpace://apache
```

34.6.5 Profile naming and attachment specification

Profiles can have a name, and an attachment specification. This allows for profiles with a logical name that can be more meaningful to users/administrators than a profile name that contains pattern matching (see [Section 34.6.3, "Pattern matching"](#)). For example, the default profile

```
/** { ... }
```

can be named

```
profile default /** { ... }
```

Also, a profile with pattern matching can be named. For example:

```
/usr/lib64/firefox*/firefox-*bin { ... }
```

can be named

```
profile firefox /usr/lib64/firefox*/firefox-*bin { ... }
```

34.6.6 Alias rules

Alias rules provide an alternative way to manipulate profile path mappings to site specific layouts. They are an alternative form of path rewriting to using variables, and are done post variable resolution. The alias rule says to treat rules that have the same source prefix as if the rules are at target prefix.

```
alias /home/ -> /usr/home/
```

All the rules that have a prefix match to `/home/` provide access to `/usr/home/`. For example:

```
/home/username/** r,
```

allows as well access to

```
/usr/home/username/** r,
```

Aliases provide a quick way of remapping rules without the need to rewrite them. They keep the source path still accessible—in our example, the alias rule keeps the paths under `/home/` still accessible.

With the `alias` rule, you can point to multiple targets at the same time.

```
alias /home/ -> /usr/home/  
alias /home/ -> /mnt/home/
```



Note

With the current AppArmor tools, alias rules can only be used when manually editing and maintaining a profile.



Tip

Insert global alias definitions in the file `/etc/apparmor.d/tunables/alias`.

34.7 File permission access modes

File permission access modes consist of combinations of the following modes:

<u>r</u>	Read mode
<u>w</u>	Write mode (mutually exclusive to <u>a</u>)

<u>a</u>	Append mode (mutually exclusive to <u>w</u>)
<u>k</u>	File locking mode
<u>l</u>	Link mode
<u>link FILE -> TARGET</u>	Link pair rule (cannot be combined with other access modes)

34.7.1 Read mode (r)

Allows the program to have read access to the resource. Read access is required for shell scripts and other interpreted content and determines if an executing process can core dump.

34.7.2 Write mode (w)

Allows the program to have write access to the resource. Files must have this permission if they are to be unlinked (removed).

34.7.3 Append mode (a)

Allows a program to write to the end of a file. In contrast to the w mode, the append mode does not include the ability to overwrite data, to rename, or to remove a file. The append permission is typically used with applications who need to be able to write to log files, but which should not be able to manipulate any existing data in the log files. As the append permission is a subset of the permissions associated with the write mode, the w and a permission flags cannot be used together and are mutually exclusive.

34.7.4 File locking mode (k)

The application can take file locks. Former versions of AppArmor allowed files to be locked if an application had access to them. By using a separate file locking mode, AppArmor makes sure locking is restricted only to those files which need file locking and tightens security as locking can be used in several denial-of-service attack scenarios.

34.7.5 Link mode (l)

The link mode mediates access to hard links. When a link is created, the target file must have the same access permissions as the link created (but the destination does not need link access).

34.7.6 Link pair

The link mode grants permission to link to arbitrary files, provided the link has a subset of the permissions granted by the target (subset permission test).

```
/srv/www/htdocs/index.html rl,
```

By specifying origin and destination, the link pair rule provides greater control over how hard links are created. Link pair rules by default do not enforce the link subset permission test that the standard rules link permission requires.

```
link /srv/www/htdocs/index.html -> /var/www/index.html
```

To force the rule to require the test, the subset keyword is used. The following rules are equivalent:

```
/var/www/index.html l,  
link subset /var/www/index.html -> /**,
```



Note

Currently link pair rules are not supported by YaST and the command-line tools. Manually edit your profiles to use them. Updating such profiles using the tools is safe, because the link pair entries are not touched.

34.7.7 Optional allow and file rules

The allow prefix is optional, and it is idiomatically implied if not specified and the deny (see [Section 34.7.9, “Deny rules”](#)) keyword is not used.

```
allow file /example r,  
allow /example r,  
allow network,
```

You can also use the optional file keyword. If you omit it and there are no other rule types that start with a keyword, such as network or mount, it is automatically implied.

```
file /example/rule r,
```

is equivalent to

```
/example/rule r,
```

The following rule grants access to all files:

```
file,
```

which is equal to

```
/** rwmlk,
```

File rules can use leading or trailing permissions. The permissions should not be specified as a trailing permission, but rather used at the start of the rule. This is important in that it makes file rules behave like any other rule types.

```
/path rw,          # old style
rw /path,          # leading permission
file rw /path,     # with explicit 'file' keyword
allow file rw /path, # optional 'allow' keyword added
```

34.7.8 Owner conditional rules

The file rules can be extended so that they can be conditional upon the user being the owner of the file (the fsuid needs to match the file's uid). For this purpose the `owner` keyword is put in front of the rule. Owner conditional rules accumulate like regular file rules do.

```
owner /home/*/** rw
```

When using file ownership conditions with link rules the ownership test is done against the target file so the user must own the file to be able to link to it.



Note: Precedence of regular file rules

Owner conditional rules are considered a subset of regular file rules. If a regular file rule overlaps with an owner conditional file rule, the rules are merged. Consider the following example.

```
/foo r,
owner /foo rw, # or w,
```

The rules are merged—it results in r for everybody, and w for the owner only.



Tip

To address everybody *but* the owner of the file, use the keyword other.

```
owner /foo rw,  
other /foo r,
```

34.7.9 Deny rules

Deny rules can be used to annotate or quiet known rejects. The profile generating tools do not ask about a known reject treated with a deny rule. Such a reject does not show up in the audit logs when denied, keeping the log files lean. If this is not desired, put the keyword audit in front of the deny entry.

It is also possible to use deny rules in combination with allow rules. This allows you to specify a broad allow rule, and then subtract a few known files that should not be allowed. Deny rules can also be combined with owner rules, to deny files owned by the user. The following example allows read/write access to everything in a users directory except write access to the .ssh/ files:

```
deny /home/*/ .ssh/** w,  
owner /home/*/** rw,
```

The extensive use of deny rules is generally not encouraged, because it makes it much harder to understand what a profile does. However a judicious use of deny rules can simplify profiles. Therefore the tools only generate profiles denying specific files and do not use globbing in deny rules. Manually edit your profiles to add deny rules using globbing. Updating such profiles using the tools is safe, because the deny entries are not touched.

34.8 Mount rules

AppArmor can limit mount and unmount operations, including file system types and mount flags. The rule syntax is based on the mount command syntax and starts with one of the keywords mount, remount, or umount. Conditions are optional and unspecified conditionals are assumed to match all entries. For example, not specifying a file system means that all file systems are matched.

Conditionals can be specified by specifying conditionals with `options=` or `options in`. `options=` specifies conditionals that have to be met exactly. The rule

```
mount options=ro /dev/foo -E /mnt/,
```

matches

```
# mount -o ro /dev/foo /mnt
```

but does not match

```
# mount -o ro,atime /dev/foo /mnt
# mount -o rw /dev/foo /mnt
```

`options in` requires that at least one of the listed mount options is used. The rule

```
mount options in (ro,atime) /dev/foo -> /mnt/,
```

matches

```
# mount -o ro /dev/foo /mnt
# mount -o ro,atime /dev/foo /mnt
# mount -o atime /dev/foo /mnt
```

but does not match

```
# mount -o ro,sync /dev/foo /mnt
# mount -o ro,atime,sync /dev/foo /mnt
# mount -o rw /dev/foo /mnt
# mount -o rw,noatime /dev/foo /mnt
# mount /dev/foo /mnt
```

With multiple conditionals, the rule grants permission for each set of options. The rule

```
mount options=ro options=atime
```

matches

```
# mount -o ro /dev/foo /mnt
# mount -o atime /dev/foo /mnt
```

but does not match

```
# mount -o ro,atime /dev/foo /mnt
```

Separate mount rules are distinct and the options do not accumulate. The rules

```
mount options=ro,  
mount options=atime,
```

are not equivalent to

```
mount options=(ro,atime),  
mount options in (ro,atime),
```

The following rule allows mounting `/dev/foo` on `/mnt/` read only and using inode access times or allows mounting `/dev/foo` on `/mnt/` with some combination of 'nodev' and 'user'.

```
mount options=(ro, atime) options in (nodev, user) /dev/foo -> /mnt/,
```

allows

```
# mount -o ro,atime /dev/foo /mnt  
# mount -o nodev /dev/foo /mnt  
# mount -o user /dev/foo /mnt  
# mount -o nodev,user /dev/foo /mnt
```

34.9 Pivot root rules

AppArmor can limit changing the root file system. The syntax is

```
pivot_root [oldroot=OLD_ROOT] NEW_ROOT
```

The paths specified in 'pivot_root' rules must end with '/' since they are directories.

```
# Allow any pivot  
pivot_root,  
  
# Allow pivoting to any new root directory and putting the old root  
# directory at /mnt/root/old/  
pivot_root oldroot=/mnt/root/old/,  
  
# Allow pivoting the root directory to /mnt/root/  
pivot_root /mnt/root/,  
  
# Allow pivoting to /mnt/root/ and putting the old root directory at  
# /mnt/root/old/  
pivot_root oldroot=/mnt/root/old/ /mnt/root/,
```

```
# Allow pivoting to /mnt/root/, putting the old root directory at
# /mnt/root/old/ and transition to the /mnt/root/sbin/init profile
pivot_root oldroot=/mnt/root/old/ /mnt/root/ -> /mnt/root/sbin/init,
```

34.10 PTrace rules

AppArmor supports limiting ptrace system calls. ptrace rules are accumulated so that the granted ptrace permissions are the union of all the listed ptrace rule permissions. If a rule does not specify an access list, permissions are implicitly granted.

The `trace` and `tracedby` permissions control `ptrace(2)`; `read` and `readby` control `proc(5)` file system access, `kcmp(2)`, `futexes (get_robust_list(2))` and `perf` trace events.

For a ptrace operation to be allowed, the tracing and traced processes need the correct permissions. This means that the tracing process needs the `trace` permission and the traced process needs the `tracedby` permission.

Example AppArmor PTrace rules:

```
# Allow all PTrace access
ptrace,

# Explicitly allow all PTrace access,
ptrace (read, readby, trace, tracedby),

# Explicitly deny use of ptrace(2)
deny ptrace (trace),

# Allow unconfined processes (eg, a debugger) to ptrace us
ptrace (readby, tracedby) peer=unconfined,

# Allow ptrace of a process running under the /usr/bin/foo profile
ptrace (trace) peer=/usr/bin/foo,
```

34.11 Signal rules

AppArmor supports limiting inter-process signals. AppArmor signal rules are accumulated so that the granted signal permissions are the union of all the listed signal rule permissions. AppArmor signal permissions are implied when a rule does not explicitly state an access list.

The sending and receiving process must both have the correct permissions.

Example signal rules:

```
# Allow all signal access
signal,

# Explicitly deny sending the HUP and INT signals
deny signal (send) set=(hup, int),

# Allow unconfined processes to send us signals
signal (receive) peer=unconfined,

# Allow sending of signals to a process running under the /usr/bin/foo
# profile
signal (send) peer=/usr/bin/foo,

# Allow checking for PID existence
signal (receive, send) set=("exists"),

# Allow us to signal ourselves using the built-in @{profile_name} variable
signal peer=@{profile_name},

# Allow two real-time signals
signal set=(rtmin+0 rtmin+32),
```

34.12 Execute modes

Execute modes, also named profile transitions, consist of the following modes:

<u>Px</u>	Discrete profile execute mode
<u>Cx</u>	Discrete local profile execute mode
<u>Ux</u>	Unconfined execute mode
<u>ix</u>	Inherit execute mode
<u>m</u>	Allow <u>PROT_EXEC</u> with <u>mmap(2)</u> calls

34.12.1 Discrete profile execute mode (px)

This mode requires that a discrete security profile is defined for a resource executed at an AppArmor domain transition. If there is no profile defined, the access is denied.

Incompatible with Ux, ux, px, and ix.

34.12.2 Discrete local profile execute mode (cx)

As Px, but instead of searching the global profile set, Cx only searches the local profiles of the current profile. This profile transition provides a way for an application to have alternate profiles for helper applications.



Note: Limitations of the discrete local profile execute mode (cx)

Currently, Cx transitions are limited to top level profiles and cannot be used in hats and children profiles. This restriction will be removed in the future.

Incompatible with Ux, ux, Px, px, cx, and ix.

34.12.3 Unconfined execute mode (ux)

Allows the program to execute the resource without any AppArmor profile applied to the executed resource. This mode is useful when a confined program needs to be able to perform a privileged operation, such as rebooting the machine. By placing the privileged section in another executable and granting unconfined execution rights, it is possible to bypass the mandatory constraints imposed on all confined processes. Allowing a root process to go unconfined means it can change AppArmor policy itself. For more information about what is constrained, see the [apparmor\(7\)](#) man page.

This mode is incompatible with ux, px, Px, and ix.

34.12.4 Unsafe exec modes

Use the lowercase versions of exec modes—`px`, `cx`, `ux`—only in special cases. They do not scrub the environment of variables such as `LD_PRELOAD`. As a result, the calling domain may have an undue amount of influence over the called resource. Use these modes only if the child absolutely *must* be run unconfined and `LD_PRELOAD` must be used. Any profile using such modes provides negligible security. Use at your own risk.

34.12.5 Inherit execute mode (ix)

`ix` prevents the normal AppArmor domain transition on `execve(2)` when the profiled program executes the named program. Instead, the executed resource inherits the current profile.

This mode is useful when a confined program needs to call another confined program without gaining the permissions of the target's profile or losing the permissions of the current profile. There is no version to scrub the environment because `ix` executions do not change privileges. Incompatible with `cx`, `ux`, and `px`. Implies `m`.

34.12.6 Allow executable mapping (m)

This mode allows a file to be mapped into memory using `mmap(2)`'s `PROT_EXEC` flag. This flag marks the pages executable. It is used on certain architectures to provide non executable data pages, which can complicate exploit attempts. AppArmor uses this mode to limit which files a well-behaved program (or all programs on architectures that enforce non executable memory access controls) may use as libraries, to limit the effect of invalid `-L` flags given to `ld(1)` and `LD_PRELOAD`, `LD_LIBRARY_PATH`, given to `ld.so(8)`.

34.12.7 Named profile transitions

By default, the `px` and `cx` (and their clean exec variants, too) transition to a profile whose name matches the executable name. With named profile transitions, you can specify a profile to be transitioned to. This is useful if multiple binaries need to share a single profile, or if they need to use a different profile than their name would specify. Named profile transitions can be used with `cx`, `Cx`, `px` and `Px`. Currently there is a limit of twelve named profile transitions per profile.

Named profile transitions use `->` to indicate the name of the profile that needs to be transitioned to:

```
/usr/bin/foo
{
  /bin/** px -> shared_profile,
  ...
  /usr/*bash cx -> local_profile,
  ...
  profile local_profile
  {
    ...
  }
}
```



Note: Difference between normal and named transitions

When used with globbing, normal transitions provide a “one to many” relationship—`/bin/** px` transitions to `/bin/ping`, `/bin/cat`, etc, depending on the program being run.

Named transitions provide a “many to one” relationship—all programs that match the rule regardless of their name transition to the specified profile.

Named profile transitions show up in the log as having the mode `Nx`. The name of the profile to be changed to is listed in the `name2` field.

34.12.8 Fallback modes for profile transitions

The `px` and `cx` transitions specify a hard dependency—if the specified profile does not exist, the exec fails. With the inheritance fallback, the execution succeeds but inherits the current profile. To specify inheritance fallback, `ix` is combined with `cx`, `Cx`, `px` and `Px` into the modes `cix`, `Cix`, `pix` and `Pix`.

```
/path Cix -> profile_name,
```

or

```
Cix /path -> profile_name,
```

where `-> profile_name` is optional.

The same applies if you add the unconfined ux mode, where the resulting modes are cux, CUx, pux and PUx. These modes allow falling back to “unconfined” when the specified profile is not found.

```
/path PUx -> profile_name,
```

or

```
PUx /path -> profile_name,
```

where -> profile_name is optional.

The fallback modes can be used with named profile transitions, too.

34.12.9 Variable settings in execution modes

When choosing one of the Px, Cx or Ux execution modes, take into account that the following environment variables are removed from the environment before the child process inherits it. As a consequence, applications or processes relying on any of these variables do not work anymore if the profile applied to them carries Px, Cx or Ux flags:

- GCONV_PATH
- GETCONF_DIR
- HOSTALIASES
- LD_AUDIT
- LD_DEBUG
- LD_DEBUG_OUTPUT
- LD_DYNAMIC_WEAK
- LD_LIBRARY_PATH
- LD_ORIGIN_PATH
- LD_PRELOAD
- LD_PROFILE
- LD_SHOW_AUXV
- LD_USE_LOAD_BIAS

- LOCALDOMAIN
- LOCPATH
- MALLOC_TRACE
- NLSPATH
- RESOLV_HOST_CONF
- RES_OPTIONS
- TMPDIR
- TZDIR

34.12.10 safe and unsafe keywords

You can use the safe and unsafe keywords for rules instead of using the case modifier of execution modes. For example

```
/example_rule Px,
```

is the same as any of the following

```
safe /example_rule px,
safe /example_rule Px,
safe px /example_rule,
safe Px /example_rule,
```

and the rule

```
/example_rule px,
```

is the same as any of

```
unsafe /example_rule px,
unsafe /example_rule Px,
unsafe px /example_rule,
unsafe Px /example_rule,
```

The safe/unsafe keywords are mutually exclusive and can be used in a file rule after the owner keyword, so the order of rule keywords is

```
[audit] [deny] [owner] [safe|unsafe] file_rule
```

34.13 Resource limit control

AppArmor can set and control an application's resource limits (rlimits, also known as ulimits). By default, AppArmor does not control an application's rlimits, and it controls those limits specified in the confining profile. For more information about resource limits, refer to the [setrlimit\(2\)](#), [ulimit\(1\)](#), or [ulimit\(3\)](#) man pages.

AppArmor leverages the system's rlimits and as such does not provide an additional auditing that would normally occur. It also cannot raise rlimits set by the system, AppArmor rlimits can only reduce an application's current resource limits.

The values are inherited by the children of a process and remain even if a new profile is transitioned to or the application becomes unconfined. So when an application transitions to a new profile, that profile can further reduce the application's rlimits.

AppArmor's rlimit rules provide mediation of setting an application's hard limits, should it try to raise them. The application cannot raise its hard limits any further than specified in the profile. The mediation of raising hard limits is not inherited as the set value is, so that when the application transitions to a new profile it is free to raise its limits as specified in the profile.

AppArmor's rlimit control does not affect an application's soft limits beyond ensuring that they are less than or equal to the application's hard limits.

AppArmor's hard limit rules have the general form of:

```
set rlimit RESOURCE <= value,
```

where [RESOURCE](#) and [VALUE](#) are to be replaced with the following values:

[cpu](#)

CPU time limit in seconds.

[fsize](#), [data](#), [stack](#), [core](#), [rss](#), [as](#), [memlock](#), [msgqueue](#)

a number in bytes, or a number with a suffix where the suffix can be K/KB (kilobytes), M/MB (megabytes), G/GB (gigabytes), for example

```
rlimit data <= 100M,
```

[fsize](#), [nofile](#), [locks](#), [sigpending](#), [nproc](#), [rtprio](#)

a number greater or equal to 0

[nice](#)

a value between -20 and 19



Note

The `nproc rlimit` is handled different than all the other `rlimits`. Instead of indicating the standard process `rlimit`, it controls the maximum number of processes that can be running under the profile at any time. When the limit is exceeded, the creation of new processes under the profile fails until the number of currently running processes is reduced.



Note

Currently the tools cannot be used to add `rlimit` rules to profiles. The only way to add `rlimit` controls to a profile is to manually edit the profile with a text editor. The tools still work with profiles containing `rlimit` rules and will not remove them, so it is safe to use the tools to update profiles containing them.

34.14 Auditing rules

AppArmor provides the ability to audit given rules so that when they are matched, an audit message appears in the audit log. To enable audit messages for a given rule, the `audit` keyword is put in front of the rule:

```
audit /etc/foo/*      rw,
```

If it is desirable to audit only a given permission, the rule can be split into two rules. The following example results in audit messages when files are opened for writing, but not when they are opened for reading:

```
audit /etc/foo/* w,  
/etc/foo/*      r,
```



Note

Audit messages are not generated for every read or write of a file but only when a file is opened for reading or writing.

Audit control can be combined with `owner/other` conditional file rules to provide auditing when users access files they own/do not own:

```
audit owner /home/*/.ssh/**      rw,
```

```
audit other /home/*/.ssh/** r,
```

35 AppArmor profile repositories

AppArmor ships with a set of profiles enabled by default. These are created by the AppArmor developers, and are stored in `/etc/apparmor.d`. In addition to these profiles, SUSE Linux Enterprise Server ships profiles for individual applications together with the relevant application. These profiles are not enabled by default, and reside under another directory than the standard AppArmor profiles, `/usr/share/apparmor/extra-profiles`.

The AppArmor tools (YaST, `aa-genprof` and `aa-logprof`) support the use of a local repository. Whenever you start to create a new profile from scratch, and there already is an inactive profile in your local repository, you are asked whether you want to use the existing inactive one from `/usr/share/apparmor/extra-profiles` and whether you want to base your efforts on it. If you decide to use this profile, it gets copied over to the directory of profiles enabled by default (`/etc/apparmor.d`) and loaded whenever AppArmor is started. Any further adjustments will be done to the active profile under `/etc/apparmor.d`.

36 Building and managing profiles with YaST

YaST provides a basic way to build profiles and manage AppArmor® profiles. It provides two interfaces: a graphical one and a text-based one. The text-based interface consumes less resources and bandwidth, making it a better choice for remote administration, or for times when a local graphical environment is inconvenient. Although the interfaces have differing appearances, they offer the same functionality in similar ways. Another alternative is to use AppArmor commands, which can control AppArmor from a terminal window or through remote connections. The command line tools are described in [Chapter 37, Building profiles from the command line](#).

Start YaST from the main menu and enter your `root` password when prompted for it. Alternatively, start YaST by opening a terminal window, logging in as `root`, and entering `yast2` for the graphical mode or `yast` for the text-based mode.

In the *Security and Users* section, there is an *AppArmor Configuration* icon. Click it to launch the AppArmor YaST module.

36.1 Manually adding a profile

AppArmor enables you to create an AppArmor profile by manually adding entries into the profile. Select the application for which to create a profile, then add entries.

1. Start YaST, select *AppArmor Configuration*, and click *Manually Add Profile* in the main window.
2. Browse your system to find the application for which to create a profile.
3. When you find the application, select it and click *Open*. A basic, empty profile appears in the *AppArmor Profile Dialog* window.
4. In *AppArmor Profile Dialog*, add, edit, or delete AppArmor profile entries by clicking the corresponding buttons and referring to [Section 36.2.1, “Adding an entry”](#), [Section 36.2.2, “Editing an entry”](#), or [Section 36.2.3, “Deleting an entry”](#).
5. When finished, click *Done*.

36.2 Editing profiles



Tip

YaST offers basic manipulation for AppArmor profiles, such as creating or editing. However, the most straightforward way to edit an AppArmor profile is to use a text editor such as vi:

```
> sudo vi /etc/apparmor.d/usr.sbin.httpd2-prefork
```



Tip

The vi editor also includes syntax (error) highlighting and syntax error highlighting, which visually warns you when the syntax of the edited AppArmor profile is wrong.

AppArmor enables you to edit AppArmor profiles manually by adding, editing or deleting entries. To edit a profile, proceed as follows:

1. Start YaST, select *AppArmor Configuration*, and click *Manage Existing Profiles* in the main window.

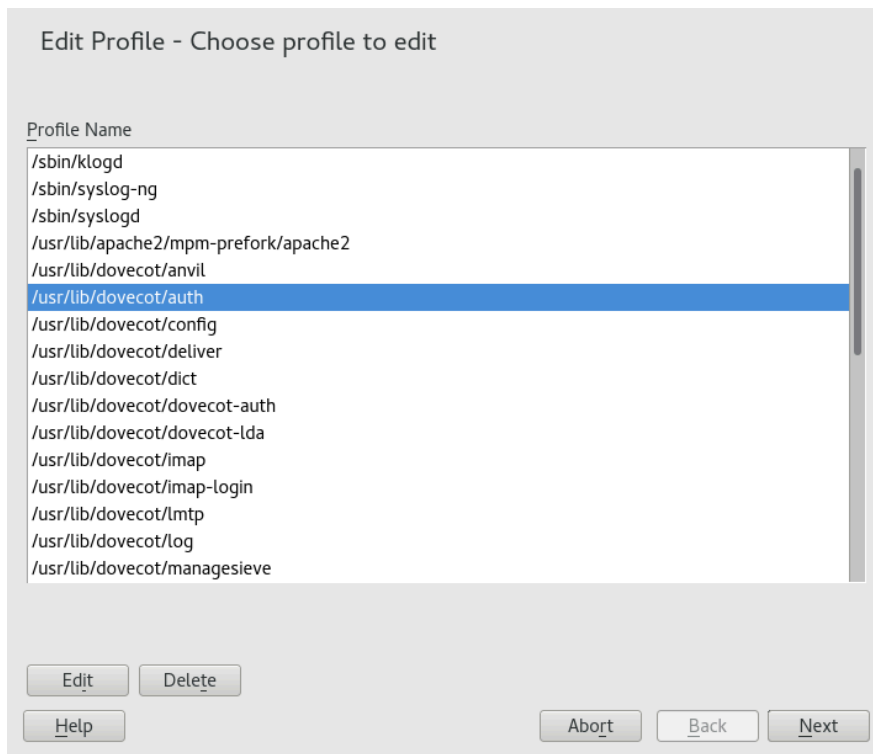

2. From the list of profiled applications, select the profile to edit.
3. Click *Edit*. The *AppArmor Profile Dialog* window displays the profile.

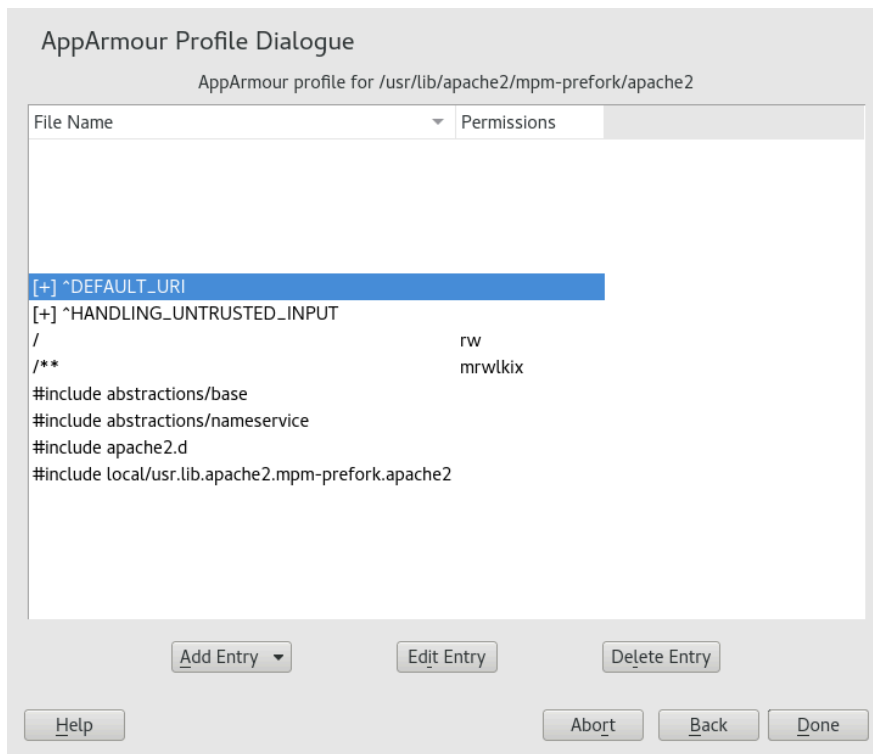

4. In the *AppArmor Profile Dialog* window, add, edit, or delete AppArmor profile entries by clicking the corresponding buttons and referring to [Section 36.2.1, “Adding an entry”](#), [Section 36.2.2, “Editing an entry”](#), or [Section 36.2.3, “Deleting an entry”](#).
5. When you are finished, click *Done*.
6. In the pop-up that appears, click *Yes* to confirm your changes to the profile and reload the AppArmor profile set.



Tip: Syntax checking in AppArmor

AppArmor contains a syntax check that notifies you of any syntax errors in profiles you are trying to process with the YaST AppArmor tools. If an error occurs, edit the profile manually as `root` and reload the profile set with `systemctl reload apparmor`.

36.2.1 Adding an entry

The *Add Entry* button in the *AppArmor Profile Window* lists types of entries you can add to the AppArmor profile.

From the list, select one of the following:

File

In the pop-up window, specify the absolute path of a file, including the type of access permitted. When finished, click *OK*.

You can use globbing if necessary. For globbing information, refer to [Section 34.6, “Profile names, flags, paths, and globbing”](#). For file access permission information, refer to [Section 34.7, “File permission access modes”](#).

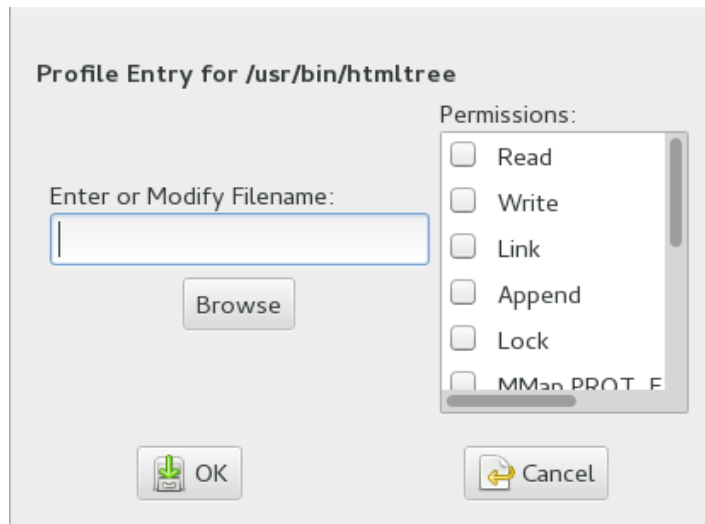

Directory

In the pop-up window, specify the absolute path of a directory, including the type of access permitted. You can use globbing if necessary. When finished, click *OK*.

For globbing information, refer to [Section 34.6, “Profile names, flags, paths, and globbing”](#). For file access permission information, refer to [Section 34.7, “File permission access modes”](#).

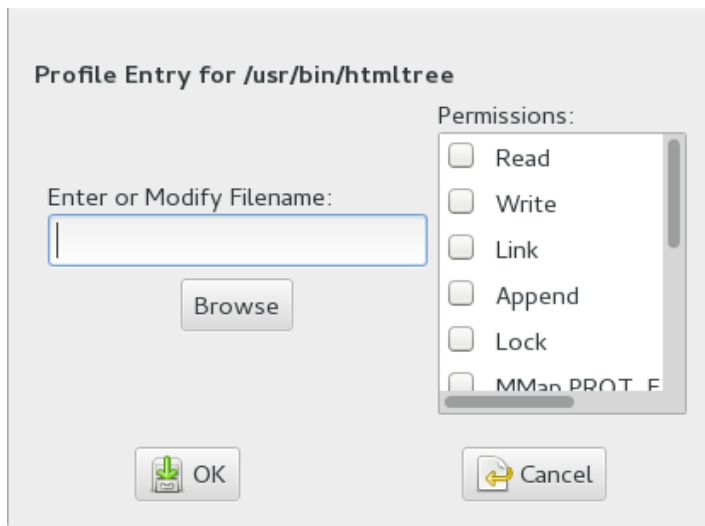

Network rule

In the pop-up window, select the appropriate network family and the socket type. For more information, refer to [Section 34.5, "Network access control"](#).

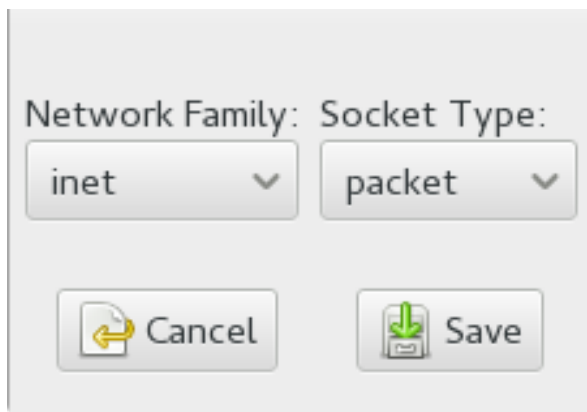

Capability

In the pop-up window, select the appropriate capabilities. These are statements that enable each of the 32 POSIX.1e capabilities. Refer to [Section 34.4, "Capability entries \(POSIX.1e\)"](#) for more information about capabilities. When finished making your selections, click *OK*.

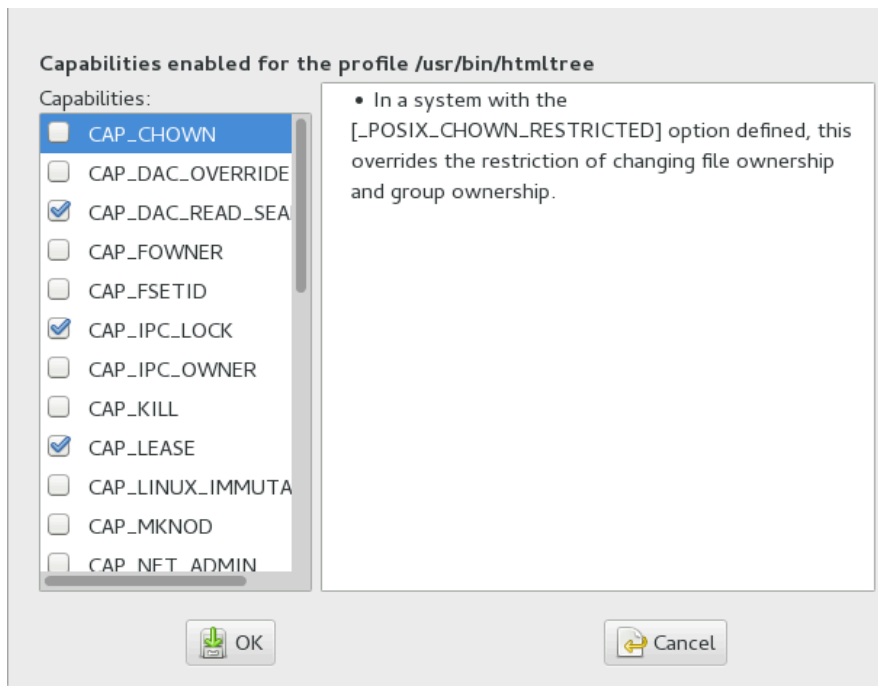

Include file

In the pop-up window, browse to the files to use as includes. Includes are directives that pull in components of other AppArmor profiles to simplify profiles. For more information, refer to [Section 34.3, "Include statements"](#).

Hat

In the pop-up window, specify the name of the subprofile (*hat*) to add to your current profile and click *Create Hat*. For more information, refer to [Chapter 38, Profiling your Web applications using ChangeHat](#).

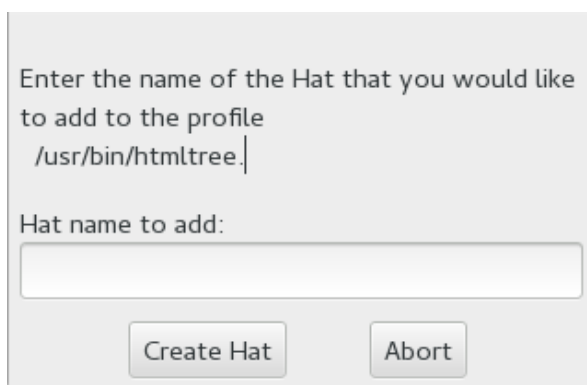

36.2.2 Editing an entry

When you select *Edit Entry*, a pop-up window opens. From here, edit the selected entry.

In the pop-up window, edit the entry you need to modify. You can use globbing if necessary. When finished, click *OK*.

For globbing information, refer to [Section 34.6, "Profile names, flags, paths, and globbing"](#). For access permission information, refer to [Section 34.7, "File permission access modes"](#).

36.2.3 Deleting an entry

To delete an entry in a given profile, select *Delete Entry*. AppArmor removes the selected profile entry.

36.3 Deleting a profile

AppArmor enables you to delete an AppArmor profile manually. Simply select the application for which to delete a profile then delete it as follows:

1. Start YaST, select *AppArmor Configuration*, and click *Manage Existing Profiles* in the main window.
2. Select the profile to delete.
3. Click *Delete*.
4. In the pop-up that opens, click *Yes* to delete the profile and reload the AppArmor profile set.

36.4 Managing AppArmor

You can change the status of AppArmor by enabling or disabling it. Enabling AppArmor protects your system from potential program exploitation. Disabling AppArmor, even if your profiles have been set up, removes protection from your system. To change the status of AppArmor, start YaST, select *AppArmor Configuration*, and click *Settings* in the main window.

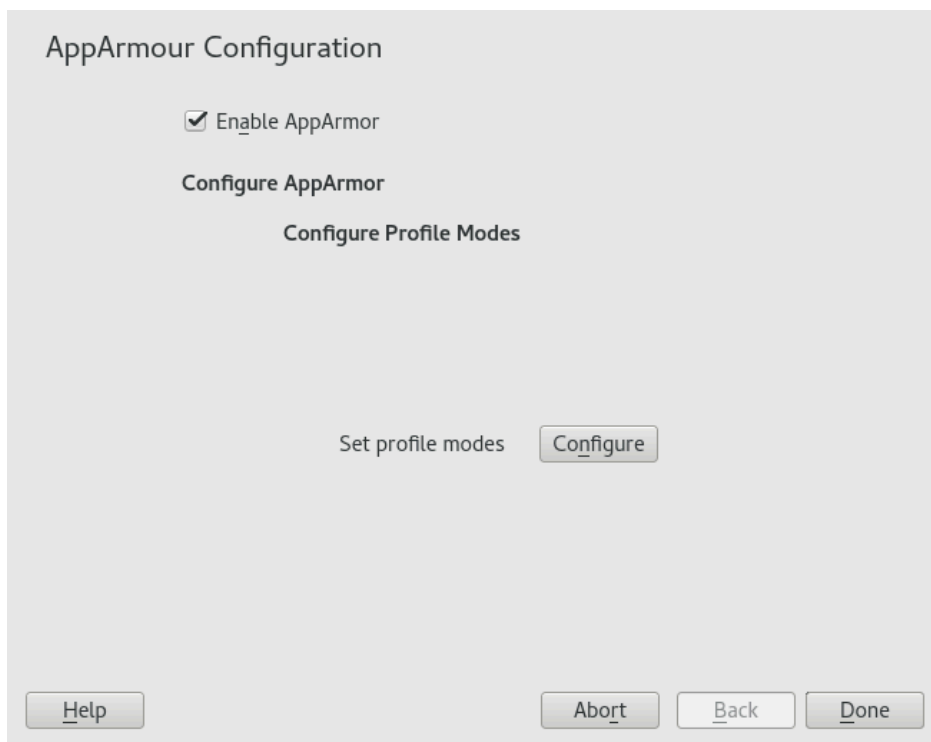

To change the status of AppArmor, continue as described in [Section 36.4.1, “Changing AppArmor status”](#). To change the mode of individual profiles, continue as described in [Section 36.4.2, “Changing the mode of individual profiles”](#).

36.4.1 Changing AppArmor status

When you change the status of AppArmor, set it to enabled or disabled. When AppArmor is enabled, it is installed, running and enforcing the AppArmor security policies.

1. Start YaST, select *AppArmor Configuration*, and click *Settings* in the main window.
2. Enable AppArmor by checking *Enable AppArmor* or disable AppArmor by deselecting it.
3. Click *Done* in the *AppArmor Configuration* window.



Tip

You always need to restart running programs to apply the profiles to them.

36.4.2 Changing the mode of individual profiles

AppArmor can apply profiles in two different modes. In *complain* mode, violations of AppArmor profile rules, such as the profiled program accessing files not permitted by the profile, are detected. The violations are permitted, but also logged. This mode is convenient for developing profiles and is used by the AppArmor tools for generating profiles. Loading a profile in *enforce* mode enforces the policy defined in the profile, and reports policy violation attempts to `rsyslogd` (or `auditd` or `journalctl`, depending on system configuration).

The *Profile Mode Configuration* dialog allows you to view and edit the mode of currently loaded AppArmor profiles. This feature is useful for determining the status of your system during profile development. During systemic profiling (see [Section 37.7.2, “Systemic profiling”](#)), you can use this tool to adjust and monitor the scope of the profiles for which you are learning behavior.

To edit an application's profile mode, proceed as follows:

1. Start YaST, select *AppArmor Configuration*, and click *Settings* in the main window.
2. In the *Configure Profile Modes* section, select *Configure*.
3. Select the profile for which to change the mode.
4. Select *Toggle Mode* to set this profile to *complain* mode or to *enforce* mode.
5. Apply your settings and leave YaST with *Done*.

To change the mode of all profiles, use *Set All to Enforce* or *Set All to Complain*.



Tip: Listing the profiles available

By default, only active profiles are listed (any profile that has a matching application installed on your system). To set up a profile before installing the respective application, click *Show All Profiles* and select the profile to configure from the list that appears.

37 Building profiles from the command line

AppArmor® provides the user the ability to use a command line interface rather than a graphical interface to manage and configure the system security. Track the status of AppArmor and create, delete or modify AppArmor profiles using the AppArmor command line tools.



Tip: Background information

Before starting to manage your profiles using the AppArmor command line tools, check out the general introduction to AppArmor given in [Chapter 33, Immunizing programs](#) and [Chapter 34, Profile components and syntax](#).

37.1 Checking the AppArmor status

AppArmor can be in any one of three states:

Unloaded

AppArmor is not activated in the kernel.

Running

AppArmor is activated in the kernel and is enforcing AppArmor program policies.

Stopped

AppArmor is activated in the kernel, but no policies are enforced.

Detect the state of AppArmor by inspecting `/sys/kernel/security/apparmor/profiles`. If `cat /sys/kernel/security/apparmor/profiles` reports a list of profiles, AppArmor is running. If it is empty and returns nothing, AppArmor is stopped. If the file does not exist, AppArmor is unloaded.

Manage AppArmor with `systemctl`. It lets you perform the following operations:

`sudo systemctl start apparmor`

Behavior depends on the state of AppArmor. If it is not activated, `start` activates and starts it, putting it in the running state. If it is stopped, `start` causes the re-scan of AppArmor profiles found in `/etc/apparmor.d` and puts AppArmor in the running state. If AppArmor is already running, `start` reports a warning and takes no action.



Note: Already running processes

Already running processes need to be restarted to apply the AppArmor profiles on them.

`sudo systemctl stop apparmor`

Stops AppArmor if it is running by removing all profiles from kernel memory, effectively disabling all access controls, and putting AppArmor into the stopped state. If the AppArmor is already stopped, `stop` tries to unload the profiles again, but nothing happens.

`sudo systemctl reload apparmor`

Causes the AppArmor module to re-scan the profiles in `/etc/apparmor.d` without unconfining running processes. Freshly created profiles are enforced and recently deleted ones are removed from the `/etc/apparmor.d` directory.

37.2 Building AppArmor profiles

The AppArmor module profile definitions are stored in the `/etc/apparmor.d` directory as plain text files. For a detailed description of the syntax of these files, refer to [Chapter 34, Profile components and syntax](#).

All files in the `/etc/apparmor.d` directory are interpreted as profiles and are loaded as such. Renaming files in that directory is not an effective way of preventing profiles from being loaded. You must remove profiles from this directory to prevent them from being read and evaluated effectively, or call **`aa-disable`** on the profile, which creates a symbolic link in `/etc/apparmor.d/disabled/`.

You can use a text editor, such as **`vi`**, to access and make changes to these profiles. The following sections contain detailed steps for building profiles:

Adding or creating AppArmor profiles

Refer to [Section 37.3, “Adding or creating an AppArmor profile”](#)

Editing AppArmor profiles

Refer to [Section 37.4, “Editing an AppArmor profile”](#)

Deleting AppArmor profiles

Refer to [Section 37.6, “Deleting an AppArmor profile”](#)

37.3 Adding or creating an AppArmor profile

To add or create an AppArmor profile for an application, you can use a systemic or stand-alone profiling method, depending on your needs. Learn more about these two approaches in [Section 37.7, “Two methods of profiling”](#).

37.4 Editing an AppArmor profile

The following steps describe the procedure for editing an AppArmor profile:

1. If you are not currently logged in as `root`, enter `su` in a terminal window.
2. Enter the `root` password when prompted.
3. Go to the profile directory with `cd /etc/apparmor.d/`.
4. Enter `ls` to view all profiles currently installed.
5. Open the profile to edit in a text editor, such as vim.
6. Make the necessary changes, then save the profile.
7. Restart AppArmor by entering `systemctl reload apparmor` in a terminal window.

37.5 Unloading unknown AppArmor profiles



Warning: Danger of unloading wanted profiles

`aa-remove-unknown` unloads all profiles that are not stored in `/etc/apparmor.d/`, for example automatically generated LXD profiles. This may compromise the security of the system. Use the `-n` parameter to list all profiles that are unloaded.

To unload all AppArmor profiles that are no longer in `/etc/apparmor.d/`, run:

```
> sudo aa-remove-unknown
```

You can print a list of profiles that are removed:

```
> sudo aa-remove-unknown -n
```

37.6 Deleting an AppArmor profile

The following steps describe the procedure for deleting an AppArmor profile.

1. Remove the AppArmor definition from the kernel:

```
> sudo apparmor_parser -R /etc/apparmor.d/PROFILE
```

2. Remove the definition file:

```
> sudo rm /etc/apparmor.d/PROFILE
> sudo rm /var/lib/apparmor/cache/PROFILE
```

37.7 Two methods of profiling

Given the syntax for AppArmor profiles in [Chapter 34, Profile components and syntax](#), you could create profiles without using the tools. However, the effort involved would be substantial. To avoid such a situation, use the AppArmor tools to automate the creation and refinement of profiles.

There are two ways to approach AppArmor profile creation. Tools are available for both methods.

Stand-alone profiling

A method suitable for profiling small applications that have a finite runtime, such as user client applications like mail clients. For more information, refer to [Section 37.7.1, “Stand-alone profiling”](#).

Systemic profiling

A method suitable for profiling many programs at once and for profiling applications that may run for days, weeks or continuously across reboots, such as network server applications like Web servers and mail servers. For more information, refer to [Section 37.7.2, “Systemic profiling”](#).

Automated profile development becomes more manageable with the AppArmor tools:

1. Decide which profiling method suits your needs.
2. Perform a static analysis. Run either `aa-genprof` or `aa-autodep`, depending on the profiling method chosen.
3. Enable dynamic learning. Activate learning mode for all profiled programs.

37.7.1 Stand-alone profiling

Stand-alone profile generation and improvement is managed by a program called **aa-genprof**. This method is easy because **aa-genprof** takes care of everything, but is limited because it requires **aa-genprof** to run for the entire duration of the test run of your program (you cannot reboot the machine while you are still developing your profile).

To use **aa-genprof** for the stand-alone method of profiling, refer to [Section 37.7.3.8, “aa-genprof—generating profiles”](#).

37.7.2 Systemic profiling

This method is called *systemic profiling* because it updates all the profiles on the system at once, rather than focusing on the one or few targeted by **aa-genprof** or stand-alone profiling. With systemic profiling, profile construction and improvement are less automated, but more flexible. This method is suitable for profiling long-running applications whose behavior continues after rebooting, or many programs at once.

Build an AppArmor profile for a group of applications as follows:

1. Create profiles for the individual programs that make up your application.

Although this approach is systemic, AppArmor monitors those programs with profiles and their children. To get AppArmor to consider a program, you must at least have **aa-autodep** create an approximate profile for it. To create this approximate profile, refer to [Section 37.7.3.1, “aa-autodep—creating approximate profiles”](#).

2. Put relevant profiles into learning or complain mode.

Activate learning or complain mode for all profiled programs by entering

```
> sudo aa-complain /etc/apparmor.d/*
```

in a terminal window while logged in as **root**. This functionality is also available through the YaST Profile Mode module, described in [Section 36.4.2, “Changing the mode of individual profiles”](#).

When in learning mode, access requests are not blocked, even if the profile dictates that they should be. This enables you to run through several tests (as shown in [Step 3](#)) and learn the access needs of the program so it runs properly. With this information, you can decide how secure to make the profile.

Refer to [Section 37.7.3.2, “aa-complain—entering complain or learning mode”](#) for more detailed instructions for using learning or complain mode.

3. Exercise your application.

Run your application and exercise its functionality. How much to exercise the program is up to you, but you need the program to access each file representing its access needs. Because the execution is not being supervised by **aa-genprof**, this step can go on for days or weeks and can span complete system reboots.

4. Analyze the log.

In systemic profiling, run **aa-logprof** directly instead of letting **aa-genprof** run it (as in stand-alone profiling). The general form of **aa-logprof** is:

```
> sudo aa-logprof [ -d /path/to/profiles ] [ -f /path/to/logfile ]
```

Refer to [Section 37.7.3.9, “aa-logprof—scanning the system log”](#) for more information about using **aa-logprof**.

5. Repeat [Step 3](#) and [Step 4](#).

This generates optimal profiles. An iterative approach captures smaller data sets that can be trained and reloaded into the policy engine. Subsequent iterations generate fewer messages and run faster.

6. Edit the profiles.

You should review the profiles that have been generated. You can open and edit the profiles in `/etc/apparmor.d/` using a text editor.

7. Return to enforce mode.

This is when the system goes back to enforcing the rules of the profiles, not only logging information. This can be done manually by removing the `flags=(complain)` text from the profiles or automatically by using the **aa-enforce** command, which works identically to the **aa-complain** command, except it sets the profiles to enforce mode. This functionality is also available through the YaST Profile Mode module, described in [Section 36.4.2, “Changing the mode of individual profiles”](#).

To ensure that all profiles are taken out of complain mode and put into enforce mode, enter **aa-enforce /etc/apparmor.d/***.

8. Re-scan all profiles.

To have AppArmor re-scan all the profiles and change the enforcement mode in the kernel, enter **systemctl reload apparmor**.

37.7.3 Summary of profiling tools

All of the AppArmor profiling utilities are provided by the `apparmor-utils` RPM package and are stored in `/usr/sbin`. Each tool has a different purpose.

37.7.3.1 `aa-autodep`—creating approximate profiles

This creates an approximate profile for the program or application selected. You can generate approximate profiles for binary executables and interpreted script programs. The resulting profile is called “approximate” because it does not necessarily contain all of the profile entries that the program needs to be properly confined by AppArmor. The minimum `aa-autodep` approximate profile has, at minimum, a base include directive, which contains basic profile entries needed by most programs. For certain types of programs, `aa-autodep` generates a more expanded profile. The profile is generated by recursively calling `ldd(1)` on the executables listed on the command line.

To generate an approximate profile, use the `aa-autodep` program. The program argument can be either the simple name of the program, which `aa-autodep` finds by searching your shell's path variable, or it can be a fully qualified path. The program itself can be of any type (ELF binary, shell script, Perl script, etc.). `aa-autodep` generates an approximate profile to improve through the dynamic profiling that follows.

The resulting approximate profile is written to the `/etc/apparmor.d` directory using the AppArmor profile naming convention of naming the profile after the absolute path of the program, replacing the forward slash (`/`) characters in the path with period (`.`) characters. The general syntax of `aa-autodep` is to enter the following in a terminal window:

```
> sudo aa-autodep [ -d /PATH/TO/PROFILES ] [PROGRAM1 PROGRAM2...]
```

If you do not enter the program name or names, you are prompted for them. `/path/to/profiles` overrides the default location of `/etc/apparmor.d`, should you keep profiles in a location other than the default.

To begin profiling, you must create profiles for each main executable service that is part of your application (anything that might start without being a child of another program that already has a profile). Finding all such programs depends on the application in question. Here are several strategies for finding such programs:

Directories

If all the programs to profile are in one directory and there are no other programs in that directory, the simple command `aa-autodep /path/to/your/programs/*` creates basic profiles for all programs in that directory.

pstree -p

You can run your application and use the standard Linux `pstree` command to find all processes running. Then manually hunt down the location of these programs and run the `aa-autodep` for each one. If the programs are in your path, `aa-autodep` finds them for you. If they are not in your path, the standard Linux command `find` might be helpful in finding your programs. Execute `find / -name 'MY_APPLICATION' -print` to determine an application's path (`MY_APPLICATION` being an example application). You may use wild cards if appropriate.

37.7.3.2 aa-complain—entering complain or learning mode

The complain or learning mode tool (`aa-complain`) detects violations of AppArmor profile rules, such as the profiled program accessing files not permitted by the profile. The violations are permitted, but also logged. To improve the profile, turn complain mode on, run the program through a suite of tests to generate log events that characterize the program's access needs, then postprocess the log with the AppArmor tools to transform log events into improved profiles.

Manually activating complain mode (using the command line) adds a flag to the top of the profile so that `/bin/foo` becomes `/bin/foo flags=(complain)`. To use complain mode, open a terminal window and enter one of the following lines as `root`:

- If the example program (`PROGRAM1`) is in your path, use:

```
> sudo aa-complain [PROGRAM1 PROGRAM2 ...]
```

- If the program is not in your path, specify the entire path as follows:

```
> sudo aa-complain /sbin/PROGRAM1
```

- If the profiles are not in `/etc/apparmor.d`, use the following to override the default location:

```
> sudo aa-complain /path/to/profiles/PROGRAM1
```

- Specify the profile for `/sbin/program1` as follows:

```
> sudo aa-complain /etc/apparmor.d/sbin.PROGRAM1
```

Each of the above commands activates the complain mode for the profiles or programs listed. If the program name does not include its entire path, **aa-complain** searches `$PATH` for the program. For example, **aa-complain /usr/sbin/*** finds profiles associated with all the programs in `/usr/sbin` and puts them into complain mode. **aa-complain /etc/apparmor.d/*** puts all the profiles in `/etc/apparmor.d` into complain mode.



Tip: Toggling profile mode with YaST

YaST offers a graphical front-end for toggling complain and enforce mode. See [Section 36.4.2, “Changing the mode of individual profiles”](#) for information.

37.7.3.3 **aa-decode**—decoding hex-encoded strings in AppArmor log files

aa-decode decodes hex-encoded strings in the AppArmor log output. It can also process the audit log on standard input, convert any hex-encoded AppArmor log entries, and display them on standard output.

37.7.3.4 **aa-disable**—disabling an AppArmor security profile

Use **aa-disable** to disable the enforcement mode for one or more AppArmor profiles. This command unloads the profile from the kernel and prevents the profile from being loaded on AppArmor start-up. Use **aa-enforce** or **aa-complain** utilities to change this behavior.

37.7.3.5 aa-easyprof—easy profile generation

aa-easyprof provides an easy-to-use interface for AppArmor profile generation. **aa-easyprof** supports the use of templates and profile groups to quickly profile an application. While **aa-easyprof** can help with profile generation, its utility is dependent on the quality of the templates, profile groups and abstractions used. Also, this tool may create a profile that is less restricted than when creating a profile manually or with **aa-genprof** and **aa-logprof**.

For more information, see the man page of **aa-easyprof** (8).

37.7.3.6 aa-enforce—entering enforce mode

The enforce mode detects violations of AppArmor profile rules, such as the profiled program accessing files not permitted by the profile. The violations are logged and not permitted. The default is for enforce mode to be enabled. To log the violations, but still permit them, use complain mode.

Manually activating enforce mode (using the command line) removes the complain flag from the top of the profile so that `/bin/foo flags=(complain)` becomes `/bin/foo`. To use enforce mode, open a terminal window and enter one of the following lines.

- If the example program (*PROGRAM1*) is in your path, use:

```
> sudo aa-enforce [PROGRAM1 PROGRAM2 ...]
```

- If the program is not in your path, specify the entire path, as follows:

```
> sudo aa-enforce /sbin/PROGRAM1
```

- If the profiles are not in `/etc/apparmor.d`, use the following to override the default location:

```
> sudo aa-enforce -d /path/to/profiles/ program1
```

- Specify the profile for `/sbin/program1` as follows:

```
> sudo aa-enforce /etc/apparmor.d/sbin.PROGRAM1
```

Each of the above commands activates the enforce mode for the profiles and programs listed.

If you do not enter the program or profile names, you are prompted to enter one. `/path/to/profiles` overrides the default location of `/etc/apparmor.d`.

The argument can be either a list of programs or a list of profiles. If the program name does not include its entire path, **aa-enforce** searches `$PATH` for the program.



Tip: Toggling profile mode with YaST

YaST offers a graphical front-end for toggling complain and enforce mode. See [Section 36.4.2, “Changing the mode of individual profiles”](#) for information.

37.7.3.7 **aa-exec**—confining a program with the specified profile

Use **aa-exec** to launch a program confined by a specified profile and/or profile namespace. If both a profile and namespace are specified, the program is confined by the profile in the new namespace. If a profile namespace is specified, the profile name of the current confinement is used. If neither a profile nor namespace is specified, the command runs using the standard profile attachment—as if you did not use the **aa-exec** command.

For more information on the command's options, see its manual page `man 8 aa-exec`.

37.7.3.8 **aa-genprof**—generating profiles

aa-genprof is AppArmor's profile generating utility. It runs **aa-autodep** on the specified program, creating an approximate profile (if a profile does not already exist for it), sets it to complain mode, reloads it into AppArmor, marks the log, and prompts the user to execute the program and exercise its functionality. Its syntax is as follows:

```
> sudo aa-genprof [ -d /path/to/profiles ] PROGRAM
```

To create a profile for the Apache Web server program `httpd2-prefork`, do the following as `root`:

1. Enter `systemctl stop apache2`.
2. Next, enter `aa-genprof httpd2-prefork`.

Now **aa-genprof** does the following:

1. Resolves the full path of `httpd2-prefork` using your shell's path variables. You can also specify a full path. On SUSE Linux Enterprise Server, the default full path is `/usr/sbin/httpd2-prefork`.
2. Checks to see if there is an existing profile for `httpd2-prefork`. If there is one, it updates it. If not, it creates one using the **aa-autodep** as described in [Section 37.7.3, "Summary of profiling tools"](#).
3. Puts the profile for this program into learning or complain mode so that profile violations are logged, but are permitted to proceed. A log event looks like this (see `/var/log/audit/audit.log`):

```
type=APPARMOR_ALLOWED msg=audit(1189682639.184:20816): \
apparmor="DENIED" operation="file_mmap" parent=2692 \
profile="/usr/sbin/httpd2-prefork//HANDLING_UNTRUSTED_INPUT" \
name="/var/log/apache2/access_log-20140116" pid=28730 comm="httpd2-prefork" \
requested_mask="::r" denied_mask="::r" fsuid=30 ouid=0
```

If you are not running the audit daemon, the AppArmor events are logged directly to `systemd journal` (see *Book "Administration Guide", Chapter 21 "journalctl: query the systemd journal"*):

```
Sep 13 13:20:30 K23 kernel: audit(1189682430.672:20810): \
apparmor="DENIED" operation="file_mmap" parent=2692 \
profile="/usr/sbin/httpd2-prefork//HANDLING_UNTRUSTED_INPUT" \
name="/var/log/apache2/access_log-20140116" pid=28730 comm="httpd2-prefork" \
requested_mask="::r" denied_mask="::r" fsuid=30 ouid=0
```

They also can be viewed using the **dmesg** command:

```
audit(1189682430.672:20810): apparmor="DENIED" \
operation="file_mmap" parent=2692 \
profile="/usr/sbin/httpd2-prefork//HANDLING_UNTRUSTED_INPUT" \
name="/var/log/apache2/access_log-20140116" pid=28730 comm="httpd2-prefork" \
requested_mask="::r" denied_mask="::r" fsuid=30 ouid=0
```

4. Marks the log with a beginning marker of log events to consider. For example:

```
Sep 13 17:48:52 figwit root: GenProf: e2ff78636296f16d0b5301209a04430d
```

3. When prompted by the tool, run the application to profile in another terminal window and perform as many of the application functions as possible. Thus, the learning mode can log the files and directories to which the program requires access to function properly. For example, in a new terminal window, enter `systemctl start apache2`.
4. Select from the following options that are available in the `aa-genprof` terminal window after you have executed the program function:
 - **S** runs `aa-genprof` on the system log from where it was marked when `aa-genprof` was started and reloads the profile. If system events exist in the log, AppArmor parses the learning mode log files. This generates a series of questions that you must answer to guide `aa-genprof` in generating the security profile.
 - **F** exits the tool.



Note

If requests to add hats appear, proceed to [Chapter 38, Profiling your Web applications using ChangeHat](#).

5. Answer two types of questions:
 - A resource is requested by a profiled program that is not in the profile (see [Example 37.1, “Learning mode exception: controlling access to specific resources”](#)).
 - A program is executed by the profiled program and the security domain transition has not been defined (see [Example 37.2, “Learning mode exception: defining permissions for an entry”](#)).

Each of these categories results in a series of questions that you must answer to add the resource or program to the profile. [Example 37.1, “Learning mode exception: controlling access to specific resources”](#) and [Example 37.2, “Learning mode exception: defining permissions for an entry”](#) provide examples of each one. Subsequent steps describe your options in answering these questions.

- Dealing with execute accesses is complex. You must decide how to proceed with this entry regarding which execute permission type to grant to this entry:

EXAMPLE 37.1: LEARNING MODE EXCEPTION: CONTROLLING ACCESS TO SPECIFIC RESOURCES

```
Reading log entries from /var/log/audit/audit.log.
```

```
Updating AppArmor profiles in /etc/apparmor.d.
```

```
Profile: /usr/sbin/cupsd  
Program: cupsd  
Execute: /usr/lib/cups/daemon/cups-lpd  
Severity: unknown
```

```
(I)nherit / (P)rofile / (C)hild / (N)ame / (U)nconfined / (X)ix / (D)eny /  
Abo(r)t / (F)inish
```

Inherit (ix)

The child inherits the parent's profile, running with the same access controls as the parent. This mode is useful when a confined program needs to call another confined program without gaining the permissions of the target's profile or losing the permissions of the current profile. This mode is often used when the child program is a *helper application*, such as the `/usr/bin/mail` client using `less` as a pager.

Profile (px/px)

The child runs using its own profile, which must be loaded into the kernel. If the profile is not present, attempts to execute the child fail with permission denied. This is most useful if the parent program is invoking a global service, such as DNS lookups or sending mail with your system's MTA.

Choose the *profile with clean exec* (Px) option to scrub the environment of environment variables that could modify execution behavior when passed to the child process.

Child (cx/cx)

Sets up a transition to a subprofile. It is like px/Px transition, except to a child profile.

Choose the *profile with clean exec* (Cx) option to scrub the environment of environment variables that could modify execution behavior when passed to the child process.

Unconfined (ux/ux)

The child runs unconfined without any AppArmor profile applied to the executed resource.

Choose the *unconfined with clean exec* (Ux) option to scrub the environment of environment variables that could modify execution behavior when passed to the child process. Running unconfined profiles introduces a security vulnerability that could be used to evade AppArmor. Use it as a last resort.

mmap (m)

This permission denotes that the program running under the profile can access the resource using the mmap system call with the flag `PROT_EXEC`. This means that the data mapped in it can be executed. You are prompted to include this permission if it is requested during a profiling run.

Deny

Adds a `deny` rule to the profile, and permanently prevents the program from accessing the specified directory path entries. AppArmor then continues to the next event.

Abort

Aborts `aa-logprof`, losing all rule changes entered so far and leaving all profiles unmodified.

Finish

Closes `aa-logprof`, saving all rule changes entered so far and modifying all profiles.

- *Example 37.2, "Learning mode exception: defining permissions for an entry"* shows AppArmor suggest allowing a globbing pattern `/var/run/nscd/*` for reading, then using an abstraction to cover common Apache-related access rules.

EXAMPLE 37.2: LEARNING MODE EXCEPTION: DEFINING PERMISSIONS FOR AN ENTRY

```
Profile: /usr/sbin/httpd2-prefork
Path:    /var/run/nscd/dbSz9CTr
Mode:    r
Severity: 3

  1 - /var/run/nscd/dbSz9CTr
  [2 - /var/run/nscd/*]

(A)llow / [(D)eny] / (G)lob / Glob w/(E)xt / (N)ew / Abo(r)t / (F)inish /
(O)pts
Adding /var/run/nscd/* r to profile.

Profile: /usr/sbin/httpd2-prefork
Path:    /proc/11769/attr/current
Mode:    w
Severity: 9

  [1 - #include <abstractions/apache2-common>]
  2 - /proc/11769/attr/current
  3 - /proc/*/attr/current

(A)llow / [(D)eny] / (G)lob / Glob w/(E)xt / (N)ew / Abo(r)t / (F)inish /
(O)pts
Adding #include <abstractions/apache2-common> to profile.
```

AppArmor provides one or more paths or includes. By entering the option number, select the desired options then proceed to the next step.



Note

Not all these options are always presented in the AppArmor menu.

#include

This is the section of an AppArmor profile that refers to an include file, which procures access permissions for programs. By using an include, you can give the program access to directory paths or files that are also required by other programs. Using includes can reduce the size of a profile. It is good practice to select includes when suggested.

Globbed version

This is accessed by selecting *Glob* as described in the next step. For information about globbing syntax, refer to [Section 34.6, "Profile names, flags, paths, and globbing"](#).

Actual path

This is the literal path to which the program needs access so that it can run properly.

After you select the path or include, process it as an entry into the AppArmor profile by selecting *Allow* or *Deny*. If you are not satisfied with the directory path entry as it is displayed, you can also *Glob* it.

The following options are available to process the learning mode entries and build the profile:

Select **Enter**

Allows access to the selected directory path.

Allow

Allows access to the specified directory path entries. AppArmor suggests file permission access. For more information, refer to [Section 34.7, "File permission access modes"](#).

Deny

Prevents the program from accessing the specified directory path entries. AppArmor then continues to the next event.

New

Prompts you to enter your own rule for this event, allowing you to specify a regular expression. If the expression does not actually satisfy the event that prompted the question in the first place, AppArmor asks for confirmation and lets you reenter the expression.

Glob

Select a specific path or create a general rule using wild cards that match a broader set of paths. To select any of the offered paths, enter the number that is printed in front of the path then decide how to proceed with the selected item. For more information about globbing syntax, refer to [Section 34.6, "Profile names, flags, paths, and globbing"](#).

Glob w/ext

This modifies the original directory path while retaining the file name extension. For example, `/etc/apache2/file.ext` becomes `/etc/apache2/*.ext`, adding the wild card (asterisk) in place of the file name. This allows the program to access all files in the suggested directory that end with the `.ext` extension.

Abort

Aborts `aa-logprof`, losing all rule changes entered so far and leaving all profiles unmodified.

Finish

Closes `aa-logprof`, saving all rule changes entered so far and modifying all profiles.

6. To view and edit your profile using `vi`, enter `vi /etc/apparmor.d/ PROFILENAME` in a terminal window. To enable syntax highlighting when editing an AppArmor profile in vim, use the commands `:syntax on` then `:set syntax=apparmor`. For more information about vim and syntax highlighting, refer to [Section 37.7.3.14, "apparmor.vim"](#).
7. Restart AppArmor and reload the profile set including the newly created one using the `systemctl reload apparmor` command.

Like the graphical front-end for building AppArmor profiles, the YaST Add Profile Wizard, `aa-genprof` also supports the use of the local profile repository under `/usr/share/apparmor/extra-profiles`.

To use a profile from the local repository, proceed as follows:

1. Start `aa-genprof` as described above.

If `aa-genprof` finds an inactive local profile, the following lines appear on your terminal window:

```
Profile: /usr/bin/opera

[1 - Inactive local profile for /usr/bin/opera]

[(V)iew Profile] / (U)se Profile / (C)reate New Profile / Abo(r)t / (F)inish
```

2. To use this profile, press `U` (*Use Profile*) and follow the profile generation procedure outlined above.

To examine the profile before activating it, press **V** (*View Profile*).

To ignore the existing profile, press **C** (*Create New Profile*) and follow the profile generation procedure outlined above to create the profile from scratch.

3. Leave **aa-genprof** by pressing **F** (*Finish*) when you are done and save your changes.

37.7.3.9 aa-logprof—scanning the system log

aa-logprof is an interactive tool used to review the complain and enforce mode events found in the log entries in `/var/log/audit/audit.log`, or directly in the `systemd` journal (see *Book "Administration Guide", Chapter 21 "journalctl: query the systemd journal"*), and generate new entries in AppArmor security profiles.

When you run **aa-logprof**, it begins to scan the log files produced in complain and enforce mode and, if there are new security events that are not covered by the existing profile set, it gives suggestions for modifying the profile. **aa-logprof** uses this information to observe program behavior.

If a confined program forks and executes another program, **aa-logprof** sees this and asks the user which execution mode should be used when launching the child process. The execution modes `ix`, `px`, `Px`, `ux`, `Ux`, `cx`, `Cx`, and named profiles, are options for starting the child process. If a separate profile exists for the child process, the default selection is `Px`. If one does not exist, the profile defaults to `ix`. Child processes with separate profiles have **aa-autodep** run on them and are loaded into AppArmor, if it is running.

When **aa-logprof** exits, profiles are updated with the changes. If AppArmor is active, the updated profiles are reloaded and, if any processes that generated security events are still running in the null-XXXX profiles (unique profiles temporarily created in complain mode), those processes are set to run under their proper profiles.

To run **aa-logprof**, enter **aa-logprof** into a terminal window while logged in as `root`. The following options can be used for **aa-logprof**:

aa-logprof -d /path/to/profile/directory/

Specifies the full path to the location of the profiles if the profiles are not located in the standard directory, `/etc/apparmor.d/`.

aa-logprof -f /path/to/logfile/

Specifies the full path to the location of the log file if the log file is not located in the default directory or `/var/log/audit/audit.log`.

aa-logprof -m "string marker in logfile"

Marks the starting point for **aa-logprof** to look in the system log. **aa-logprof** ignores all events in the system log before the specified mark. If the mark contains spaces, it must be surrounded by quotes to work correctly. For example:

```
# aa-logprof -m "17:04:21"
```

or

```
# aa-logprof -m e2ff78636296f16d0b5301209a04430d
```

aa-logprof scans the log, asking you how to handle each logged event. Each question presents a numbered list of AppArmor rules that can be added by pressing the number of the item on the list.

By default, **aa-logprof** looks for profiles in `/etc/apparmor.d/`. Often running **aa-logprof** as `root` is enough to update the profile. However, there might be times when you need to search archived log files, such as if the program exercise period exceeds the log rotation window (when the log file is archived and a new log file is started). If this is the case, you can enter **zcat -f `ls -ltr /path/to/logfile*` | aa-logprof -f -**.

37.7.3.10 **aa-logprof example 1**

The following is an example of how **aa-logprof** addresses `httpd2-prefork` accessing the file `/etc/group`. `[]` indicates the default option.

In this example, the access to `/etc/group` is part of `httpd2-prefork` accessing name services. The appropriate response is `1`, which includes a predefined set of AppArmor rules. Selecting `1` to `#include` the name service package resolves all of the future questions pertaining to DNS lookups and makes the profile less brittle in that any changes to DNS configuration and the associated name service profile package can be made once, rather than needing to revise many profiles.

```
Profile: /usr/sbin/httpd2-prefork
Path: /etc/group
New Mode: r

[1 - #include <abstractions/nameservice>]
 2 - /etc/group
[(A)llow] / (D)eny / (N)ew / (G)lob / Glob w/(E)xt / Abo(r)t / (F)inish
```

Select one of the following responses:

Select `Enter`

Triggers the default action, which is, in this example, allowing access to the specified directory path entry.

Allow

Allows access to the specified directory path entries. AppArmor suggests file permission access. For more information about this, refer to [Section 34.7, "File permission access modes"](#).

Deny

Permanently prevents the program from accessing the specified directory path entries. AppArmor then continues to the next event.

New

Prompts you to enter your own rule for this event, allowing you to specify whatever form of regular expression you want. If the expression entered does not satisfy the event that prompted the question in the first place, AppArmor asks for confirmation and lets you reenter the expression.

Glob

Select either a specific path or create a general rule using wild cards that matches on a broader set of paths. To select any of the offered paths, enter the number that is printed in front of the paths then decide how to proceed with the selected item.

For more information about globbing syntax, refer to [Section 34.6, "Profile names, flags, paths, and globbing"](#).

Glob w/ext

This modifies the original directory path while retaining the file name extension. For example, `/etc/apache2/file.ext` becomes `/etc/apache2/*.ext`, adding the wild card (asterisk) in place of the file name. This allows the program to access all files in the suggested directory that end with the `.ext` extension.

Abort

Aborts `aa-logprof`, losing all rule changes entered so far and leaving all profiles unmodified.

Finish

Closes `aa-logprof`, saving all rule changes entered so far and modifying all profiles.

37.7.3.11 aa-logprof example 2

For example, when profiling vsftpd, see this question:

```
Profile: /usr/sbin/vsftpd
Path: /y2k.jpg

New Mode: r

[1 - /y2k.jpg]

(A)llow / [(D)eny] / (N)ew / (G)lob / Glob w/(E)xt / Abo(r)t / (F)inish
```

Several items of interest appear in this question. First, vsftpd is asking for a path entry at the top of the tree, even though vsftpd on SUSE Linux Enterprise Server serves FTP files from `/srv/ftp` by default. This is because vsftpd uses chroot and, for the portion of the code inside the chroot jail, AppArmor sees file accesses regarding the chroot environment rather than the global absolute path.

The second item of interest is that you should grant FTP read access to all JPEG files in the directory, so you could use `Glob w/Ext` and use the suggested path of `/*.jpg`. Doing so collapses all previous rules granting access to individual `.jpg` files and forestalls any future questions pertaining to access to `.jpg` files.

Finally, you should grant more general access to FTP files. If you select `Glob` in the last entry, **aa-logprof** replaces the suggested path of `/y2k.jpg` with `/*`. Alternatively, you should grant even more access to the entire directory tree, in which case you could use the `New` path option and enter `/**/*.jpg` (which would grant access to all `.jpg` files in the entire directory tree) or `/**` (which would grant access to all files in the directory tree).

These items deal with read accesses. Write accesses are similar, except that it is good policy to be more conservative in your use of regular expressions for write accesses. Dealing with execute accesses is more complex. Find an example in [Example 37.1, “Learning mode exception: controlling access to specific resources”](#).

In the following example, the `/usr/bin/mail` mail client is being profiled and **aa-logprof** has discovered that `/usr/bin/mail` executes `/usr/bin/less` as a helper application to “page” long mail messages. Consequently, it presents this prompt:

```
/usr/bin/nail -> /usr/bin/less
(I)nherit / (P)rofile / (C)hild / (N)ame / (U)nconfined / (X)ix / (D)eny
```



Note

The actual executable file for `/usr/bin/mail` turns out to be `/usr/bin/nail`, which is not a typographical error.

The program `/usr/bin/less` appears to be a simple one for scrolling through text that is more than one screen long and that is in fact what `/usr/bin/mail` is using it for. However, `less` is actually a large and powerful program that uses many other helper applications, such as `tar` and `rpm`.



Tip

Run `less` on a tar file or an RPM file and it shows you the inventory of these containers.

You do not want to run `rpm` automatically when reading mail messages (that leads directly to a Microsoft* Outlook-style virus attack, because RPM has the power to install and modify system programs), so, in this case, the best choice is to use *Inherit*. This results in the `less` program executed from this context running under the profile for `/usr/bin/mail`. This has two consequences:

- You need to add all the basic file accesses for `/usr/bin/less` to the profile for `/usr/bin/mail`.
- You can avoid adding the helper applications, such as `tar` and `rpm`, to the `/usr/bin/mail` profile so that when `/usr/bin/mail` runs `/usr/bin/less` in this context, the `less` program is far less dangerous than it would be without AppArmor protection. Another option is to use the Cx execute modes. For more information on execute modes, see [Section 34.12, "Execute modes"](#).

In other circumstances, you might instead want to use the *Profile* option. This has the following effects on `aa-logprof`:

- The rule written into the profile uses `px/Px`, which forces the transition to the child's own profile.
- `aa-logprof` constructs a profile for the child and starts building it, in the same way that it built the parent profile, by assigning events for the child process to the child's profile and asking the `aa-logprof` user questions. The profile is applied if you run the child as a stand-alone program.

If a confined program forks and executes another program, **aa-logprof** sees this and asks the user which execution mode should be used when launching the child process. The execution modes of inherit, profile, unconfined, child, named profile, or an option to deny the execution are presented.

If a separate profile exists for the child process, the default selection is profile. If a profile does not exist, the default is inherit. The inherit option, or `ix`, is described in [Section 34.7, “File permission access modes”](#).

The profile option indicates that the child program should run in its own profile. A secondary question asks whether to sanitize the environment that the child program inherits from the parent. If you choose to sanitize the environment, this places the execution modifier `Px` in your AppArmor profile. If you select not to sanitize, `px` is placed in the profile and no environment sanitizing occurs. The default for the execution mode is `Px` if you select profile execution mode. The unconfined execution mode is not recommended and should be used in cases where there is no other option to generate a profile for a program reliably. Selecting unconfined opens a warning dialog asking for confirmation of the choice. If you are sure and choose *Yes*, a second dialog ask whether to sanitize the environment. To use the execution mode `Ux` in your profile, select *Yes*. To use the execution mode `ux` in your profile instead, select *No*. The default value selected is `Ux` for unconfined execution mode.

Important: Running unconfined

Selecting `ux` or `Ux` is dangerous and provides no enforcement of policy (from a security perspective) of the resulting execution behavior of the child program.

37.7.3.12 `aa-unconfined`—identifying unprotected processes

The **aa-unconfined** command examines open network ports on your system, compares that to the set of profiles loaded on your system, and reports network services that do not have AppArmor profiles. It requires `root` privileges and that it not be confined by an AppArmor profile.

aa-unconfined must be run as `root` to retrieve the process executable link from the `/proc` file system. This program is susceptible to the following race conditions:

- An unlinked executable is mishandled
- A process that dies between `netstat(8)` and further checks is mishandled



Note

This program lists processes using TCP and UDP. In short, this program is unsuitable for forensics use and is provided as an aid to profiling all network-accessible processes in the lab.

37.7.3.13 `aa-notify`

`aa-notify` is a handy utility that displays AppArmor notifications in your desktop environment. This is convenient if you do not want to inspect the AppArmor log file, but rather let the desktop inform you about events that violate the policy. To enable AppArmor desktop notifications, run `aa-notify`:

```
> sudo aa-notify -p -u USERNAME --display DISPLAY_NUMBER
```

where `USERNAME` is your user name under which you are logged in, and `DISPLAY_NUMBER` is the X Window display number you are currently using, such as `:0`. The process is run in the background, and shows a notification each time a deny event happens.



Tip

The active X Window display number is saved in the `$DISPLAY` variable, so you can use `--display $DISPLAY` to avoid finding out the current display number.

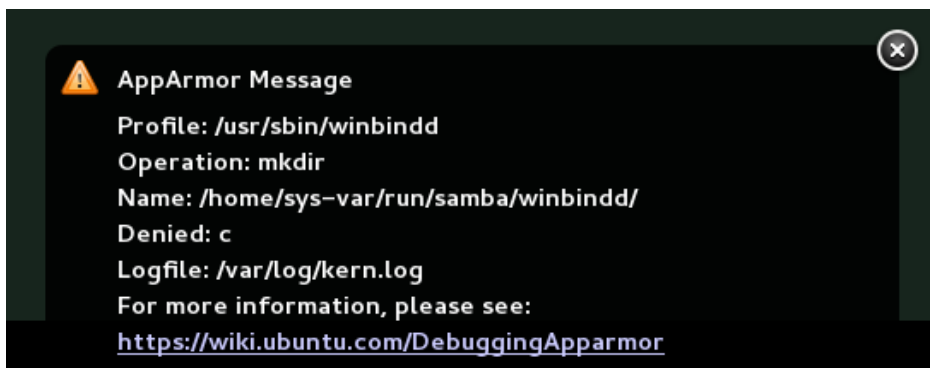

FIGURE 37.1: `aa-notify` Message in GNOME

With the `-s DAYS` option, you can also configure `aa-notify` to display a summary of notifications for the specified number of past days. For more information on `aa-notify`, see its man page `man 8 aa-notify`.

37.7.3.14 `apparmor.vim`

A syntax highlighting file for the vim text editor highlights various features of an AppArmor profile with colors. Using vim and the AppArmor syntax mode for vim, you can see the semantic implications of your profiles with color highlighting. Use vim to view and edit your profile by typing vim at a terminal window.

To enable the syntax coloring when you edit an AppArmor profile in vim, use the commands `:syntax on` then `:set syntax=apparmor`. To make sure vim recognizes the edited file type correctly as an AppArmor profile, add

```
# vim:ft=apparmor
```

at the end of the profile.



Tip

`vim` comes with AppArmor highlighting automatically enabled for files in `/etc/apparmor.d/`.

When you enable this feature, vim colors the lines of the profile for you:

Blue

Comments

White

Ordinary read access lines

Brown

Capability statements and complain flags

Yellow

Lines that grant write access

Green

Lines that grant execute permission (either ix or px)

Red

Lines that grant unconfined access (ux)

Red background

Syntax errors that do not load properly into the AppArmor modules

Use the `apparmor.vim` and `vim` man pages and the `:help syntax` from within the vim editor for further vim help about syntax highlighting. The AppArmor syntax is stored in `/usr/share/vim/current/syntax/apparmor.vim`.

37.8 Important file names and directories

The following list contains the most important files and directories used by the AppArmor framework. If you intend to manage and troubleshoot your profiles manually, make sure that you know about these files and directories:

`/sys/kernel/security/apparmor/profiles`

Virtualized file representing the currently loaded set of profiles.

`/etc/apparmor/`

Location of AppArmor configuration files.

`/usr/share/apparmor/extra-profiles`

A local repository of profiles shipped with AppArmor, but not enabled by default.

`/etc/apparmor.d/`

Location of profiles, named with the convention of replacing the `/` in paths with `.` (not for the root `/`) so profiles are easier to manage. For example, the profile for the program `/usr/sbin/smbd` is named `usr.sbin.smbd`.

`/etc/apparmor.d/abstractions/`

Location of abstractions.

`/etc/apparmor.d/program-chunks/`

Location of program chunks.

`/proc/*/attr/current`

Check this file to review the confinement status of a process and the profile that is used to confine the process. The `ps auxZ` command retrieves this information automatically.

38 Profiling your Web applications using ChangeHat

An AppArmor® profile represents the security policy for an individual program instance or process. It applies to an executable program, but if a portion of the program needs different access permissions than other portions, the program can “change hats” to use a different security context, distinctive from the access of the main program. This is known as a *hat* or *subprofile*.

ChangeHat enables programs to change to or from a *hat* within an AppArmor profile. It enables you to define security at a finer level than the process. This feature requires that each application be made “ChangeHat-aware”, meaning that it is modified to make a request to the AppArmor module to switch security domains at specific times during the application execution. One example of a ChangeHat-aware application is the Apache Web server.

A profile can have an arbitrary number of subprofiles, but there are only two levels: a subprofile cannot have further child profiles. A subprofile is written as a separate profile. Its name consists of the name of the containing profile followed by the subprofile name, separated by a `^`.

Subprofiles are either stored in the same file as the parent profile, or in a separate file. The latter case is recommended on sites with many hats—it allows the policy caching to handle changes at the per hat level. If all the hats are in the same file as the parent profile, then the parent profile and all hats must be recompiled.

An external subprofile that is going to be used as a hat, must begin with the word `hat` or the `^` character.

The following two subprofiles *cannot* be used as a hat:

```
/foo//bar { }
```

or

```
profile /foo//bar { }
```

While the following two are treated as hats:

```
^/foo//bar { }
```

or

```
hat /foo//bar { } # this syntax is not highlighted in vim
```

The security of hats is considerably weaker than that of full profiles. Using certain types of bugs in a program, an attacker may be able to escape from a hat into the containing profile. This is because the security of hats is determined by a secret key handled by the containing process,

and the code running in the hat must not have access to the key. Thus, `change_hat` is most useful with application servers, where a language interpreter (such as PERL, PHP or Java) is isolating pieces of code such that they do not have direct access to the memory of the containing process. The rest of this chapter describes using `change_hat` with Apache, to contain Web server components run using `mod_perl` and `mod_php`. Similar approaches can be used with any application server by providing an application module similar to the `mod_apparmor` described next in [Section 38.1.2, “Location and directory directives”](#).



Tip: More information

For more information, see the `change_hat` man page.

38.1 Configuring Apache for `mod_apparmor`

AppArmor provides a `mod_apparmor` module (package `apache2-mod-apparmor`) for the Apache program. This module makes the Apache Web server ChangeHat aware. Install it along with Apache.

When Apache is ChangeHat-aware, it checks for the following customized AppArmor security profiles in the order given for every URI request that it receives.

- URI-specific hat. For example, `^www_app_name/templates/classic/images/bar_left.gif`
- `DEFAULT_URI`
- `HANDLING_UNTRUSTED_INPUT`



Note: Apache configuration

If you install `apache2-mod-apparmor`, make sure the module is enabled, and then restart Apache by executing the following command:

```
> a2enmod apparmor && sudo systemctl reload apache2
```

Apache is configured by placing directives in plain text configuration files. The main configuration file is `/etc/apache2/httpd.conf`. When you compile Apache, you can indicate the location of this file. Directives can be placed in any of these configuration files to alter the way Apache behaves. When you make changes to the main configuration files, you need to reload Apache with `sudo systemctl reload apache2`, so the changes are recognized.

38.1.1 Virtual host directives

`<VirtualHost>` and `</VirtualHost>` directives are used to enclose a group of directives that applies only to a particular virtual host. For more information on Apache virtual host directives, refer to <https://httpd.apache.org/docs/2.4/en/mod/core.html#virtualhost>.

The ChangeHat-specific configuration keyword is `AADefaultHatName`. It is used similarly to `AAHatName`, for example, `AADefaultHatName My_Funky_Default_Hat`.

It allows you to specify a default hat to be used for virtual hosts and other Apache server directives, so that you can have different defaults for different virtual hosts. This can be overridden by the `AAHatName` directive and is checked for only if there is not a matching `AAHatName` or hat named by the URI. If the `AADefaultHatName` hat does not exist, it falls back to the `DEFAULT_URI` hat if it exists/

If none of those are matched, it goes back to the “parent” Apache hat.

38.1.2 Location and directory directives

Location and directory directives specify hat names in the program configuration file so the Apache calls the hat regarding its security. For Apache, you can find documentation about the location and directory directives at <https://httpd.apache.org/docs/2.4/en/sections.html>.

The location directive example below specifies that, for a given location, `mod_apparmor` should use a specific hat:

```
<Location /foo/>
  AAHatName MY_HAT_NAME
</Location>
```

This tries to use `MY_HAT_NAME` for any URI beginning with `/foo/` (`/foo/`, `/foo/bar`, `/foo/cgi/path/blah_blah/blah`, etc.).

The directory directive works similarly to the location directive, except it refers to a path in the file system as in the following example:

```
<Directory "/srv/www/www.example.org/docs">
  # Note lack of trailing slash
  AAHatName example.org
</Directory>
```

38.2 Managing ChangeHat-aware applications

In the previous section you learned about `mod_apparmor` and the way it helps you to secure a specific Web application. This section walks you through a real-life example of creating a hat for a Web application, and using AppArmor's `change_hat` feature to secure it. This chapter focuses on AppArmor's command-line tools, as YaST's AppArmor module has limited functionality.

38.2.1 With AppArmor's command line tools

For illustration purposes, let us choose the Web application called *Adminer* (<https://www.adminer.org/en/>). It is a full-featured SQL database management tool written in PHP, yet consisting of a single PHP file. For Adminer to work, you need to set up an Apache Web server, PHP and its Apache module, and one of the database drivers available for PHP—MariaDB in this example. You can install the required packages with

```
zypper in apache2 apache2-mod_apparmor apache2-mod_php5 php5 php5-mysql
```

To set up the Web environment for running Adminer, follow these steps:

PROCEDURE 38.1: SETTING UP A WEB SERVER ENVIRONMENT

1. Make sure `apparmor` and `php5` modules are enabled for Apache. To enable the modules in any case, use:

```
> a2enmod apparmor php5
```

and then restart Apache with

```
> sudo systemctl restart apache2
```

2. Make sure MariaDB is running. If unsure, restart it with

```
> sudo systemctl restart mariadb
```

3. Download Adminer from <https://www.adminer.org>, copy it to `/srv/www/htdocs/adminer/`, and rename it to `adminer.php`, so that its full path is `/srv/www/htdocs/adminer/adminer.php`.
4. Test Adminer in your Web browser by entering `http://localhost/adminer/adminer.php` in its URI address field. If you installed Adminer to a remote server, replace `localhost` with the real host name of the server.

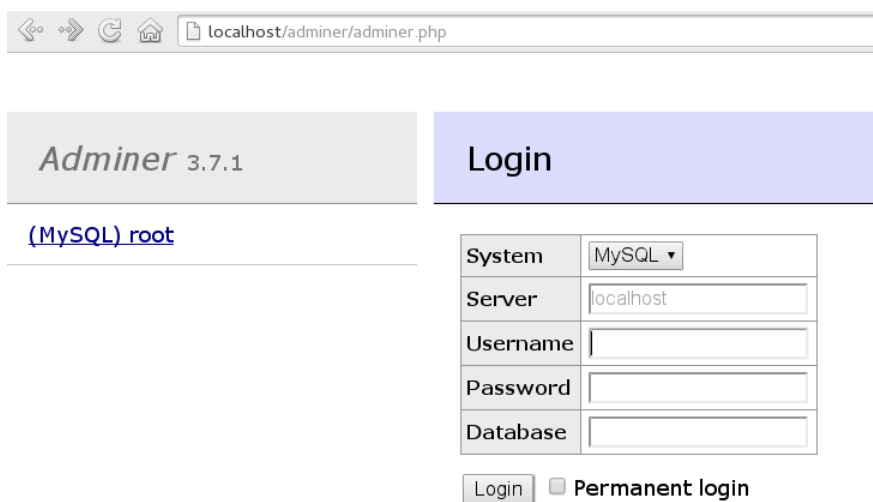

System	MySQL ▾
Server	localhost
Username	<input type="text"/>
Password	<input type="password"/>
Database	<input type="text"/>

Permanent login

FIGURE 38.1: ADMINER LOGIN PAGE



Tip

If you encounter problems viewing the Adminer login page, try to look for help in the Apache error log `/var/log/apache2/error.log`. Another reason you cannot access the Web page may be that your Apache is already under AppArmor control and its AppArmor profile is too tight to permit viewing Adminer. Check it with `aa-status`, and if needed, set Apache temporarily in complain mode with

```
# sudo aa-complain usr.sbin.httpd2-prefork
```

After the Web environment for Adminer is ready, you need to configure Apache's `mod_apparmor`, so that AppArmor can detect accesses to Adminer and change to the specific “hat”.

PROCEDURE 38.2: CONFIGURING mod_apparmor

1. Apache has several configuration files under `/etc/apache2/` and `/etc/apache2/conf.d/`. Choose your preferred one and open it in a text editor. In this example, the `vim` editor is used to create a new configuration file `/etc/apache2/conf.d/apparmor.conf`.

```
> sudo vim /etc/apache2/conf.d/apparmor.conf
```

2. Copy the following snippet into the edited file.

```
<Directory /srv/www/htdocs/adminer>
    AAHatName adminer
</Directory>
```

It tells Apache to let AppArmor know about a `change_hat` event when the Web user accesses the directory `/adminer` (and any file/directory inside) in Apache's document root. Remember, we placed the `adminer.php` application there.

3. Save the file, close the editor, and restart Apache with

```
> sudo systemctl restart apache2
```

Apache now knows about our Adminer and changing a “hat” for it. It is time to create the related hat for Adminer in the AppArmor configuration. If you do not have an AppArmor profile yet, create one before proceeding. Remember that if your Apache's main binary is `/usr/sbin/httpd2-prefork`, then the related profile is named `/etc/apparmor.d/usr.sbin.httpd2-prefork`.

PROCEDURE 38.3: CREATING A HAT FOR ADMINER

1. Open (or create one if it does not exist) the file `/etc/apparmor.d/usr.sbin.httpd2-prefork` in a text editor. Its contents should be similar to the following:

```
#include <tunables/global>

/usr/sbin/httpd2-prefork {
    #include <abstractions/apache2-common>
    #include <abstractions/base>
    #include <abstractions/php5>

    capability kill,
    capability setgid,
    capability setuid,

    /etc/apache2/** r,
```

```

/run/httpd.pid rw,
/usr/lib{,32,64}/apache2/** mr,
/var/log/apache2/** rw,

^DEFAULT_URI {
  #include <abstractions/apache2-common>
  /var/log/apache2/** rw,
}

^HANDLING_UNTRUSTED_INPUT {
  #include <abstractions/apache2-common>
  /var/log/apache2/** w,
}
}

```

2. Before the last closing curly bracket (`}`), insert the following section:

```

^adminer flags=(complain) {
}

```

Note the `(complain)` addition after the hat name—it tells AppArmor to leave the `adminer` hat in complain mode. That is because we need to learn the hat profile by accessing Adminer later on.

3. Save the file, and then restart AppArmor, then Apache.

```

> sudo systemctl reload apparmor apache2

```

4. Check if the `adminer` hat really is in complain mode.

```

> sudo aa-status
apparmor module is loaded.
39 profiles are loaded.
37 profiles are in enforce mode.
[...]
  /usr/sbin/httpd2-prefork
  /usr/sbin/httpd2-prefork//DEFAULT_URI
  /usr/sbin/httpd2-prefork//HANDLING_UNTRUSTED_INPUT
[...]
2 profiles are in complain mode.
  /usr/bin/getopt
  /usr/sbin/httpd2-prefork//adminer
[...]

```

As we can see, the `httpd2-prefork//adminer` is loaded in complain mode.

Our last task is to find out the right set of rules for the `adminer` hat. That is why we set the `adminer` hat into complain mode—the logging facility collects useful information about the access requirements of `adminer.php` as we use it via the Web browser. `aa-logprof` then helps us with creating the hat's profile.

PROCEDURE 38.4: GENERATING RULES FOR THE `adminer` HAT

1. Open Adminer in the Web browser. If you installed it locally, then the URI is `http://localhost/adminer/adminer.php`.
2. Choose the database engine you want to use (MariaDB in our case), and log in to Adminer using the existing database user name and password. You do not need to specify the database name as you can do so after logging in. Perform any operations with Adminer you like—create a new database, create a new table for it, set user privileges, and so on.
3. After the short testing of Adminer's user interface, switch back to console and examine the log for collected data.

```
> sudo aa-logprof
Reading log entries from /var/log/audit/audit.log.
Updating AppArmor profiles in /etc/apparmor.d.
Complain-mode changes:

Profile: /usr/sbin/httpd2-prefork^adminer
Path:    /dev/urandom
Mode:    r
Severity: 3

  1 - #include <abstractions/apache2-common>
[...]
 [8 - /dev/urandom]

[(A)llow] / (D)eny / (G)lob / Glob w/(E)xt / (N)ew / Abo(r)t / (F)inish / (O)pts
```

From the `aa-logprof` message, it is clear that our new `adminer` hat was correctly detected:

```
Profile: /usr/sbin/httpd2-prefork^adminer
```

The `aa-logprof` command asks you to pick the right rule for each discovered AppArmor event. Specify the one you want to use, and confirm with *Allow*. For more information on working with the `aa-genprof` and `aa-logprof` interface, see [Section 37.7.3.8, “aa-genprof—generating profiles”](#).



Tip

aa-logprof offers several valid rules for the examined event. Some are *abstractions*—predefined sets of rules affecting a specific common group of targets. Sometimes it is useful to include such an abstraction instead of a direct URI rule:

```
1 - #include <abstractions/php5>
[2 - /var/lib/php5/sess_3jdmii9cacj1e3jnahbtopajl7p064ai242]
```

In the example above, it is recommended hitting *1* and confirming with *A* to allow the abstraction.

4. After the last change, you are asked to save the changed profile.

```
The following local profiles were changed. Would you like to save them?
[1 - /usr/sbin/httpd2-prefork]

(S)ave Changes / [(V)iew Changes] / Abo(r)t
```

Hit *S* to save the changes.

5. Set the profile to enforce mode with **aa-enforce**

```
> sudo aa-enforce usr/sbin/httpd2-prefork
```

and check its status with **aa-status**

```
> sudo aa-status
apparmor module is loaded.
39 profiles are loaded.
38 profiles are in enforce mode.
[...]
  /usr/sbin/httpd2-prefork
  /usr/sbin/httpd2-prefork//DEFAULT_URI
  /usr/sbin/httpd2-prefork//HANDLING_UNTRUSTED_INPUT
  /usr/sbin/httpd2-prefork//adminer
[...]
```

As you can see, the `//adminer` hat jumped from *complain* to *enforce* mode.

6. Try to run Adminer in the Web browser, and if you encounter problems running it, switch it to the complain mode, repeat the steps that previously did not work well, and update the profile with **aa-logprof** until you are satisfied with the application's functionality.



Note: Hat and parent profile relationship

The profile `^adminer` is only available in the context of a process running under the parent profile `usr.sbin.httpd2-prefork`.

38.2.2 Adding hats and entries to hats in YaST

When you use the *Edit Profile* dialog (for instructions, refer to [Section 36.2, “Editing profiles”](#)) or when you add a new profile using *Manually Add Profile* (for instructions, refer to [Section 36.1, “Manually adding a profile”](#)), you are given the option of adding hats (subprofiles) to your AppArmor profiles. Add a `ChangeHat` subprofile from the *AppArmor Profile Dialog* window as in the following.

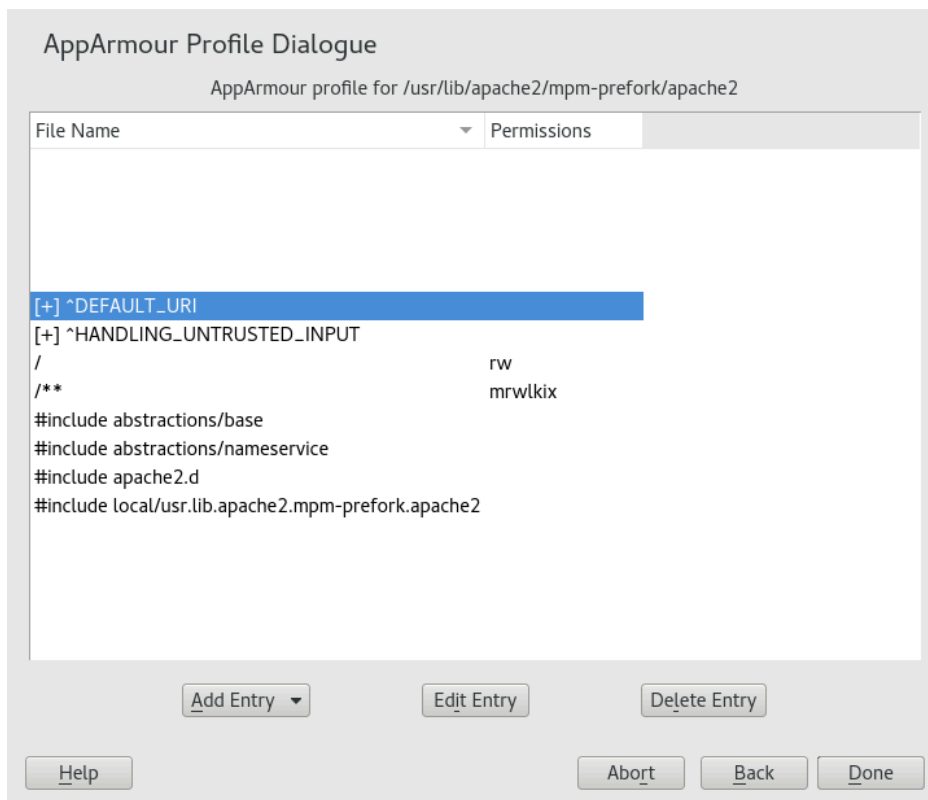

1. From the *AppArmor Profile Dialog* window, click *Add Entry* then select *Hat*. The *Enter Hat Name* dialog opens:

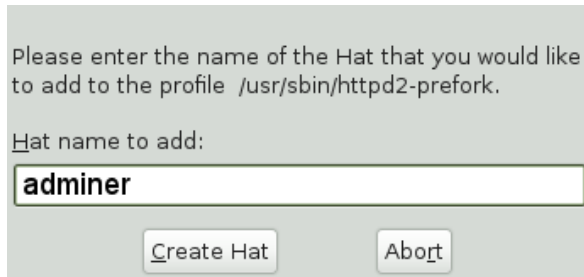

2. Enter the name of the hat to add to the AppArmor profile. The name is the URI that, when accessed, receives the permissions set in the hat.
3. Click *Create Hat*. You are returned to the *AppArmor Profile Dialog* screen.
4. After adding the new hat, click *Done*.

39 Confining users with pam_apparmor

An AppArmor profile applies to an executable program; if a portion of the program needs different access permissions than other portions need, the program can change hats via `change_hat` to a different role, also known as a subprofile. The `pam_apparmor` PAM module allows applications to confine authenticated users into subprofiles based on group names, user names, or a default profile. To accomplish this, `pam_apparmor` needs to be registered as a PAM session module.

The package `pam_apparmor` is not installed by default, you can install it using YaST or **zypper**. Details about how to set up and configure `pam_apparmor` can be found in `/usr/share/doc/packages/pam_apparmor/README` after the package has been installed. For details on PAM, refer to *Chapter 2, Authentication with PAM*.

40 Managing profiled applications

After creating profiles and immunizing your applications, SUSE® Linux Enterprise Server becomes more efficient and better protected if you perform AppArmor® profile maintenance (which involves analyzing log files, refining your profiles, backing up your set of profiles and keeping it up-to-date). You can deal with these issues before they become a problem by setting up event notification by e-mail, updating profiles from system log entries by running the `aa-logprof` tool, and dealing with maintenance issues.

40.1 Reacting to security event rejections

When you receive a security event rejection, examine the access violation and determine if that event indicated a threat or was part of normal application behavior. Application-specific knowledge is required to make the determination. If the rejected action is part of normal application behavior, run `aa-logprof` at the command line.

If the rejected action is not part of normal application behavior, this access should be considered a possible intrusion attempt (that was prevented) and this notification should be passed to the person responsible for security within your organization.

40.2 Maintaining your security profiles

In a production environment, you should plan on maintaining profiles for all the deployed applications. The security policies are an integral part of your deployment. You should plan on taking steps to back up and restore security policy files, plan for software changes, and allow any needed modification of security policies that your environment dictates.

40.2.1 Backing up your security profiles

Backing up profiles might save you from having to re-profile all your programs after a disk crash. Also, if profiles are changed, you can easily restore previous settings by using the backed up files. Back up profiles by copying the profile files to a specified directory.

1. You should first archive the files into one file. To do this, open a terminal window and enter the following as `root`:

```
> sudo tar zcLpf profiles.tgz /etc/apparmor.d
```

The simplest method to ensure that your security policy files are regularly backed up is to include the directory `/etc/apparmor.d` in the list of directories that your backup system archives.

2. You can also use `scp` or a file manager like Nautilus to store the files on certain kind of storage media, the network, or another computer.

40.2.2 Changing your security profiles

Maintenance of security profiles includes changing them if you decide that your system requires security for its applications. To change your profiles in AppArmor, refer to [Section 36.2, “Editing profiles”](#).

40.2.3 Introducing new software into your environment

When you add a new application version or patch to your system, you should always update the profile to fit your needs. You have several options, depending on your company's software deployment strategy. You can deploy your patches and upgrades into a test or production environment. The following explains how to do this with each method.

If you intend to deploy a patch or upgrade in a test environment, the best method for updating your profiles is to run `aa-logprof` in a terminal as `root`. For detailed instructions, refer to [Section 37.7.3.9, “aa-logprof—scanning the system log”](#).

If you intend to deploy a patch or upgrade directly into a production environment, the best method for updating your profiles is to monitor the system frequently to determine if any new rejections should be added to the profile and update as needed using `aa-logprof`. For detailed instructions, refer to [Section 37.7.3.9, “aa-logprof—scanning the system log”](#).

41 Support

This chapter outlines maintenance-related tasks. Learn how to update AppArmor® and get a list of available man pages providing basic help for using the command line tools provided by AppArmor. Use the troubleshooting section to learn about common problems encountered with AppArmor and their solutions. Report defects or enhancement requests for AppArmor following the instructions in this chapter.

41.1 Updating AppArmor online

Updates for AppArmor packages are provided in the same way as any other update for SUSE Linux Enterprise Server. Retrieve and apply them exactly like for any other package that ships as part of SUSE Linux Enterprise Server.

41.2 Using the man pages

There are man pages available for your use. In a terminal, enter `man apparmor` to open the AppArmor man page. Man pages are distributed in sections numbered 1 through 8. Each section is specific to a category of documentation:

TABLE 41.1: MAN PAGES: SECTIONS AND CATEGORIES

Section	Category
1	User commands
2	System calls
3	Library functions
4	Device driver information
5	Configuration file formats
6	Games
7	High level concepts

Section	Category
8	Administrator commands

The section numbers are used to distinguish man pages from each other. For example, exit(2) describes the exit system call, while exit(3) describes the exit C library function.

The AppArmor man pages are:

- aa-audit(8)
- aa-autodep(8)
- aa-complain(8)
- aa-decode(8)
- aa-disable(8)
- aa-easyprof(8)
- aa-enforce(8)
- aa-enxec(8)
- aa-genprof(8)
- aa-logprof(8)
- aa-notify(8)
- aa-status(8)
- aa-unconfined(8)
- aa_change_hat(8)
- logprof.conf(5)
- apparmor.d(5)
- apparmor.vim(5)
- apparmor(7)
- apparmor_parser(8)
- apparmor_status(8)

41.3 More information

Find more information about the AppArmor product at: <https://wiki.apparmor.net>. Find the product documentation for AppArmor in the installed system at `/usr/share/doc/manual`.

There is a mailing list for AppArmor that users can post to or join to communicate with developers. See <https://lists.ubuntu.com/mailman/listinfo/apparmor> for details.

41.4 Troubleshooting

This section lists the most common problems and error messages that may occur using AppArmor.

41.4.1 How to react to odd application behavior?

If you notice odd application behavior or any other type of application problem, you should first check the reject messages in the log files to see if AppArmor is too closely constricting your application. If you detect reject messages that indicate that your application or service is too closely restricted by AppArmor, update your profile to properly handle your use case of the application. Do this with `aa-logprof` (*Section 37.7.3.9, “aa-logprof—scanning the system log”*).

If you decide to run your application or service without AppArmor protection, remove the application's profile from `/etc/apparmor.d` or move it to another location.

41.4.2 My profiles do not work anymore ...

If you have been using previous versions of AppArmor and have updated your system (but kept your old set of profiles) you might notice applications which seemed to work perfectly before you updated behaving strangely, or not working.

This version of AppArmor introduces a set of new features to the profile syntax and the AppArmor tools that might cause trouble with older versions of the AppArmor profiles. Those features are:

- File Locking
- Network Access Control

- The `SYS_PTRACE` Capability
- Directory Path Access

The current version of AppArmor mediates file locking and introduces a new permission mode (`k`) for this. Applications requesting file locking permission might misbehave or fail altogether if confined by older profiles which do not explicitly contain permissions to lock files. If you suspect this being the case, check the log file under `/var/log/audit/audit.log` for entries like the following:

```
type=AVC msg=audit(1389862802.727:13939): apparmor="DENIED" \
operation="file_lock" parent=2692 profile="/usr/bin/opera" \
name="/home/tux/.qt/.qtrc.lock" pid=28730 comm="httpd2-prefork" \
requested_mask="::k" denied_mask="::k" fsuid=30 ouid=0
```

Update the profile using the `aa-logprof` command as outlined below.

The new network access control syntax based on the network family and type specification, described in [Section 34.5, "Network access control"](#), might cause application misbehavior or even stop applications from working. If you notice a network-related application behaving strangely, check the log file under `/var/log/audit/audit.log` for entries like the following:

```
type=AVC msg=audit(1389864332.233:13947): apparmor="DENIED" \
operation="socket_create" family="inet" parent=29985 profile="/bin/ping" \
sock_type="raw" pid=30251 comm="ping"
```

This log entry means that our example application, `/bin/ping` in this case, failed to get AppArmor's permission to open a network connection. This permission needs to be explicitly stated to make sure that an application has network access. To update the profile to the new syntax, use the `aa-logprof` command as outlined below.

The current kernel requires the `SYS_PTRACE` capability, if a process tries to access files in `/proc/PID/fd/*`. New profiles need an entry for the file and the capability, where old profiles only needed the file entry. For example:

```
/proc/*/fd/** rw,
```

in the old syntax would translate to the following rules in the new syntax:

```
capability SYS_PTRACE,
/proc/*/fd/** rw,
```

To update the profile to the new syntax, use the YaST Update Profile Wizard or the `aa-logprof` command as outlined below.

With this version of AppArmor, a few changes have been made to the profile rule syntax to better distinguish directory from file access. Therefore, certain rules matching both file and directory paths in the previous version might now match a path only. This could lead to AppArmor not being able to access a crucial directory, and thus trigger misbehavior of your application and various log messages. The following examples highlight the most important changes to the path syntax.

Using the old syntax, the following rule would allow access to files and directories in `/proc/net`. It would allow directory access only to read the entries in the directory, but not give access to files or directories under the directory, for example `/proc/net/dir/foo` would be matched by the asterisk (*), but as `foo` is a file or directory under `dir`, it cannot be accessed.

```
/proc/net/* r,
```

To get the same behavior using the new syntax, you need two rules instead of one. The first allows access to the file under `/proc/net` and the second allows access to directories under `/proc/net`. Directory access can only be used for listing the contents, not accessing files or directories underneath the directory.

```
/proc/net/* r,  
/proc/net/*/ r,
```

The following rule works similarly both under the old and the new syntax, and allows access to both files and directories under `/proc/net` (but does not allow a directory listing of `/proc/net/` itself):

```
/proc/net/** r,
```

To distinguish file access from directory access using the above expression in the new syntax, use the following two rules. The first one only allows to recursively access directories under `/proc/net` while the second one explicitly allows for recursive file access only.

```
/proc/net/**/ r,  
/proc/net/**[^/] r,
```

The following rule works similarly both under the old and the new syntax and allows access to both files and directories beginning with `foo` under `/proc/net`:

```
/proc/net/foo** r,
```

To distinguish file access from directory access in the new syntax and use the `**` globbing pattern, use the following two rules. The first one would have matched both files and directories in the old syntax, but only matches files in the new syntax because of the missing trailing slash. The second rule matched neither file nor directory in the old syntax, but matches directories only in the new syntax:

```
/proc/net/**foo r,  
/proc/net/**foo/ r,
```

The following rules illustrate how the use of the `?` globbing pattern has changed. In the old syntax, the first rule would have matched both files and directories (four characters, last character could be any but a slash). In the new syntax, it matches only files (trailing slash is missing). The second rule would match nothing in the old profile syntax, but matches directories only in the new syntax. The last rule matches explicitly matches a file called `bar` under `/proc/net/foo?`. Using the old syntax, this rule would have applied to both files and directories:

```
/proc/net/foo? r,  
/proc/net/foo?/ r,  
/proc/net/foo?/bar r,
```

To find and resolve issues related to syntax changes, take some time after the update to check the profiles you want to keep and proceed as follows for each application you kept the profile for:

1. Put the application's profile into complain mode:

```
> sudo aa-complain /path/to/application
```

Log entries are made for any actions violating the current profile, but the profile is not enforced and the application's behavior not restricted.

2. Run the application covering all the tasks you need this application to be able to perform.
3. Update the profile according to the log entries made while running the application:

```
> sudo aa-logprof /path/to/application
```

4. Put the resulting profile back into enforce mode:

```
> sudo aa-enforce /path/to/application
```

41.4.3 Resolving issues with Apache

After installing additional Apache modules (like `apache2-mod_apparmor`) or making configuration changes to Apache, profile Apache again to find out if additional rules need to be added to the profile. If you do not profile Apache again, it could be unable to start properly or be unable to serve Web pages.

41.4.4 How to exclude certain profiles from the list of profiles used?

Run `aa-disable PROGRAMNAME` to disable the profile for `PROGRAMNAME`. This command creates a symbolic link to the profile in `/etc/apparmor.d/disable/`. To reactivate the profile, delete the link, and run `systemctl reload apparmor`.

41.4.5 Can I manage profiles for applications not installed on my system?

Managing profiles with AppArmor requires you to have access to the log of the system on which the application is running. So you do not need to run the application on your profile build host if you have access to the machine that runs the application. You can run the application on one system, transfer the logs (`/var/log/audit.log` or, if `audit` is not installed, `journalctl | grep -i apparmor > path_to_logfile`) to your profile build host and run `aa-logprof -f PATH_TO_LOGFILE`.

41.4.6 How to spot and fix AppArmor syntax errors

Manually editing AppArmor profiles can introduce syntax errors. If you attempt to start or restart AppArmor with syntax errors in your profiles, error results are shown. This example shows the syntax of the entire parser error.

```
# systemctl start apparmor.service
```

```
Loading AppArmor profiles AppArmor parser error in /etc/apparmor.d/usr.sbin.squid \  
at line 410: syntax error, unexpected TOK_ID, expecting TOK_MODE  
Profile /etc/apparmor.d/usr.sbin.squid failed to load
```

Using the AppArmor YaST tools, a graphical error message indicates which profile contained the error and requests you to fix it.

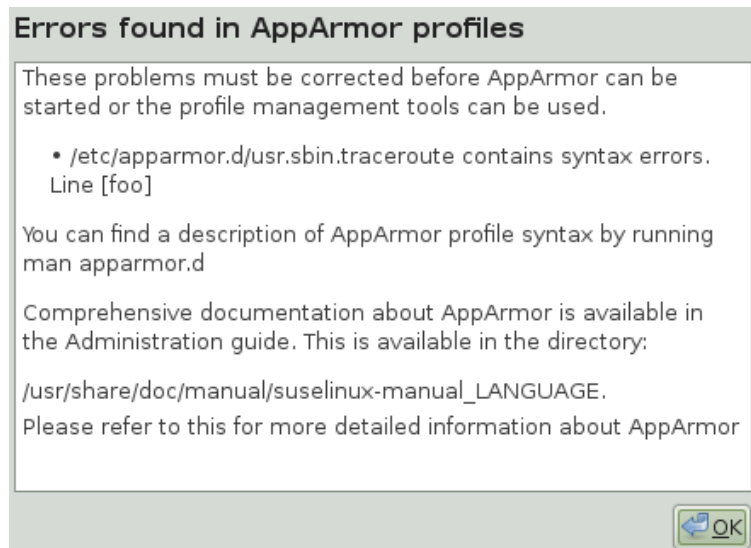

To fix a syntax error, log in to a terminal window as `root`, open the profile, and correct the syntax. Reload the profile set with `systemctl reload apparmor`.



Tip: AppArmor syntax highlighting in `vi`

The editor `vi` on SUSE Linux Enterprise Server supports syntax highlighting for AppArmor profiles. Lines containing syntax errors are displayed with a red background.

41.5 Reporting bugs for AppArmor

The developers of AppArmor are eager to deliver products of the highest quality. Your feedback and your bug reports help us keep the quality high. Whenever you encounter a bug in AppArmor, file a bug report against this product:

1. Use your Web browser to go to <https://bugzilla.suse.com/> and click *Log In*.
2. Enter the account data of your SUSE account and click *Login*. If you do not have a SUSE account, click *Create Account* and provide the required data.

3. If your problem has already been reported, check this bug report and add extra information to it, if necessary.
4. If your problem has not been reported yet, select *New* from the top navigation bar and proceed to the *Enter Bug* page.
5. Select the product against which to file the bug. In your case, this would be your product's release. Click *Submit*.
6. Select the product version, component (AppArmor in this case), hardware platform, and severity.
7. Enter a brief headline describing your problem and add a more elaborate description including log files. You may create attachments to your bug report for screenshots, log files, or test cases.
8. Click *Submit* after you have entered all the details to send your report to the developers.

42 AppArmor glossary

Abstraction

See *profile foundation classes* below.

Apache

Apache is a freely available Unix-based Web server. It is currently the most commonly used Web server on the Internet. Find more information about Apache at the Apache Web site at <https://www.apache.org>.

application fire-walling

AppArmor confines applications and limits the actions they are permitted to take. It uses privilege confinement to prevent attackers from using malicious programs on the protected server and even using trusted applications in unintended ways.

attack signature

Pattern in system or network activity that alerts of a possible virus or hacker attack. Intrusion detection systems might use attack signatures to distinguish between legitimate and potentially malicious activity.

By not relying on attack signatures, AppArmor provides "proactive" instead of "reactive" defense from attacks. This is better because there is no window of vulnerability where the attack signature must be defined for AppArmor as it does for products using attack signatures.

GUI

Graphical user interface. Refers to a software front-end meant to provide an attractive and easy-to-use interface between a computer user and application. Its elements include windows, icons, buttons, cursors and scrollbars.

globbing

File name substitution. Instead of specifying explicit file name paths, you can use helper characters `*` (substitutes any number of characters except special ones such as `/` or `?`) and `?` (substitutes exactly one character) to address multiple files/directories at once. `**` is a special substitution that matches any file or directory below the current directory.

HIP

Host intrusion prevention. Works with the operating system kernel to block abnormal application behavior in the expectation that the abnormal behavior represents an unknown attack. Blocks malicious packets on the host at the network level before they can “hurt” the application they target.

mandatory access control

A means of restricting access to objects that is based on fixed security attributes assigned to users, files and other objects. The controls are mandatory in the sense that they cannot be modified by users or their programs.

profile

AppArmor profile completely defines what system resources an individual application can access, and with what privileges.

profile foundation classes

Profile building blocks needed for common application activities, such as DNS lookup and user authentication.

RPM

The RPM Package Manager. An open packaging system available for anyone to use. It works on Red Hat Linux, SUSE Linux Enterprise Server, and other Linux and Unix systems. It is capable of installing, uninstalling, verifying, querying and updating computer software packages. See <https://rpm.org/> for more information.

SSH

Secure Shell. A service that allows you to access your server from a remote computer and issue text commands through a secure connection.

streamlined access control

AppArmor provides streamlined access control for network services by specifying which files each program is allowed to read, write and execute. This ensures that each program does what it is supposed to do and nothing else.

URI

Universal resource identifier. The generic term for all types of names and addresses that refer to objects on the World Wide Web. A URL is one kind of URI.

URL

Uniform Resource Locator. The global address of documents and other resources on the Web.

The first part of the address indicates what protocol to use and the second part specifies the IP address or the domain name where the resource is located.

For example, when you visit <http://www.suse.com>, you are using the HTTP protocol, as the beginning of the URL indicates.

vulnerabilities

An aspect of a system or network that leaves it open to attack. Characteristics of computer systems that allow an individual to keep it from correctly operating or that allows unauthorized users to take control of the system. Design, administrative or implementation weaknesses or flaws in hardware, firmware or software. If exploited, a vulnerability could lead to an unacceptable impact in the form of unauthorized access to information or the disruption of critical processing.

VI SELinux

43 Configuring SELinux **431**

43 Configuring SELinux

In this chapter, you learn how to set up and manage SELinux on SUSE Linux Enterprise Server. The following topics are covered:

- Why Use SELinux?
- Understanding SELinux
- Setting Up SELinux
- Managing SELinux

43.1 Why use SELinux?

SELinux was developed as an additional Linux security solution that uses the security framework in the Linux kernel. The purpose was to allow for a more granular security policy that goes beyond the standard Discretionary Access Controls (DAC), the traditional file permissions of owner/group/world, and read/write/execute.

An example explains why a solution such as SELinux (or its counterpart AppArmor) is needed:

“One morning, I found out that my server was hacked. The server was running a fully patched SUSE Linux Enterprise Server installation. A firewall was configured on it and no unnecessary services were offered by this server. Further analysis revealed that the hacker had come in through a vulnerable PHP script that was a part of one of the Apache virtual hosts that were running on this server. The intruder had managed to get access to a shell, using the `wwwrun` account that was used by the Apache Web server. As this `wwwrun` user, the intruder had created several scripts in the `/var/tmp` and the `/tmp` directories, which were a part of a botnet that was launching a Distributed Denial of Service attack against several servers.”

The interesting thing about this hack is that it occurred on a server where nothing was really wrong. All file permissions were set correctly, but the intruder still managed to get into the system. This example demonstrates that in certain cases, additional security is needed.

SELinux uses labels attached to objects (for example, files and network sockets) and uses them for access control decision.

43.1.1 Support status

The SELinux framework is supported on SUSE Linux Enterprise Server 15 SP6. SLES offers all binaries and libraries you need to use SELinux on your server.

A policy is not included, and you must build your own. Third-party policies are not supported. See [Section 43.3, “Installing SELinux packages”](#) and [Section 43.4, “Installing an SELinux policy”](#) for information on installing an openSUSE policy for testing.

43.1.2 Understanding SELinux components

Before starting the configuration of SELinux, you should know a bit about how SELinux is organized. Three components play a role:

- The security framework in the Linux kernel
- The SELinux libraries and binaries
- The SELinux policy

The default kernel of SUSE Linux Enterprise Server supports SELinux and the tools that are needed to manage it. The most important part of the work of the administrator with regard to SELinux is managing the policy.

In the SELinux policy, security labels are applied to different objects on a Linux server. These objects typically are users, ports, processes and files. Using these security labels, rules are created that define what is and what is not allowed on a server. By default, SELinux denies everything, and by creating the appropriate rules you can allow the access that is strictly necessary. Rules should therefore exist for all programs that you want to use on a system.

Alternatively, you could configure parts of a system to run in unconfined mode, which means that specific ports, programs, users, files and directories are not protected by SELinux. This mode is useful if you want to use SELinux to protect some essential services. This leaves your system incompletely protected, and it is better to apply SELinux to the whole system.

To ensure the appropriate protection of your system, you need an SELinux policy. This must be a tailor-made policy in which all files are provided with a label, and all services and users have a security label as well to express which files and directories can be accessed by which user and processes on the server. Developing such a policy is a tremendous amount of work.

A freely available SELinux policy might work on your server, but it may not offer the same protection as a custom policy. SUSE does not support third-party policies.

43.2 SELinux policy overview

The policy is the key component in SELinux. Your SELinux policy defines rules that specify which objects can access which files, directories, ports and processes on a system. To do this, a security context is defined for these. On an SELinux system where the policy has been applied to label the file system, you can use the `ls -Z` command on any directory to find the security context for the files in that directory. *Example 43.1: "Security context settings using `ls -Z`"* shows the security context settings for the directories in the `/` directory of a SUSE Linux Enterprise Server system with an SELinux-labeled file system.

EXAMPLE 43.1: SECURITY CONTEXT SETTINGS USING `ls -Z`

```
> ls -Z /
system_u:object_r:bin_t bin
system_u:object_r:boot_t boot
system_u:object_r:device_t dev
system_u:object_r:etc_t etc
system_u:object_r:home_root_t home
system_u:object_r:lib_t lib
system_u:object_r:lib_t lib64
system_u:object_r:lost_found_t lost+found
system_u:object_r:mnt_t media
system_u:object_r:mnt_t mnt
system_u:object_r:usr_t opt
system_u:object_r:proc_t proc
system_u:object_r:default_t root
system_u:object_r:bin_t/sbin
system_u:object_r:security_t selinux
system_u:object_r:var_t srv
system_u:object_r:sysfs_t sys
system_u:object_r:tmp_t tmp
system_u:object_r:usr_t usr
system_u:object_r:var_t var
```

The most important line in the security context is the context type. This is the part of the security context that often ends in `_t`. It tells SELinux which kind of access the object is allowed. In the policy, rules are specified to define which type of user or which type of role has access to which type of context. For example, this can happen by using a rule like the following:

```
allow user_t bin_t:file {read execute getattr};
```

This example rule states that the user who has the context type `user_t` (this user is called the source object) is allowed to access objects of class "file" with the context type `bin_t` (the target), using the permissions `read`, `execute`, and `getattr`.

An SELinux policy contains a vast number of rules. To make it more manageable, policies are often split into modules. This allows administrator to switch protection on or off for different parts of the system.

When compiling the policy for your system, you have a choice to either work with a modular policy, or a monolithic policy, where one vast policy is used to protect everything on your system. It is strongly recommended to use a modular policy and not a monolithic policy. Modular policies are much easier to manage.

43.3 Installing SELinux packages

From the command line, install the following packages:

```
> sudo zypper in restorecond policycoreutils setools-console
```

This does not install a policy. See [Section 43.4, "Installing an SELinux policy"](#) for information on installing an openSUSE policy for testing.

43.4 Installing an SELinux policy

The policy is an essential component of SELinux. SUSE Linux Enterprise Server 15 SP6 does *not* include a default policy, and you must build a policy that is customized for your installation. SELinux policies should be customized for your particular needs. Contact SUSE consulting services for assistance. We recommend [slemicro](#) for customers and partners who are looking for a containerized or virtualized host with full SELinux support, including a supported policy.

For *testing* purposes you can obtain policies from https://download.opensuse.org/repositories/security:/SELinux_legacy/. This provides repositories for SUSE Linux Enterprise Server with several additional packages, including policies.

1. Copy the repository link that matches your SUSE Linux Enterprise Server version, and add it with Zypper:

```
> sudo zypper ar -f \  
https://download.opensuse.org/repositories/security:/SELinux/15.6/ \  
SELinux-Legacy
```

2. Install the following packages:

```
> sudo zypper in selinux-policy-targeted selinux-policy-devel
```

43.5 Putting SELinux into permissive mode

In permissive mode, SELinux does not protect your system but it still logs everything that happens. Use this mode for testing and configuring your system.

In `/etc/selinux/config`, SELinux is set to permissive mode by default.

To enable the use of SELinux for your system, modify the GRUB 2 boot loader. In `/etc/default/grub`, search for the line `GRUB_CMDLINE_LINUX_DEFAULT=`. Add the following two parameters:

```
lsm=selinux,bpf selinux=1
```

The first parameter tells the kernel to use SELinux and not AppArmor. The second parameter enables SELinux. After adding the parameters, rebuild your GRUB 2 configuration with the following command:

```
grub2-mkconfig -o /boot/grub2/grub.cfg
```

Now you can reboot. At this point you have a functional SELinux system, and it is time to further configure it. In the current status, SELinux does not limit any activities and logs everything that it should be doing if it were in enforcing mode. Review the log files to learn what activities are not allowed.

43.6 Putting SELinux into enforcing mode

When systems run SELinux in permissive mode, users and processes might label various file system objects incorrectly. This can cause problems when switching to enforcing mode because SELinux relies on correct labels of file system objects.

Before switching into enforcing mode, make sure to first reset the security context (extended attributes):

```
> sudo restorecon -R /
```

Now you can put SELinux into enforcing mode. For this, edit `/etc/selinux/config` and set `SELINUX=enforcing`.

Reboot your server and see if it still comes up the way you expect it to and if you can still log in. After logging in, run the `sestatus -v` command. It should give you an output similar to [Example 43.2: "Verifying that SELinux is functional"](#).

EXAMPLE 43.2: VERIFYING THAT SELINUX IS FUNCTIONAL

```
> sudo sestatus -v
SELinux status:                enabled
SELinuxfs mount:              /sys/fs/selinux
SELinux root directory:      /etc/selinux
Loaded policy name:          targeted
Current mode:                 enforcing
Mode from config file:       enforcing
Policy MLS status:           enabled
Policy deny_unknown status:  allowed
Memory protection checking:   requested(insecure)
Max kernel policy version:    33

Process contexts:
Current context:              unconfined_u:unconfined_r:unconfined_t:s0-s0:c0.c1023
Init context:                 system_u:system_r:init_t:s0
/usr/sbin/sshd                system_u:system_r:sshd_t:s0-s0:c0.c1023

File contexts:
Controlling terminal:        unconfined_u:object_r:user_tty_device_t:s0
/etc/passwd                  system_u:object_r:passwd_file_t:s0
/etc/shadow                  system_u:object_r:shadow_t:s0
/bin/bash                    system_u:object_r:shell_exec_t:s0 \
-> system_u:object_r:shell_exec_t:s0
/bin/login                   system_u:object_r:login_exec_t:s0
/bin/sh                      system_u:object_r:bin_t:s0 \
-> system_u:object_r:shell_exec_t:s0
/sbin/agetty                 system_u:object_r:bin_t:s0 \
-> system_u:object_r:getty_exec_t:s0
/sbin/init                   system_u:object_r:bin_t:s0 -> \
system_u:object_r:init_exec_t:s0
/usr/sbin/sshd               system_u:object_r:sshd_exec_t:s0
```

If you are not able to boot the server properly with SELinux in enforcing mode, switch back to permissive mode. Check the log files with `less /var/log/audit/audit.log`. For more details, see [Section 43.9, “Troubleshooting”](#).

43.7 Configuring SELinux

Before you start tuning your server, verify the SELinux installation. You have already used the command `sestatus -v` to view the current mode, process and file contexts. Next, run

```
> sudo semanage boolean -l
```

which lists all Boolean switches that are available, and at the same time verifies that you can access the policy. *Example 43.3, “Getting a list of booleans and verifying policy access”* shows part of the output of this command.

EXAMPLE 43.3: GETTING A LIST OF BOOLEANS AND VERIFYING POLICY ACCESS

```
> sudo semanage boolean -l
SELinux boolean          Description
ftp_home_dir             -> off  ftp_home_dir
mozilla_read_content     -> off  mozilla_read_content
spamassassin_can_network -> off  spamassassin_can_network
httpd_can_network_relay  -> off  httpd_can_network_relay
openvpn_enable_homedirs  -> off  openvpn_enable_homedirs
gpg_agent_env_file       -> off  gpg_agent_env_file
allow_httpd_awstats_script_anon_write -> off  allow_httpd_awstats_script_anon_write
httpd_can_network_connect_db -> off  httpd_can_network_connect_db
allow_ftp_full_access    -> off  allow_ftp_full_access
samba_domain_controller -> off  samba_domain_controller
httpd_enable_cgi         -> off  httpd_enable_cgi
virt_use_nfs             -> off  virt_use_nfs
```

Another command that outputs useful information at this stage is

```
> sudo semanage fcontext -l
```

It shows the default file context settings as provided by the policy (see *Example 43.4: “Getting file context information”* for partial output of this command).

EXAMPLE 43.4: GETTING FILE CONTEXT INFORMATION

```
> sudo semanage fcontext -l
/var/run/usb(/.*)?      all files
system_u:object_r:hotplug_var_run_t
/var/run/utmp           regular file
system_u:object_r:initrc_var_run_t
/var/run/vbe.*         regular file
system_u:object_r:hald_var_run_t
/var/run/vmnat.*       socket
system_u:object_r:vmware_var_run_t
/var/run/vmware.*      all files
system_u:object_r:vmware_var_run_t
/var/run/watchdog\.pid regular file
system_u:object_r:watchdog_var_run_t
/var/run/winbindd(/.*)? all files
system_u:object_r:winbind_var_run_t
```

```

/var/run/wnn-unix(/.*)          all files
system_u:object_r:canna_var_run_t
/var/run/wpa_supplicant(/.*)?  all files
system_u:object_r:NetworkManager_var_run_t
/var/run/wpa_supplicant-global socket
system_u:object_r:NetworkManager_var_run_t
/var/run/xdmctl(/.*)?         all files
system_u:object_r:xdm_var_run_t
/var/run/yiff-[0-9]+\ .pid     regular file
system_u:object_r:soundd_var_run_t

```

43.8 Managing SELinux

The base SELinux configuration is now operational and it can now be configured to secure your server. In SELinux, an additional set of rules is used to define exactly which process or user can access which files, directories, or ports. To do this, SELinux applies a context to every file, directory, process and port. This context is a security label that defines how this file, directory, process or port should be treated. These context labels are used by the SELinux policy, which defines exactly what should be done with the context labels. By default, the policy blocks all non-default access, which means that, as an administrator, you need to enable all features that are non-default on your server.

43.8.1 Viewing the security context

As already mentioned, files, directories and ports can be labeled. Within each label, different contexts are used. To be able to perform your daily administration work, the type context is what you are most interested in. As an administrator, you work with the type context. Many commands allow you to use the `-Z` option to list current context settings. In *Example 43.5: “The default context for directories in the root directory”* you can see what the context settings are for the directories in the root directory.

EXAMPLE 43.5: THE DEFAULT CONTEXT FOR DIRECTORIES IN THE ROOT DIRECTORY

```

> sudo ls -Z
dr-xr-xr-x. root root system_u:object_r:bin_t:s0      bin
dr-xr-xr-x. root root system_u:object_r:boot_t:s0     boot
drwxr-xr-x. root root system_u:object_r:cgroup_t:s0   cgroup
drwxr-xr-x+ root root unconfined_u:object_r:default_t:s0 data
drwxr-xr-x. root root system_u:object_r:device_t:s0   dev

```



```

drwxr-xr-x. root root system_u:object_r:etc_t:s0      etc
drwxr-xr-x. root root system_u:object_r:home_root_t:s0 home
dr-xr-xr-x. root root system_u:object_r:lib_t:s0      lib
dr-xr-xr-x. root root system_u:object_r:lib_t:s0      lib64
drwx-----. root root system_u:object_r:lost_found_t:s0 lost+found
drwxr-xr-x. root root system_u:object_r:mnt_t:s0       media
drwxr-xr-x. root root system_u:object_r:autofs_t:s0    misc
drwxr-xr-x. root root system_u:object_r:mnt_t:s0       mnt
drwxr-xr-x. root root unconfined_u:object_r:default_t:s0 mnt2
drwxr-xr-x. root root unconfined_u:object_r:default_t:s0 mounts
drwxr-xr-x. root root system_u:object_r:autofs_t:s0    net
drwxr-xr-x. root root system_u:object_r:usr_t:s0       opt
dr-xr-xr-x. root root system_u:object_r:proc_t:s0      proc
drwxr-xr-x. root root unconfined_u:object_r:default_t:s0 repo
dr-xr-x---. root root system_u:object_r:admin_home_t:s0 root
dr-xr-xr-x. root root system_u:object_r:bin_t:s0       sbin
drwxr-xr-x. root root system_u:object_r:security_t:s0  selinux
drwxr-xr-x. root root system_u:object_r:var_t:s0       srv
-rw-r--r--. root root unconfined_u:object_r:swapfile_t:s0 swapfile
drwxr-xr-x. root root system_u:object_r:sysfs_t:s0     sys
drwxrwxrwt. root root system_u:object_r:tmp_t:s0      tmp
-rw-r--r--. root root unconfined_u:object_r:etc_runtime_t:s0 tmp2.tar
-rw-r--r--. root root unconfined_u:object_r:etc_runtime_t:s0 tmp.tar
drwxr-xr-x. root root system_u:object_r:usr_t:s0       usr
drwxr-xr-x. root root system_u:object_r:var_t:s0       var

```

In the listing above, you can see the complete context for all directories. It consists of a user, a role, and a type. The s0 setting indicates the security level in Multi Level Security environments. These environments are not discussed here. In such an environment, make sure that s0 is set. The Context Type defines what kind of activity is permitted in the directory. Compare, for example, the `/root` directory, which has the `admin_home_t` context type, and the `/home` directory, which has the `home_root_t` context type. In the SELinux policy, different kinds of access are defined for these context types.

Security labels are not only associated with files, but also with other items, such as ports and processes. In [Example 43.6: “Showing SELinux settings for processes with ps Zaux”](#) for example you can see the context settings for processes on your server.

EXAMPLE 43.6: SHOWING SELINUX SETTINGS FOR PROCESSES WITH ps Zaux

```

> sudo ps Zaux
LABEL                                USER      PID %CPU %MEM    VSZ   RSS TTY      STAT START
   TIME COMMAND
system_u:system_r:init_t             root      1  0.0  0.0  10640  808 ?        Ss   05:31
   0:00 init [5]

```

system_u:system_r:kernel_t	root	2	0.0	0.0	0	0	?	S	05:31
0:00 [kthreadd]									
system_u:system_r:kernel_t	root	3	0.0	0.0	0	0	?	S	05:31
0:00 [ksoftirqd/0]									
system_u:system_r:kernel_t	root	6	0.0	0.0	0	0	?	S	05:31
0:00 [migration/0]									
system_u:system_r:kernel_t	root	7	0.0	0.0	0	0	?	S	05:31
0:00 [watchdog/0]									
system_u:system_r:sysadm_t	root	2344	0.0	0.0	27640	852	?	Ss	05:32
0:00 /usr/sbin/mcelog --daemon --config-file /etc/mcelog/mcelog.conf									
system_u:system_r:sshd_t	root	3245	0.0	0.0	69300	1492	?	Ss	05:32
0:00 /usr/sbin/sshd -o PidFile=/var/run/sshd.init.pid									
system_u:system_r:cupsd_t	root	3265	0.0	0.0	68176	2852	?	Ss	05:32
0:00 /usr/sbin/cupsd									
system_u:system_r:nscd_t	root	3267	0.0	0.0	772876	1380	?	Ssl	05:32
0:00 /usr/sbin/nscd									
system_u:system_r:postfix_master_t	root	3334	0.0	0.0	38320	2424	?	Ss	05:32
0:00 /usr/lib/postfix/master									
system_u:system_r:postfix_qmgr_t	postfix	3358	0.0	0.0	40216	2252	?	S	05:32
0:00 qmgr -l -t fifo -u									
system_u:system_r:crond_t	root	3415	0.0	0.0	14900	800	?	Ss	05:32
0:00 /usr/sbin/cron									
system_u:system_r:fsdaemon_t	root	3437	0.0	0.0	16468	1040	?	S	05:32
0:00 /usr/sbin/smartd									
system_u:system_r:sysadm_t	root	3441	0.0	0.0	66916	2152	?	Ss	05:32
0:00 login -- root									
system_u:system_r:sysadm_t	root	3442	0.0	0.0	4596	800	tty2	Ss+	05:32
0:00 /sbin/mingetty tty2									

43.8.2 Selecting the SELinux mode

In SELinux, three different modes can be used:

Enforcing:

This is the default mode. SELinux protects your server according to the rules in the policy, and SELinux logs all its activity to the audit log.

Permissive:

This mode is useful for troubleshooting. If set to Permissive, SELinux does not protect your server, but it still logs everything that happens to the log files.

Disabled:

In this mode, SELinux is switched off and no logging occurs. The file system labels are not removed from the file system.

You have already read how you can set the current SELinux mode from GRUB 2 while booting using the enforcing boot parameter.

43.8.3 Modifying SELinux context types

An important part of the work of an administrator is setting context types on files to ensure appropriate working of SELinux.

If a file is created within a specific directory, it inherits the context type of the parent directory by default. If a file is moved from one location to another location, it retains the context type that it had in the old location.

To set the context type for files, you can use the `semanage fcontext` command. With this command, you write the new context type to the policy, but it does not change the actual context type immediately. To apply the context types that are in the policy, you need to run the `restorecon` command afterward.

The challenge when working with `semanage fcontext` is to find out which context you need. You can use

```
> sudo semanage fcontext -l
```

to list all contexts in the policy, but it may be a bit hard to find out the actual context you need from that list as it is rather long (see [Example 43.7: "Viewing default file contexts"](#)).

EXAMPLE 43.7: VIEWING DEFAULT FILE CONTEXTS

```
> sudo semanage fcontext -l | less
SELinux fcontext                                     type                Context
/                                                     directory
 system_u:object_r:root_t:s0
/.*                                                  all files
 system_u:object_r:default_t:s0
/[^/]+                                             regular file
 system_u:object_r:etc_runtime_t:s0
/\.autofsck                                        regular file
 system_u:object_r:etc_runtime_t:s0
/\.autorelabel                                    regular file
 system_u:object_r:etc_runtime_t:s0
/\.journal                                         all files           X:>>None>>
/\.suspended                                       regular file
 system_u:object_r:etc_runtime_t:s0
/a?quota\.(user|group)                             regular file
 system_u:object_r:quota_db_t:s0
```

```
/afs                                directory
system_u:object_r:mnt_t:s0
/bin                                directory
system_u:object_r:bin_t:s0
/bin/.*                             all files
system_u:object_r:bin_t:s0
```

There are three ways to find out which context settings are available for your services:

- Install the service and look at the default context settings that are used. This is the easiest and recommended option.
- Consult the man page for the specific service. Some services have a man page that ends in `_selinux`, which contains all the information you need to find the correct context settings. When you have found the right context setting, apply it using `semanage fcontext`. This command takes `-t` context type as its first argument, followed by the name of the directory or file to which you want to apply the context settings. To apply the context to everything that already exists in the directory where you want to apply the context, you add the regular expression `(/.*)?` to the name of the directory. This means: optionally, match a slash followed by any character. The examples section of the `semanage` man page has some useful usage examples for `semanage`. For more information on regular expressions, see for example the tutorial at <https://www.regular-expressions.info/>.
- Display a list of all context types that are available on your system:

```
> sudo seinfo -t
```

Since the command by itself outputs an overwhelming amount of information, it should be used in combination with `grep` or a similar command for filtering.

43.8.4 Applying file contexts

To help you apply the SELinux context properly, the following procedure shows how to set a context using `semanage fcontext` and `restorecon`. You notice that at first attempt, the Web server with a non-default document root does not work. After changing the SELinux context, it does:

1. Create the `/web` directory and then change to it:

```
> sudo mkdir /web && cd /web
```

2. Use a text editor to create the file `/web/index.html` that contains the text welcome to my Web site.

3. Open the file `/etc/apache2/default-server.conf` with an editor, and change the `DocumentRoot` line to `DocumentRoot /web`

4. Start the Apache Web server:

```
> sudo systemctl start apache2
```

5. Open a session to your local Web server:

```
> w3m localhost
```

You receive a *Connection refused* message. Press `Enter`, and then `q` to quit w3m.

6. Find the current context type for the default Apache `DocumentRoot`, which is `/srv/www/htdocs`. It should be set to `httpd_sys_content_t`:

```
> sudo ls -Z /srv/www
```

7. Set the new context in the policy and press `Enter`:

```
> sudo semanage fcontext -a -f "" -t httpd_sys_content_t '/web(/.*) ?'
```

8. Apply the new context type:

```
> sudo restorecon /web
```

9. Show the context of the files in the directory `/web`. You can see that the new context type has been set properly to the `/web` directory, but not to its contents.

```
> sudo ls -Z /web
```

10. Apply the new context recursively to the `/web` directory. The type context has now been set correctly.

```
> sudo restorecon -R /web
```

11. Restart the Web server:

```
> sudo systemctl restart apache2
```

You should now be able to access the contents of the `/web` directory.

43.8.5 Configuring SELinux policies

The easiest way to change the behavior of the policy is by working with Booleans. These are on-off switches that you can use to change the settings in the policy. To find out which Booleans are available, run

```
> sudo semanage boolean -l
```

It shows a long list of Booleans, with a short description of what each of these Booleans does for you. When you have found the Boolean you want to set, you can use `setsebool -P`, followed by the name of the Boolean that you want to change. It is important to use the `-P` option at all times when using `setsebool`. This option writes the setting to the policy file on disk, and this is the only way to make sure that the Boolean is applied automatically after a reboot.

The procedure below gives an example of changing Boolean settings

1. List Booleans that are related to FTP servers.

```
> sudo semanage boolean -l | grep ftp
```

2. Turn the Boolean off:

```
> sudo setsebool allow_ftp_anon_write off
```

It does not take much time to write the change. Then verify that the Boolean is indeed turned off:

```
> sudo semanage boolean -l|grep ftpd_anon
```

3. Reboot your server.
4. Check again to see if the `allow_ftp_anon_write` Boolean is still turned on. As it has not yet been written to the policy, you notice that it is off.
5. Switch the Boolean and write the setting to the policy:

```
> sudo setsebool -P allow_ftp_anon_write
```

43.8.6 Working with SELinux modules

By default, SELinux uses a modular policy. This means that the policy that implements SELinux features is not just one huge policy, but it consists of many smaller modules. Each module covers a specific part of the SELinux configuration. The concept of the SELinux module was introduced to make it easier for third party vendors to make their services compatible with SELinux. To get an overview of the SELinux modules, you can use the `semodule -l` command. This command lists all current modules in use by SELinux and their version numbers.

As an administrator, you can switch modules on or off. This can be useful to disable only a part of SELinux and not everything to run a specific service without SELinux protection. Especially in the case of SUSE Linux Enterprise Server, where there is not a completely supported SELinux policy yet, it can make sense to switch off all modules that you do not need so that you can focus on the services that really do need SELinux protection. To switch off an SELinux module, use

```
> sudo semodule -d MODULENAME
```

To switch it on again, you can use

```
> sudo semodule -e modulename
```

43.9 Troubleshooting

By default, if SELinux is the reason something is not working, a log message to this effect is sent to the `/var/log/audit/audit.log` file. That is, if the `auditd` service is running. If you see an empty `/var/log/audit`, start the `auditd` service using

```
> sudo systemctl start auditd
```

and enable it in the targets of your system, using

```
> sudo systemctl enable auditd
```

You can see a partial example of the contents of `/var/log/audit/audit.log` below:

EXAMPLE 43.8: EXAMPLE LINES FROM `/var/log/audit/audit.log`

```
type=DAEMON_START msg=audit(1348173810.874:6248): auditd start, ver=1.7.7 format=raw
kernel=6.4.0-150600.9-default auid=0 pid=4235 subj=system_u:system_r:auditd_t
res=success
```

```

type=AVC msg=audit(1348173901.081:292): avc: denied { write } for
  pid=3426 comm="smartd" name="smartmontools" dev=sda6 ino=581743
  scontext=system_u:system_r:fsdaemon_t tcontext=system_u:object_r:var_lib_t tclass=dir
type=AVC msg=audit(1348173901.081:293): avc: denied { remove_name } for pid=3426
  comm="smartd" name="smartd.WDC_WD2500BEKT_75PVMT0-WD_WXC1A21E0454.ata.state~" dev=sda6
  ino=582390 scontext=system_u:system_r:fsdaemon_t tcontext=system_u:object_r:var_lib_t
  tclass=dir
type=AVC msg=audit(1348173901.081:294): avc: denied { unlink } for pid=3426
  comm="smartd" name="smartd.WDC_WD2500BEKT_75PVMT0-WD_WXC1A21E0454.ata.state~" dev=sda6
  ino=582390 scontext=system_u:system_r:fsdaemon_t tcontext=system_u:object_r:var_lib_t
  tclass=file
type=AVC msg=audit(1348173901.081:295): avc: denied { rename } for pid=3426
  comm="smartd" name="smartd.WDC_WD2500BEKT_75PVMT0-WD_WXC1A21E0454.ata.state" dev=sda6
  ino=582373 scontext=system_u:system_r:fsdaemon_t tcontext=system_u:object_r:var_lib_t
  tclass=file
type=AVC msg=audit(1348173901.081:296): avc: denied { add_name } for pid=3426
  comm="smartd" name="smartd.WDC_WD2500BEKT_75PVMT0-WD_WXC1A21E0454.ata.state~"
  scontext=system_u:system_r:fsdaemon_t tcontext=system_u:object_r:var_lib_t tclass=dir
type=AVC msg=audit(1348173901.081:297): avc: denied { create } for pid=3426
  comm="smartd" name="smartd.WDC_WD2500BEKT_75PVMT0-WD_WXC1A21E0454.ata.state"
  scontext=system_u:system_r:fsdaemon_t tcontext=system_u:object_r:var_lib_t tclass=file
type=AVC msg=audit(1348173901.081:298): avc: denied { write open } for pid=3426
  comm="smartd" name="smartd.WDC_WD2500BEKT_75PVMT0-WD_WXC1A21E0454.ata.state" dev=sda6
  ino=582390 scontext=system_u:system_r:fsdaemon_t tcontext=system_u:object_r:var_lib_t
  tclass=file
type=AVC msg=audit(1348173901.081:299): avc: denied { getattr } for pid=3426
  comm="smartd" path="/var/lib/smartmontools/smartd.WDC_WD2500BEKT_75PVMT0-
  WD_WXC1A21E0454.ata.state" dev=sda6 ino=582390 scontext=system_u:system_r:fsdaemon_t
  tcontext=system_u:object_r:var_lib_t tclass=file
type=AVC msg=audit(1348173901.309:300): avc: denied { append } for pid=1316

```

At first look, the lines in `audit.log` are a bit hard to read. However, on closer examination they are not that hard to understand. Every line can be broken down into sections. For example, the sections in the last line are:

type=AVC:

every SELinux-related audit log line starts with the type identification type=AVC

msg=audit(1348173901.309:300):

This is the time stamp, which unfortunately is written in epoch time, the number of seconds that have passed since Jan 1, 1970. You can use `date -d` on the part up to the dot in the epoch time notation to find out when the event has happened:

```

> date -d @1348173901
Thu Sep 20 16:45:01 EDT 2012

```

avc: denied { append }:

the specific action that was denied. In this case the system has denied the appending of data to a file. While browsing through the audit log file, you can see other system actions, such as write open, getattr and more.

for pid=1316:

the process ID of the command or process that initiated the action

comm="rsyslogd":

the specific command that was associated with that PID

name="smartmontools":

the name of the subject of the action

dev=sda6 ino=582296:

the block device and inode number of the file that was involved

scontext=system_u:system_r:syslogd_t:

the source context, which is the context of the initiator of the action

tclass=file:

a class identification of the subject

Instead of interpreting the events in `audit.log` yourself, there is another approach. You can use the `audit2allow` command, which helps analyze the cryptic log messages in `/var/log/audit/audit.log`. An `audit2allow` troubleshooting session always consists of three different commands. First, you would use `audit2allow -w -a` to present the audit information in a more readable way. The `audit2allow -w -a` by default works on the `audit.log` file. If you want to analyze a specific message in the `audit.log` file, copy it to a temporary file and analyze the file with:

```
> sudo audit2allow -w -i FILENAME
```

EXAMPLE 43.9: ANALYZING AUDIT MESSAGES

```
> sudo audit2allow -w -i testfile
type=AVC msg=audit(1348173901.309:300): avc: denied { append } for pid=1316
comm="rsyslogd" name="acpid" dev=sda6 ino=582296
scontext=system_u:system_r:syslogd_t tcontext=system_u:object_r:apmd_log_t tclass=file
```

This was caused by:

Missing type enforcement (TE) allow rule.

To generate a loadable module to allow this access, run

```
> sudo audit2allow
```

To find out which specific rule has denied access, you can use `audit2allow -a` to show the enforcing rules from all events that were logged to the `audit.log` file, or `audit2allow -i FILENAME` to show it for messages that you have stored in a specific file:

EXAMPLE 43.10: VIEWING WHICH LINES DENY ACCESS

```
> sudo audit2allow -i testfile
#===== syslogd_t =====
allow syslogd_t apmd_log_t:file append;
```

To create an SELinux module with the name `mymodule` that you can load to allow the access that was previously denied, run

```
> sudo audit2allow -a -R -M mymodule
```

If you want to do this for all events that have been logged to the `audit.log`, use the `-a -M` command arguments. To do it for specific messages that are in a specific file, use `-i -M` as in the example below:

EXAMPLE 43.11: CREATING A POLICY MODULE ALLOWING AN ACTION PREVIOUSLY DENIED

```
> sudo audit2allow -i testfile -M example
***** IMPORTANT *****
To make this policy package active, execute:

semodule -i example.pp
```

As indicated by the `audit2allow` command, you can now run this module by using the `semodule -i` command, followed by the name of the module that `audit2allow` has created for you (`example.pp` in the above example).

VII The Linux Audit Framework

- 44 Understanding Linux audit 450
- 45 Setting up the Linux audit framework 483
- 46 Introducing an audit rule set 495
- 47 Useful resources 506

44 Understanding Linux audit

The Linux audit framework as shipped with this version of SUSE Linux Enterprise Server provides a CAPP-compliant (Controlled Access Protection Profiles) auditing system that reliably collects information about any security-relevant event. The audit records can be examined to determine whether any violation of the security policies has been committed, and by whom.

Providing an audit framework is an important requirement for a CC-CAPP/EAL (Common Criteria-Controlled Access Protection Profiles/Evaluation Assurance Level) certification. Common Criteria (CC) for Information Technology Security Information is an international standard for independent security evaluations. Common Criteria helps customers judge the security level of any IT product they intend to deploy in mission-critical setups.

Common Criteria security evaluations have two sets of evaluation requirements, functional and assurance requirements. Functional requirements describe the security attributes of the product under evaluation and are summarized under the Controlled Access Protection Profiles (CAPP). Assurance requirements are summarized under the Evaluation Assurance Level (EAL). EAL describes any activities that must take place for the evaluators to be confident that security attributes are present, effective and implemented. Examples for activities of this kind include documenting the developers' search for security vulnerabilities, the patch process, and testing.

This guide provides a basic understanding of how audit works and how it can be set up. For more information about Common Criteria itself, refer to [the Common Criteria Web site \(https://www.commoncriteriaportal.org/\)](https://www.commoncriteriaportal.org/) ↗.

Linux audit helps make your system more secure by providing you with a means to analyze what is happening on your system in great detail. It does not, however, provide additional security itself—it does not protect your system from code malfunctions or any kind of exploits. Instead, audit is useful for tracking these issues and helps you take additional security measures, like AppArmor, to prevent them.

Audit consists of several components, each contributing crucial functionality to the overall framework. The audit kernel module intercepts the system calls and records the relevant events. The `auditd` daemon writes the audit reports to disk. Various command-line utilities take care of displaying, querying and archiving the audit trail.

Audit enables you to do the following:

Associate users with processes

Audit maps processes to the user ID that started them. This makes it possible for the administrator or security officer to exactly trace which user owns which process and is potentially doing malicious operations on the system.

Important: Renaming user IDs

Audit does not handle the renaming of UIDs. Therefore avoid renaming UIDs (for example, changing `tux` from `uid=1001` to `uid=2000`) and obsolete UIDs rather than renaming them. Otherwise you would need to change `auditctl` data (audit rules) and would have problems retrieving old data correctly.

Review the audit trail

Linux audit provides tools that write the audit reports to disk and translate them into human readable format.

Review particular audit events

Audit provides a utility that allows you to filter the audit reports for certain events of interest. You can filter for:

- User
- Group
- Audit ID
- Remote Host Name
- Remote Host Address
- System Call
- System Call Arguments

- File
- File Operations
- Success or Failure

Apply a selective audit

Audit provides the means to filter the audit reports for events of interest and to tune audit to record selected events. You can create your own set of rules and have the audit daemon record those of interest to you.

Guarantee the availability of the report data

Audit reports are owned by `root` and removable by `root`. Unauthorized users cannot remove the audit logs.

Prevent audit data loss

If the kernel runs out of memory, the audit daemon's backlog is exceeded, or its rate limit is exceeded, audit can trigger a shutdown of the system to keep events from escaping audit's control. This shutdown would be an immediate halt of the system triggered by the audit kernel component without synchronizing the latest logs to disk. The default configuration is to log a warning to syslog rather than to halt the system.

If the system runs out of disk space when logging, the audit system can be configured to perform clean shutdown. The default configuration tells the audit daemon to stop logging when it runs out of disk space.

44.1 Introducing the components of Linux audit



Important: audispd merged into auditd

In SUSE Linux Enterprise Server 15 SP4 the code for `audispd` has been merged into `auditd`. All `audispd` configurations are now in `/etc/audit/auditd.conf` and `/etc/audit/plugins.d`.

The following figure illustrates how the various components of audit interact with each other:

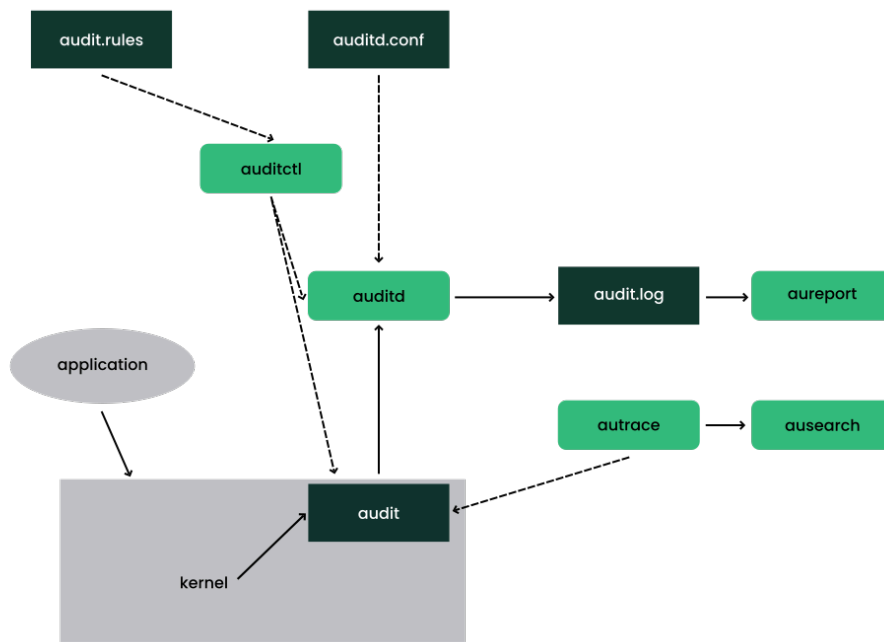

FIGURE 44.1: INTRODUCING THE COMPONENTS OF LINUX AUDIT

Straight arrows represent the data flow between components while dashed arrows represent lines of control between components.

auditd

The audit daemon writes the audit messages that were generated through the audit kernel interface and triggered by application and system activity to disk. The way the audit daemon is started is controlled by `systemd`. The audit system functions (when started) are controlled by `/etc/audit/auditd.conf`. For more information about `auditd` and its configuration, refer to [Section 44.2, “Configuring the audit daemon”](#).

auditctl

The `auditctl` utility controls the audit system. It controls the log generation parameters and kernel settings of the audit interface and the rule sets that determine which events are tracked. For more information about `auditctl`, refer to [Section 44.3, “Controlling the audit system using auditctl”](#).

audit rules

The file `/etc/audit/audit.rules` contains a sequence of `auditctl` commands that are loaded at system boot time immediately after the audit daemon is started. For more information about audit rules, refer to [Section 44.4, “Passing parameters to the audit system”](#).

aureport

The **aureport** utility allows you to create custom reports from the audit event log. This report generation can easily be scripted, and the output can be used by various other applications, for example, to plot these results. For more information about **aureport**, refer to [Section 44.5, “Understanding the audit logs and generating reports”](#).

ausearch

The **ausearch** utility can search the audit log file for certain events using various keys or other characteristics of the logged format. For more information about **ausearch**, refer to [Section 44.6, “Querying the audit daemon logs with ausearch”](#).

autrace

The **autrace** utility traces individual processes in a fashion similar to **strace**. The output of **autrace** is logged to the audit log. For more information about **autrace**, refer to [Section 44.7, “Analyzing processes with autrace”](#).

aulast

Prints a list of the last logged-in users, similarly to **last**. **aulast** searches back through the audit logs (or the given audit log file) and displays a list of all users logged in and out based on the range of time in the audit logs.

aulastlog

Prints the last login for all users of a machine similar to the way **lastlog** does. The login name, port and last login time are printed.

44.2 Configuring the audit daemon

Before you can start generating audit logs and processing them, configure the audit daemon itself. The `/etc/audit/auditd.conf` configuration file determines how the audit system functions when the daemon has been started. For most use cases, the default settings shipped with SUSE Linux Enterprise Server should suffice. For CAPP environments, most of these parameters need tweaking. The following example is the default configuration:

EXAMPLE 44.1: DEFAULT /ETC/AUDIT/AUDITD.CONF

```
local_events = yes
write_logs = yes
log_file = /var/log/audit/audit.log
```



```
log_group = audit
log_format = RAW
flush = INCREMENTAL_ASYNC
freq = 50
max_log_file = 8
num_logs = 5
priority_boost = 4
name_format = NONE
##name = mydomain
max_log_file_action = ROTATE
space_left = 75
space_left_action = SYSLOG
verify_email = yes
action_mail_acct = root
admin_space_left = 50
admin_space_left_action = SUSPEND
disk_full_action = SUSPEND
disk_error_action = SUSPEND
use_libwrap = yes
##tcp_listen_port = 60
tcp_listen_queue = 5
tcp_max_per_addr = 1
##tcp_client_ports = 1024-65535
tcp_client_max_idle = 0
transport = TCP
distribute_network = no
q_depth = 1200
overflow_action = SYSLOG
max_restarts = 10
plugin_dir = /etc/audit/plugins.d
end_of_event_timeout = 2
```

Refer to [man 5 auditd.conf](#) for an explanation of these options.

Depending on whether you want your environment to satisfy the requirements of CAPP, you need to be extra restrictive when configuring the audit daemon. Where you need to use particular settings to meet the CAPP requirements, a “CAPP Environment” note tells you how to adjust the configuration.

When the daemon configuration in [/etc/audit/auditd.conf](#) is complete, the next step is to focus on controlling the amount of auditing the daemon does, and to assign sufficient resources and limits to the daemon so it can operate smoothly.

44.3 Controlling the audit system using **auditctl**

auditctl controls the status and basic system parameters of the audit daemon. It controls the amount of auditing performed on the system. Using audit rules, **auditctl** controls which components of your system are subjected to the audit and to what extent they are audited. Audit rules can be passed to the audit daemon on the **auditctl** command line or by composing a rule set and instructing the audit daemon to process this file. By default, the **auditd** daemon is configured to check for audit rules under `/etc/audit/audit.rules`. For more details on audit rules, refer to [Section 44.4, "Passing parameters to the audit system"](#).

The main **auditctl** commands to control basic audit system parameters are:

- **auditctl -e** to enable or disable audit
- **auditctl -f** to control the failure flag
- **auditctl -r** to control the rate limit for audit messages
- **auditctl -b** to control the backlog limit
- **auditctl -s** to query the current status of the audit daemon
- **auditctl -S** specifies which system call to audit. Before running **auditctl -S** on your system, add `-F arch=b64` to prevent the architecture mismatch warning.

The `-e`, `-f`, `-r`, and `-b` options can also be specified in the `audit.rules` file to avoid having to enter them each time the audit daemon is started.

Any time you query the status of the audit daemon with **auditctl -s** or change the status flag with **auditctl -eFLAG**, a status message (including information on each of the above-mentioned parameters) is printed. The following example highlights the typical audit status message.

EXAMPLE 44.2: EXAMPLE OUTPUT OF **auditctl -s**

```
enabled 1
failure 1
pid 790
rate_limit 0
backlog_limit 64
lost 0
backlog 0
backlog_wait_time 15000
loginuid_immutable 0 unlocked
```

TABLE 44.1: AUDIT STATUS FLAGS

Flag	Meaning [Possible Values]	Command
<u>enabled</u>	Set the enable flag. [0..2] 0 = disable, 1 = enable, 2 = enable and lock down the configuration. Note that this disables logging syscalls, and other events may still be logged. (See <u>man 3 au-</u> <u>dit_set_enabled</u> in the <u>audit-devel</u> .)	<u>auditctl</u> <u>-e [0 1 2]</u>
<u>flag</u>	Set the failure flag. [0..2] 0 = silent, 1 = printk, 2 = pan- ic (immediate halt without synchronizing pending data to disk)	<u>auditctl</u> <u>-f [0 1 2]</u>
<u>pid</u>	Process ID under which <u>au-</u> <u>ditd</u> is running.	—
<u>rate_limit</u>	Set a limit in messages per second. If the rate is not zero and is exceeded, the action specified in the failure flag is triggered.	<u>auditctl</u> <u>-r RATE</u>
<u>backlog_limit</u>	Specify the maximum num- ber of outstanding audit buffers allowed. If all buffers are full, the action speci- fied in the failure flag is trig- gered.	<u>auditctl</u> <u>-b BACKLOG</u>
<u>lost</u>	Count the current number of lost audit messages.	—

Flag	Meaning [Possible Values]	Command
<code>backlog</code>	Count the current number of outstanding audit buffers.	—

44.4 Passing parameters to the audit system

Commands to control the audit system can be invoked individually from the shell using `auditctl` or batch read from a file using `auditctl - R`. This latter method is used by the init scripts to load rules from the file `/etc/audit/audit.rules` after the audit daemon has been started. The rules are executed in order from top to bottom. Each of these rules would expand to a separate `auditctl` command. The syntax used in the rules file is the same as that used for the `auditctl` command.

Changes made to the running audit system by executing `auditctl` on the command line are not persistent across system restarts. For changes to persist, add them to the `/etc/audit/audit.rules` file and, if they are not currently loaded into audit, restart the audit system to load the modified rule set by using the `systemctl restart auditd` command.

EXAMPLE 44.3: EXAMPLE AUDIT RULES—AUDIT SYSTEM PARAMETERS

```
-b 1000 ❶
-f 1 ❷
-r 10 ❸
-e 1 ❹
```

- ❶ Specify the maximum number of outstanding audit buffers. Depending on the level of logging activity, you might need to adjust the number of buffers to avoid causing too heavy an audit load on your system.
- ❷ Specify the failure flag to use. See *Table 44.1, "Audit status flags"* for possible values.
- ❸ Specify the maximum number of messages per second that may be issued by the kernel. See *Table 44.1, "Audit status flags"* for details.
- ❹ Enable or disable the audit subsystem.

Using audit, you can track any kind of file system access to important files, configurations or resources. You can add watches on these and assign keys to each kind of watch for better identification in the logs.

EXAMPLE 44.4: EXAMPLE AUDIT RULES—FILE SYSTEM AUDITING

```
-w /etc/shadow ❶  
-w /etc -p rx ❷  
-w /etc/passwd -k fk_passwd -p rwx ❸
```

- ❶ The `-w` option tells audit to add a watch to the file specified, in this case `/etc/shadow`. All system calls requesting access permissions to this file are analyzed.
- ❷ This rule adds a watch to the `/etc` directory and applies permission filtering for read and execute access to this directory (`-p rx`). Any system call requesting any of these two permissions is analyzed. The creation of new files and the deletion of existing ones are logged as directory-related events. To get more specific events for files located under this particular directory, you should add a separate rule for each file. A file must exist before you add a rule containing a watch on it. Auditing files as they are created is not supported.
- ❸ This rule adds a file watch to `/etc/passwd`. Permission filtering is applied for read, write, execute, and attribute change permissions. The `-k` option allows you to specify a key to use to filter the audit logs for this particular event later (for example with `ausearch`). You may use the same key on different rules to be able to group rules when searching for them. It is also possible to apply multiple keys to a rule.

System call auditing lets you track your system's behavior on a level even below the application level. When designing these rules, consider that auditing a great many system calls may increase your system load and cause you to run out of disk space. Consider carefully which events need tracking and how they can be filtered to be even more specific.

EXAMPLE 44.5: EXAMPLE AUDIT RULES—SYSTEM CALL AUDITING

```
-a exit,always -S mkdir ❶  
-a exit,always -S access -F a1=4 ❷  
-a exit,always -S ipc -F a0=2 ❸  
-a exit,always -S open -F success!=0 ❹  
-a task,always -F auid=0 ❺  
-a task,always -F uid=0 -F auid=501 -F gid=wheel ❻
```

- ❶ This rule activates auditing for the `mkdir` system call. The `-a` option adds system call rules. This rule triggers an event whenever the `mkdir` system call is entered (`exit, always`). The `-S` option specifies the system call to which this rule should be applied.
- ❷ This rule adds auditing to the `access` system call, but only if the second argument of the system call (`mode`) is `4` (`R_OK`). `exit,always` tells audit to add an audit context to this system call when entering it, and to write out a report when it gets audited.

- ③ This rule adds an audit context to the IPC multiplexed system call. The specific `ipc` system call is passed as the first syscall argument and can be selected using `-F a0=IPC_CALL_NUMBER`.
- ④ This rule audits failed attempts to call open.
- ⑤ This rule is an example of a task rule (keyword: `task`). It is different from the other rules above in that it applies to processes that are forked or cloned. To filter these kinds of events, you can use fields that are known at fork time, such as UID, GID, and AUID. This example rule filters for all tasks carrying an audit ID of `0`.
- ⑥ This last rule makes heavy use of filters. All filter options are combined with a logical AND operator, meaning that this rule applies to all tasks that carry the audit ID of `501`, run as `root`, and have `wheel` as the group. A process is given an audit ID on user login. This ID is then handed down to any child process started by the initial process of the user. Even if the user changes their identity, the audit ID stays the same and allows tracing actions to the original user.



Tip: Filtering system call arguments

For more details on filtering system call arguments, refer to [Section 46.6, “Filtering system call arguments”](#).

You cannot only add rules to the audit system, but also remove them. There are different methods for deleting the entire rule set at once or for deleting system call rules or file and directory watches:

EXAMPLE 44.6: DELETING AUDIT RULES AND EVENTS

```
-D ①  
-d exit,always -S mkdir ②  
-W /etc ③
```

- ① Clear the queue of audit rules and delete any preexisting rules. This rule is used as the first rule in `/etc/audit/audit.rules` files to make sure that the rules that are about to be added do not clash with any preexisting ones. The `auditctl -D` command is also used before doing an `autrace` to avoid having the trace rules clash with any rules present in the `audit.rules` file.
- ② This rule deletes a system call rule. The `-d` option must precede any system call rule that needs to be deleted from the rule queue, and must match exactly.

- ③ This rule tells audit to discard the rule with the directory watch on `/etc` from the rules queue. This rule deletes any rule containing a directory watch on `/etc`, regardless of any permission filtering or key options.

To get an overview of which rules are currently in use in your audit setup, run `auditctl -l`. This command displays all rules with one rule per line.

EXAMPLE 44.7: LISTING RULES WITH `auditctl -l`

```
exit,always watch=/etc perm=rx
exit,always watch=/etc/passwd perm=rwx key=fk_passwd
exit,always watch=/etc/shadow perm=rwx
exit,always syscall=mkdir
exit,always a1=4 (0x4) syscall=access
exit,always a0=2 (0x2) syscall=ipc
exit,always success!=0 syscall=open
```



Note: Creating filter rules

You can build sophisticated audit rules by using the various filter options. Refer to the `auditctl(8)` man page for more information about the options available for building audit filter rules and audit rules.

44.5 Understanding the audit logs and generating reports

To understand what the `aureport` utility does, it is vital to know how the logs generated by the audit daemon are structured, and what exactly is recorded for an event. Then you can decide which report types are most appropriate for your needs.

44.5.1 Understanding the audit logs

The following examples highlight two typical events that are logged by audit and how their trails in the audit log are read. The audit log or logs (if log rotation is enabled) are stored in the `/var/log/audit` directory.

The logs record two types of information: record types and event fields. The record types are identified by `type=` in each log entry. Event fields are all other items on the left side of the equals signs. In the following examples, `type=SYSCALL` and `type=CWD` are record types, and `arch=c000003e` and `syscall=2` are event fields, followed by their values.

Refer to the `/usr/include/libaudit.h` file (from the `audit-devel` package) to see a complete list of record types and their definitions.

Run the `ausyscall --dump` command to see a table of syscall numbers, and what they represent:

```
> ausyscall --dump
Using x86_64 syscall table:
0      read
1      write
2      open
3      close
4      stat
5      fstat
[...]
```

The first example is a simple `less` command. The second example covers a great deal of PAM activity in the logs when a user tries to remotely log in to a machine running audit.

EXAMPLE 44.8: A SIMPLE AUDIT EVENT—VIEWING THE AUDIT LOG

```
type=SYSCALL msg=audit(1234874638.599:5207): arch=c000003e syscall=2
success=yes exit=4 a0=62fb60 a1=0 a2=31 a3=0 items=1 ppid=25400 pid
=25616 auid=0 uid=0 gid=0 euid=0 suid=0 fsuid=0 egid=0 sgid=0 fsgid=0
tty=pts1 ses=1164 comm="less" exe="/usr/bin/less" key="doc_log"
type=CWD msg=audit(1234874638.599:5207): cwd="/root"
type=PATH msg=audit(1234874638.599:5207): item=0 name="/var/log/audit/
audit.log" inode=1219041 dev=08:06 mode=0100644 ouid=0 ogid=0 rdev=00:00
```

The above event, a simple `less /var/log/audit/audit.log`, wrote three messages to the log. All of them are closely linked together and you would not be able to make sense of one of them without the others. The first message reveals the following information:

type

The type of event recorded. In this case, it assigns the `SYSCALL` type to an event triggered by a system call. The `CWD` event was recorded to record the current working directory at the time of the syscall. A `PATH` event is generated for each path passed to the system call. The open system call takes one path argument and generates one `PATH` event. It

is important to understand that the PATH event reports the path name string argument without any further interpretation, so a relative path requires manual combination with the path reported by the CWD event to determine the object accessed.

msg

A message ID enclosed in brackets. The ID splits into two parts. All characters before the : represent a Unix epoch time stamp. The number after the colon represents the actual event ID. All events that are logged from one application's system call have the same event ID. If the application makes a second system call, it gets another event ID.

arch

References the CPU architecture of the system call. Decode this information using the -i option on any of your ausearch commands when searching the logs.

syscall

The type of system call as it would have been printed by an strace on this particular system call. This data is taken from the list of system calls under /usr/include/asm/unistd.h and may vary depending on the architecture. In this case, syscall=2 refers to the open system call (see man open(2)) invoked by the less application.

success

Whether the system call succeeded or failed.

exit

The exit value returned by the system call. For the open system call used in this example, this is the file descriptor number. This varies by system call.

a0 to a3

The first four arguments to the system call in numeric form. The values of these are system call dependent. In this example (an open system call), the following are used:

```
a0=62fb60 a1=8000 a2=31 a3=0
```

a0 is the start address of the passed path. a1 is the flags. 8000 in hex notation translates to 100000 in octal notation, which in turn translates to O_LARGEFILE. a2 is the mode, which, because O_CREAT was not specified, is unused. a3 is not passed by the open system call. Check the manual page of the relevant system call to find out which arguments are used with it.

items

The number of strings passed to the application.

ppid

The process ID of the parent of the process analyzed.

pid

The process ID of the process analyzed.

audit

The audit ID. A process is given an audit ID on user login. This ID is then handed down to any child process started by the initial process of the user. Even if the user changes their identity (for example, becomes root), the audit ID stays the same. Thus you can always trace actions to the original user who logged in.

uid

The user ID of the user who started the process. In this case, 0 for root .

gid

The group ID of the user who started the process. In this case, 0 for root .

euid, suid, fsuid

Effective user ID, set user ID, and file system user ID of the user that started the process.

egid, sgid, fsgid

Effective group ID, set group ID, and file system group ID of the user that started the process.

tty

The terminal from which the application was started. In this case, a pseudo-terminal used in an SSH session.

ses

The login session ID. This process attribute is set when a user logs in and can tie any process to a particular user login.

comm

The application name under which it appears in the task list.

exe

The resolved path to the binary program.

subj

auditd records whether the process is subject to any security context, such as AppArmor. unconstrained, as in this case, means that the process is not confined with AppArmor. If the process had been confined, the binary path plus the AppArmor profile mode would have been logged.

key

If you are auditing many directories or files, assign key strings to each of these watches. You can use these keys with ausearch to search the logs for events of this type.

The second message triggered by the example less call does not reveal anything apart from the current working directory when the less command was executed.

The third message reveals the following (the type and message flags have already been introduced):

item

In this example, item references the a0 argument—a path—that is associated with the original SYSCALL message. Had the original call had more than one path argument (such as a cp or mv command), an additional PATH event would have been logged for the second path argument.

name

Refers to the path passed as an argument to the open system call.

inode

Refers to the inode number corresponding to name.

dev

Specifies the device on which the file is stored. In this case, 08:06, which stands for /dev/sda1 or “first partition on the first IDE device.”

mode

Numerical representation of the file's access permissions. In this case, root has read and write permissions and their group (root) has read access while the entire rest of the world cannot access the file.

ouid and ogid

Refer to the UID and GID of the inode itself.

rdev

Not applicable for this example. The `rdev` entry applies to block or character devices, not to files.

Example 44.9, “An advanced audit event—login via SSH” highlights the audit events triggered by an incoming SSH connection. Most of the messages are related to the PAM stack and reflect the different stages of the SSH PAM process. Several of the audit messages carry nested PAM messages in them that signify that a particular stage of the PAM process has been reached. Although the PAM messages are logged by audit, audit assigns its own message type to each event:

EXAMPLE 44.9: AN ADVANCED AUDIT EVENT—LOGIN VIA SSH

```
type=USER_AUTH msg=audit(1234877011.791:7731): user pid=26127 uid=0 ❶
aid=4294967295 ses=4294967295 msg='op=PAM:authentication acct="root" exe="/usr/sbin/
sshd"
(hostname=jupiter.example.com, addr=192.168.2.100, terminal=ssh res=success)'
type=USER_ACCT msg=audit(1234877011.795:7732): user pid=26127 uid=0 ❷
aid=4294967295 ses=4294967295 msg='op=PAM:accounting acct="root" exe="/usr/sbin/sshd"
(hostname=jupiter.example.com, addr=192.168.2.100, terminal=ssh res=success)'
type=CRED_ACQ msg=audit(1234877011.799:7733): user pid=26125 uid=0 ❸
aid=4294967295 ses=4294967295 msg='op=PAM:setcred acct="root" exe="/usr/sbin/sshd"
(hostname=jupiter.example.com, addr=192.168.2.100, terminal=/dev/pts/0 res=success)'
type=LOGIN msg=audit(1234877011.799:7734): login pid=26125 uid=0
old aid=4294967295 new aid=0 old ses=4294967295 new ses=1172
type=USER_START msg=audit(1234877011.799:7735): user pid=26125 uid=0 ❹
aid=0 ses=1172 msg='op=PAM:session_open acct="root" exe="/usr/sbin/sshd"
(hostname=jupiter.example.com, addr=192.168.2.100, terminal=/dev/pts/0 res=success)'
type=USER_LOGIN msg=audit(1234877011.823:7736): user pid=26128 uid=0 ❺
aid=0 ses=1172 msg='uid=0: exe="/usr/sbin/sshd"
(hostname=jupiter.example.com, addr=192.168.2.100, terminal=/dev/pts/0 res=success)'
type=CRED_REFR msg=audit(1234877011.828:7737): user pid=26128 uid=0 ❻
aid=0 ses=1172 msg='op=PAM:setcred acct="root" exe="/usr/sbin/sshd"
(hostname=jupiter.example.com, addr=192.168.2.100, terminal=/dev/pts/0 res=success)'
```

- ❶ PAM reports that it has successfully requested user authentication for `root` from a remote host (`jupiter.example.com`, `192.168.2.100`). The terminal where this is happening is `ssh`.
- ❷ PAM reports that it has successfully determined whether the user is authorized to log in.
- ❸ PAM reports that the appropriate credentials to log in have been acquired and that the terminal changed to a normal terminal (`/dev/pts/0`).
- ❹ PAM reports that it has successfully opened a session for `root`.

- 5 The user has successfully logged in. This event is the one used by `aureport -l` to report about user logins.
- 6 PAM reports that the credentials have been successfully reacquired.

44.5.2 Generating custom audit reports

The raw audit reports stored in the `/var/log/audit` directory tend to become bulky and hard to understand. To more easily find relevant messages, use the `aureport` utility and create custom reports.

The following use cases highlight a few of the possible report types that you can generate with `aureport`:

Read audit logs from another file

When the audit logs have moved to another machine or when you want to analyze the logs of several machines on your local machine without wanting to connect to each of these individually, move the logs to a local file and have `aureport` analyze them locally:

```
> sudo aureport -if myfile

Summary Report
=====
Range of time in logs: 03/02/09 14:13:38.225 - 17/02/09 14:52:27.971
Selected time for report: 03/02/09 14:13:38 - 17/02/09 14:52:27.971
Number of changes in configuration: 13
Number of changes to accounts, groups, or roles: 0
Number of logins: 6
Number of failed logins: 13
Number of authentications: 7
Number of failed authentications: 573
Number of users: 1
Number of terminals: 9
Number of host names: 4
Number of executables: 17
Number of files: 279
Number of AVC's: 0
Number of MAC events: 0
Number of failed syscalls: 994
Number of anomaly events: 0
Number of responses to anomaly events: 0
Number of crypto events: 0
Number of keys: 2
Number of process IDs: 1211
```

```
Number of events: 5320
```

The above command, **aureport** without any arguments, provides the standard general summary report generated from the logs contained in `myfile`. To create more detailed reports, combine the `-if` option with any of the options below. For example, generate a login report that is limited to a certain time frame:

```
> sudo aureport -l -ts 14:00 -te 15:00 -if myfile

Login Report
=====
# date time auid host term exe success event
=====
1. 17/02/09 14:21:09 root: 192.168.2.100 sshd /usr/sbin/sshd no 7718
2. 17/02/09 14:21:15 0 jupiter /dev/pts/3 /usr/sbin/sshd yes 7724
```

Convert numeric entities to text

Some information, such as user IDs, are printed in numeric form. To convert these into a human-readable text format, add the `-i` option to your **aureport** command.

Create a rough summary report

If you are interested in the current audit statistics (events, logins, processes, etc.), run **aureport** without any other option.

Create a summary report of failed events

To break down the overall statistics of plain `aureport` to the statistics of failed events, use `aureport --failed`:

```
> sudo aureport --failed

Failed Summary Report
=====
Range of time in logs: 03/02/09 14:13:38.225 - 17/02/09 14:57:35.183
Selected time for report: 03/02/09 14:13:38 - 17/02/09 14:57:35.183
Number of changes in configuration: 0
Number of changes to accounts, groups, or roles: 0
Number of logins: 0
Number of failed logins: 13
Number of authentications: 0
Number of failed authentications: 574
Number of users: 1
Number of terminals: 5
Number of host names: 4
Number of executables: 11
Number of files: 77
Number of AVC's: 0
Number of MAC events: 0
Number of failed syscalls: 994
Number of anomaly events: 0
Number of responses to anomaly events: 0
Number of crypto events: 0
Number of keys: 2
Number of process IDs: 708
Number of events: 1583
```

Create a summary report of successful events

If you want to break down the overall statistics of a plain `aureport` to the statistics of successful events, use `aureport --success`:

```
> sudo aureport --success

Success Summary Report
=====
Range of time in logs: 03/02/09 14:13:38.225 - 17/02/09 15:00:01.535
Selected time for report: 03/02/09 14:13:38 - 17/02/09 15:00:01.535
Number of changes in configuration: 13
Number of changes to accounts, groups, or roles: 0
Number of logins: 6
Number of failed logins: 0
Number of authentications: 7
```

```
Number of failed authentications: 0
Number of users: 1
Number of terminals: 7
Number of host names: 3
Number of executables: 16
Number of files: 215
Number of AVC's: 0
Number of MAC events: 0
Number of failed syscalls: 0
Number of anomaly events: 0
Number of responses to anomaly events: 0
Number of crypto events: 0
Number of keys: 2
Number of process IDs: 558
Number of events: 3739
```

Create summary reports

In addition to the dedicated summary reports (main summary and failed and success summary), use the `--summary` option with most of the other options to create summary reports for a particular area of interest. Not all reports support this option, however. This example creates a summary report for user login events:

```
> sudo aureport -u -i --summary
```

```
User Summary Report
=====
total  auid
=====
5640  root
13    tux
3     wilber
```

Create a report of events

To get an overview of the events logged by audit, use the `aureport -e` command. This command generates a numbered list of all events including date, time, event number, event type, and audit ID.

```
> sudo aureport -e -ts 14:00 -te 14:21
```

```
Event Report
=====
# date time event type auid success
=====
1. 17/02/09 14:20:27 7462 DAEMON_START 0 yes
2. 17/02/09 14:20:27 7715 CONFIG_CHANGE 0 yes
```



```
3. 17/02/09 14:20:57 7716 USER_END 0 yes
4. 17/02/09 14:20:57 7717 CRED_DISP 0 yes
5. 17/02/09 14:21:09 7718 USER_LOGIN -1 no
6. 17/02/09 14:21:15 7719 USER_AUTH -1 yes
7. 17/02/09 14:21:15 7720 USER_ACCT -1 yes
8. 17/02/09 14:21:15 7721 CRED_ACQ -1 yes
9. 17/02/09 14:21:15 7722 LOGIN 0 yes
10. 17/02/09 14:21:15 7723 USER_START 0 yes
11. 17/02/09 14:21:15 7724 USER_LOGIN 0 yes
12. 17/02/09 14:21:15 7725 CRED_REFR 0 yes
```

Create a report from all process events

To analyze the log from a process's point of view, use the `aureport -p` command. This command generates a numbered list of all process events including date, time, process ID, name of the executable, system call, audit ID, and event number.

```
aureport -p
```

```
Process ID Report
```

```
=====
```

```
# date time pid exe syscall audit event
```

```
=====
```

```
1. 13/02/09 15:30:01 32742 /usr/sbin/cron 0 0 35
2. 13/02/09 15:30:01 32742 /usr/sbin/cron 0 0 36
3. 13/02/09 15:38:34 32734 /usr/lib/gdm/gdm-session-worker 0 -1 37
```

Create a report from all system call events

To analyze the audit log from a system call's point of view, use the `aureport -s` command. This command generates a numbered list of all system call events including date, time, number of the system call, process ID, name of the command that used this call, audit ID, and event number.

```
> sudo aureport -s
```

```
Syscall Report
```

```
=====
```

```
# date time syscall pid comm audit event
```

```
=====
```

```
1. 16/02/09 17:45:01 2 20343 cron -1 2279
2. 16/02/09 17:45:02 83 20350 mktemp 0 2284
3. 16/02/09 17:45:02 83 20351 mkdir 0 2285
```

Create a report from all executable events

To analyze the audit log from an executable's point of view, use the `aureport -x` command. This command generates a numbered list of all executable events including date, time, name of the executable, the terminal it is run in, the host executing it, the audit ID, and event number.

```
aureport -x

Executable Report
=====
# date time exe term host auid event
=====
1. 13/02/09 15:08:26 /usr/sbin/sshd sshd 192.168.2.100 -1 12
2. 13/02/09 15:08:28 /usr/lib/gdm/gdm-session-worker :0 ? -1 13
3. 13/02/09 15:08:28 /usr/sbin/sshd ssh 192.168.2.100 -1 14
```

Create a report about files

To generate a report from the audit log that focuses on file access, use the `aureport -f` command. This command generates a numbered list of all file-related events including date, time, name of the accessed file, number of the system call accessing it, success or failure of the command, the executable accessing the file, audit ID, and event number.

```
> sudo aureport -f

File Report
=====
# date time file syscall success exe auid event
=====
1. 16/02/09 17:45:01 /etc/shadow 2 yes /usr/sbin/cron -1 2279
2. 16/02/09 17:45:02 /tmp/ 83 yes /bin/mktemp 0 2284
3. 16/02/09 17:45:02 /var 83 no /bin/mkdir 0 2285
```

Create a report about users

To generate a report from the audit log that illustrates which users are running what executables on your system, use the `aureport -u` command. This command generates a numbered list of all user-related events including date, time, audit ID, terminal used, host, name of the executable, and an event ID.

```
aureport -u

User ID Report
=====
# date time auid term host exe event
```

```

=====
1. 13/02/09 15:08:26 -1 sshd 192.168.2.100 /usr/sbin/sshd 12
2. 13/02/09 15:08:28 -1 :0 ? /usr/lib/gdm/gdm-session-worker 13
3. 14/02/09 08:25:39 -1 ssh 192.168.2.101 /usr/sbin/sshd 14

```

Create a report about logins

To create a report that focuses on login attempts to your machine, run the `aureport -l` command. This command generates a numbered list of all login-related events including date, time, audit ID, host and terminal used, name of the executable, success or failure of the attempt, and an event ID.

```

> sudo aureport -l -i

Login Report
=====
# date time auid host term exe success event
=====
1. 13/02/09 15:08:31 tux: 192.168.2.100 sshd /usr/sbin/sshd no 19
2. 16/02/09 12:39:05 root: 192.168.2.101 sshd /usr/sbin/sshd no 2108
3. 17/02/09 15:29:07 geeko: ? tty3 /bin/login yes 7809

```

Limit a report to a certain time frame

To analyze the logs for a particular time frame, such as the working hours of Feb 16, 2009, first find out whether this data is contained in the current `audit.log` or whether the logs have been rotated in by running `aureport -t`:

```

aureport -t

Log Time Range Report
=====
/var/log/audit/audit.log: 03/02/09 14:13:38.225 - 17/02/09 15:30:01.636

```

The current `audit.log` contains all the desired data. Otherwise, use the `-if` option to point the `aureport` commands to the log file that contains the needed data.

Then, specify the start date and time and the end date and time of the desired time frame and combine it with the report option needed. This example focuses on login attempts:

```

> sudo aureport -ts 02/16/09 8:00 -te 02/16/09 18:00 -l

Login Report
=====
# date time auid host term exe success event
=====
1. 16/02/09 12:39:05 root: 192.168.2.100 sshd /usr/sbin/sshd no 2108

```

```
2. 16/02/09 12:39:12 0 192.168.2.100 /dev/pts/1 /usr/sbin/sshd yes 2114
3. 16/02/09 13:09:28 root: 192.168.2.100 sshd /usr/sbin/sshd no 2131
4. 16/02/09 13:09:32 root: 192.168.2.100 sshd /usr/sbin/sshd no 2133
5. 16/02/09 13:09:37 0 192.168.2.100 /dev/pts/2 /usr/sbin/sshd yes 2139
```

The start date and time are specified with the `-ts` option. Any event that has a time stamp equal to or after your given start time appears in the report. If you omit the date, **aureport** assumes that you meant *today*. If you omit the time, it assumes that the start time should be midnight of the date specified.

Specify the end date and time with the `-te` option. Any event that has a time stamp equal to or before your given event time appears in the report. If you omit the date, **aureport** assumes that you meant today. If you omit the time, it assumes that the end time should be now. Use the same format for the date and time as for `-ts`.

All reports except the summary ones are printed in column format and sent to STDOUT, which means that this data can be written to other commands easily. The visualization scripts introduced in [Section 44.8, “Visualizing audit data”](#) are examples of how to further process the data generated by audit.

44.6 Querying the audit daemon logs with **ausearch**

The **aureport** tool helps you to create overall summaries of what is happening on the system, but if you are interested in the details of a particular event, **ausearch** is the tool to use.

ausearch allows you to search the audit logs using special keys and search phrases that relate to most of the flags that appear in event messages in `/var/log/audit/audit.log`. Not all record types contain the same search phrases. There are no `hostname` or `uid` entries in a `PATH` record, for example.

When searching, make sure that you choose appropriate search criteria to catch all records you need. Otherwise, you could be searching for a specific type of record and still get various other related records along with it. This is caused by different parts of the kernel contributing additional records for events that are related to the one to find. For example, you would always get a `PATH` record along with the `SYSCALL` record for an `open` system call.



Tip: Using multiple search options

Any of the command line options can be combined with logical AND operators to narrow down your search.

Read audit logs from another file

When the audit logs have moved to another machine or when you want to analyze the logs of several machines on your local machine without wanting to connect to each of these individually, move the logs to a local file and have `ausearch` search them locally:

```
> sudo ausearch -option -if myfile
```

Convert numeric results into text

Some information, such as user IDs are printed in numeric form. To convert these into human readable text format, add the `-i` option to your `ausearch` command.

Search by audit event ID

If you have previously run an audit report or done an `autrace`, you should analyze the trail of a particular event in the log. Most of the report types described in [Section 44.5, "Understanding the audit logs and generating reports"](#) include audit event IDs in their output. An audit event ID is the second part of an audit message ID, which consists of a Unix epoch time stamp and the audit event ID separated by a colon. All events that are logged from one application's system call have the same event ID. Use this event ID with `ausearch` to retrieve this event's trail from the log.

Use a command similar to the following:

```
> sudo ausearch -a 5207
----
time->Tue Feb 17 13:43:58 2009
type=PATH msg=audit(1234874638.599:5207): item=0 name="/var/log/audit/audit.log"
inode=1219041 dev=08:06 mode=0100644 ouid=0 ogid=0 rdev=00:00
type=CWD msg=audit(1234874638.599:5207): cwd="/root"
type=SYSCALL msg=audit(1234874638.599:5207): arch=c000003e syscall=2 success=yes
exit=4 a0=62fb60 a1=0 a2=31 a3=0 items=1 ppid=25400 pid=25616 auid=0 uid=0 gid=0
euid=0 suid=0 fsuid=0 egid=0 sgid=0 fsgid=0 tty=pts1 ses=1164 comm="less" exe="/
usr/bin/less" key="doc_log"
```

The `ausearch -a` command grabs all records in the logs that are related to the audit event ID provided and displays them. This option can be combined with any other option.

Search by message type

To search for audit records of a particular message type, use the `ausearch -m MESSAGE_TYPE` command. Examples of valid message types include `PATH`, `SYSCALL`, and `USER_LOGIN`. Running `ausearch -m` without a message type displays a list of all message types.

Search by login ID

To view records associated with a particular login user ID, use the `ausearch -ul` command. It displays any records related to the user login ID specified provided that user had been able to log in successfully.

Search by user ID

View records related to any of the user IDs (both user ID and effective user ID) with `ausearch -ua`. View reports related to a particular user ID with `ausearch -ui UID`. Search for records related to a particular effective user ID, use the `ausearch -ue EUID`. Searching for a user ID means the user ID of the user creating a process. Searching for an effective user ID means the user ID and privileges that are required to run this process.

Search by group ID

View records related to any of the group IDs (both group ID and effective group ID) with the `ausearch -ga` command. View reports related to a particular user ID with `ausearch -gi GID`. Search for records related to a particular effective group ID, use `ausearch -ge EGID`.

Search by command line name

View records related to a certain command, using the `ausearch -c COMM_NAME` command, for example, `ausearch -c less` for all records related to the `less` command.

Search by executable name

View records related to a certain executable with the `ausearch -x EXE` command, for example `ausearch -x /usr/bin/less` for all records related to the `/usr/bin/less` executable.

Search by system call name

View records related to a certain system call with the `ausearch -sc SYSCALL` command, for example, `ausearch -sc open` for all records related to the `open` system call.

Search by process ID

View records related to a certain process ID with the `ausearch -p PID` command, for example `ausearch -p 13368` for all records related to this process ID.

Search by event or system call success value

View records containing a certain system call success value with `ausearch -sv SUCCESS_VALUE`, for example, `ausearch -sv yes` for all successful system calls.

Search by file name

View records containing a certain file name with `ausearch -f FILE_NAME`, for example, `ausearch -f /foo/bar` for all records related to the `/foo/bar` file. Using the file name alone would work as well, but using relative paths does not work.

Search by terminal

View records of events related to a certain terminal with `ausearch -tm TERM`, for example, `ausearch -tm ssh` to view all records related to events on the SSH terminal and `ausearch -tm tty` to view all events related to the console.

Search by host name

View records related to a certain remote host name with `ausearch -hn HOSTNAME`, for example, `ausearch -hn jupiter.example.com`. You can use a host name, fully qualified domain name, or numeric network address.

Search by key field

View records that contain a certain key assigned in the audit rule set to identify events of a particular type. Use the `ausearch -k KEY_FIELD`, for example, `ausearch -k CFG_etc` to display any records containing the `CFG_etc` key.

Search by word

View records that contain a certain string assigned in the audit rule set to identify events of a particular type. The whole string is matched on file name, host name, and terminal. Use the `ausearch -w WORD`.

Limit a search to a certain time frame

Use `-ts` and `-te` to limit the scope of your searches to a certain time frame. The `-ts` option is used to specify the start date and time and the `-te` option is used to specify the end date and time. These options can be combined with any of the above. The use of these options is similar to use with `aureport`.

44.7 Analyzing processes with `autrace`

Other than monitoring your system using the rules you set up, you can also perform dedicated audits of individual processes using the `autrace` command. `autrace` works similarly to the `strace` command, but gathers slightly different information. The output of `autrace` is written to `/var/log/audit/audit.log` and does not look any different from the standard audit log entries.

When performing an **autrace** on a process, make sure that any audit rules are purged from the queue to avoid these rules clashing with the ones **autrace** adds itself. Delete the audit rules with the **auditctl -D** command. This stops all normal auditing.

```
> sudo auditctl -D

No rules

autrace /usr/bin/less

Waiting to execute: /usr/bin/less
Cleaning up...
No rules
Trace complete. You can locate the records with 'ausearch -i -p 7642'
```

Always use the full path to the executable to track with **autrace**. After the trace is complete, **autrace** provides the event ID of the trace, so you can analyze the entire data trail with **ausearch**. To restore the audit system to use the audit rule set again, restart the audit daemon with **systemctl restart auditd**.

44.8 Visualizing audit data

Neither the data trail in `/var/log/audit/audit.log` nor the different report types generated by **aureport**, described in [Section 44.5.2, “Generating custom audit reports”](#), provide an intuitive reading experience to the user. The **aureport** output is formatted in columns and thus easily available to any sed, Perl or awk scripts that users might connect to the audit framework to visualize the audit data.

The visualization scripts (see [Section 45.6, “Configuring log visualization”](#)) are one example of how to use standard Linux tools available with SUSE Linux Enterprise Server or any other Linux distribution to create easy-to-read audit output. The following examples help you understand how the plain audit reports can be transformed into human readable graphics.

The first example illustrates the relationship of programs and system calls. To get to this kind of data, you need to determine the appropriate **aureport** command that delivers the source data from which to generate the final graphic:

```
> sudo aureport -s -i

Syscall Report
=====
# date time syscall pid comm auid event
```



```
=====
1. 16/02/09 17:45:01 open 20343 cron unset 2279
2. 16/02/09 17:45:02 mkdir 20350 mktemp root 2284
3. 16/02/09 17:45:02 mkdir 20351 mkdir root 2285
...
```

The first thing that the visualization script needs to do on this report is to extract those columns that are of interest. In this example, they are the `syscall` and the `comm` columns. The output is sorted and duplicates removed; then the final output is written into the visualization program itself:

```
LC_ALL=C aureport -s -i | awk '/^[0-9]/ { print $6" "$4 }' | sort | uniq | mkgraph
```

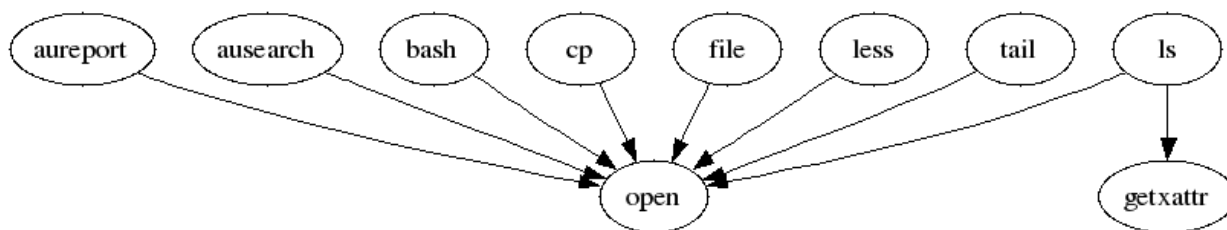

FIGURE 44.2: FLOW GRAPH—PROGRAM VERSUS SYSTEM CALL RELATIONSHIP

The second example illustrates the different types of events and how many of each type have been logged. The appropriate `aureport` command to extract this kind of information is `aureport -e`:

```
> sudo aureport -e -i --summary
```

```
Event Summary Report
=====
total  type
=====
2434  SYSCALL
816   USER_START
816   USER_ACCT
814   CRED_ACQ
810   LOGIN
806   CRED_DISP
779   USER_END
99    CONFIG_CHANGE
52    USER_LOGIN
```

Because this type of report already contains a two-column output, it is fed into the visualization script and transformed into a bar chart.

```
> sudo aureport -e -i --summary | mkbar events
```

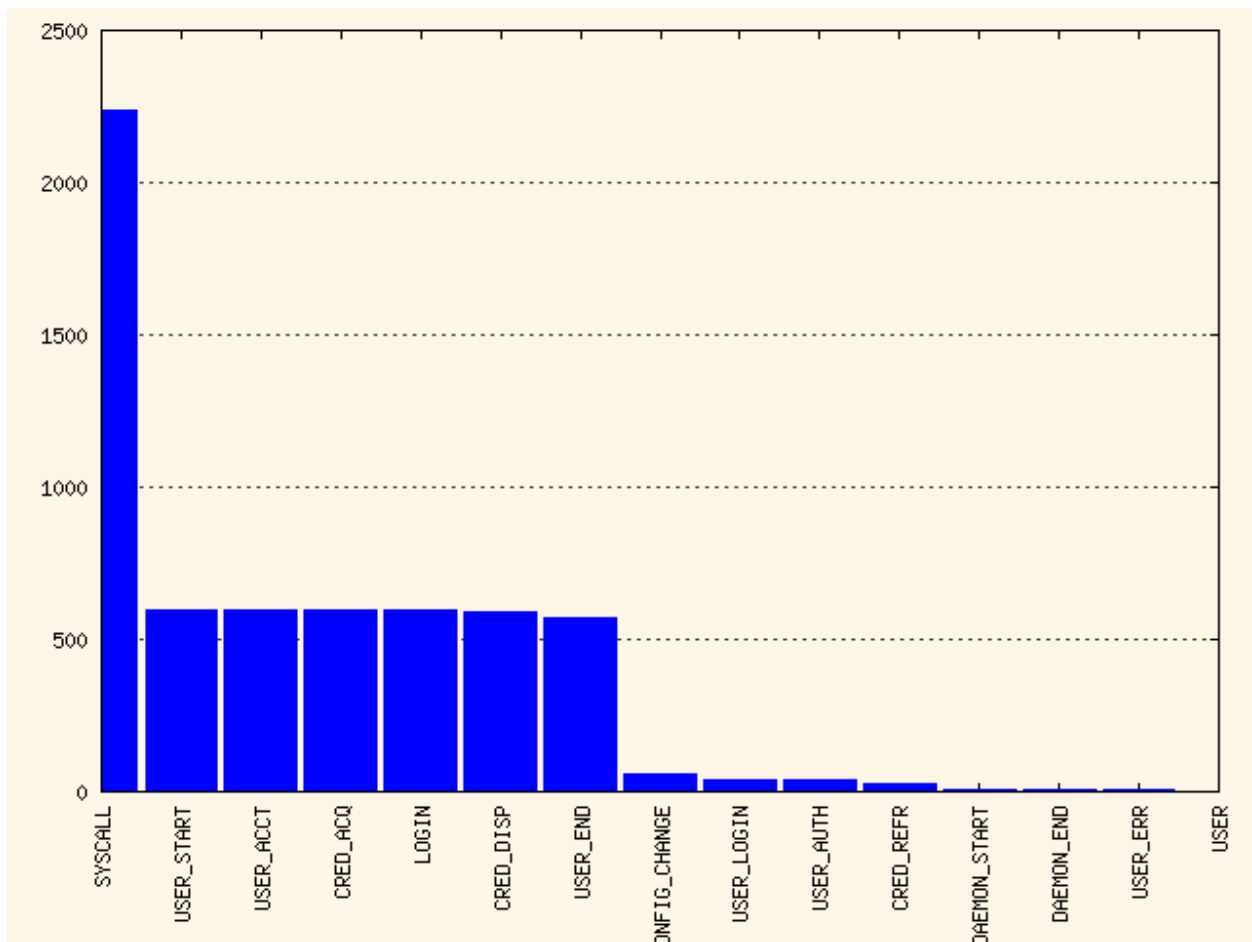

FIGURE 44.3: BAR CHART—COMMON EVENT TYPES

For background information about the visualization of audit data, refer to the Web site of the audit project at <https://people.redhat.com/sgrubb/audit/visualize/index.html>.

44.9 Relaying audit event notifications

The auditing system also allows external applications to access and use the `auditd` daemon in real time. This feature is provided by so called *audit dispatcher* which allows, for example, intrusion detection systems to use `auditd` to receive enhanced detection information.

The configuration of `auditd` is stored in `/etc/audit/auditd.conf`. The file includes the following options:

`q_depth`

Specifies the size of the event dispatcher internal queue. If syslog complains about audit events getting dropped, increase this value. Default is 250.

overflow_action

Specifies the way the audit daemon reacts to the internal queue overflow. Possible values are ignore (nothing happens), syslog (issues a warning to syslog), suspend (stop processing events), single (the computer system is put in single user mode), or halt (shuts the system down).

priority_boost

Specifies the priority for the audit event dispatcher (in addition to the audit daemon priority itself). Default is 4 which means no change in priority.

name_format

Specifies the way the computer node name is inserted into the audit event. Possible values are none (no computer name is inserted), hostname (name returned by the gethostname system call), fqd (fully qualified domain name of the machine), numeric (IP address of the machine), or user (user defined string from the name option). Default is none.

name

Specifies a user-defined string which identifies the machine. The name_format option must be set to user, otherwise this option is ignored.

max_restarts

A non-negative number that tells the audit event dispatcher how many times it can try to restart a crashed plug-in. The default is 10.

EXAMPLE 44.10: [EXAMPLE /ETC/AUDIT/AUDITD.CONF](#)

```
q_depth = 250
overflow_action = SYSLOG
priority_boost = 4
name_format = HOSTNAME
#name = mydomain
```

The plug-in programs install their configuration files in a special directory, /etc/audit/plu-gins.d. The plug-in configuration files have the following options:

active

Specifies if the program uses auditd. Possible values are yes or no.

direction

Specifies the way the plug-in was designed to communicate with audit. It informs the event dispatcher in which directions the events flow. Possible values are in or out.

path

Specifies the absolute path to the plug-in executable. In case of internal plug-ins, this option specifies the plug-in name.

type

Specifies the way the plug-in is to be run. Possible values are builtin or always. Use builtin for internal plug-ins (af_unix and syslog) and always for most (if not all) other plug-ins. Default is always.

args

Specifies the argument that is passed to the plug-in program. Normally, plug-in programs read their arguments from their configuration file and do not need to receive any arguments. There is a limit of two arguments.

format

Specifies the format of data that the audit dispatcher passes to the plug-in program. Valid options are binary or string. binary passes the data exactly as the event dispatcher receives them from the audit daemon. string instructs the dispatcher to change the event into a string that is parsable by the audit parsing library. Default is string.

EXAMPLE 44.11: [EXAMPLE /ETC/AUDIT/PLUGINS.D/SYSLOG.CONF](#)

```
active = no
direction = out
path = /sbin/audisp-syslog
type = always
args = LOG_INFO
format = string
```

45 Setting up the Linux audit framework

This chapter shows how to set up a simple audit scenario. Every step involved in configuring and enabling audit is explained in detail. After you have learned to set up audit, consider a real-world example scenario in [Chapter 46, Introducing an audit rule set](#).

To set up audit on SUSE Linux Enterprise Server, you need to complete the following steps:

PROCEDURE 45.1: SETTING UP THE LINUX AUDIT FRAMEWORK

1. Install the `audit` package. To use the log visualization as described in [Section 45.6, “Configuring log visualization”](#), install `gnuplot` and `graphviz`.
2. Determine the components to audit. Refer to [Section 45.1, “Determining the components to audit”](#) for details.
3. Check or modify the basic audit daemon configuration. Refer to [Section 45.2, “Configuring the audit daemon”](#) for details.
4. Enable auditing for system calls. Refer to [Section 45.3, “Enabling audit for system calls”](#) for details.
5. Compose audit rules to suit your scenario. Refer to [Section 45.4, “Setting up audit rules”](#) for details.
6. Generate logs and configure tailor-made reports. Refer to [Section 45.5, “Configuring audit reports”](#) for details.
7. Configure optional log visualization. Refer to [Section 45.6, “Configuring log visualization”](#) for details.



Important: Controlling the audit daemon

Before configuring any of the components of the audit system, make sure that the audit daemon is not running by entering `systemctl status auditd` as `root`. On a default SUSE Linux Enterprise Server system, audit is started on boot, so you need to turn it off by entering `systemctl stop auditd`. Start the daemon after configuring it with `systemctl start auditd`.

45.1 Determining the components to audit

Before starting to create your own audit configuration, determine to which degree you want to use it. Check the following general rules to determine which use case best applies to you and your requirements:

- If you require a full security audit for CAPP/EAL certification, enable full audit for system calls and configure watches on various configuration files and directories, similar to the rule set featured in *Chapter 46, Introducing an audit rule set*.
- If you need to trace a process based on the audit rules, use **autrace**.
- If you require file and directory watches to track access to important or security-sensitive data, create a rule set matching these requirements. Enable audit as described in *Section 45.3, "Enabling audit for system calls"* and proceed to *Section 45.4, "Setting up audit rules"*.

45.2 Configuring the audit daemon

The basic setup of the audit daemon is done by editing `/etc/audit/auditd.conf`. You may also use YaST to configure the basic settings by calling *YaST > Security and Users > Linux Audit Framework (LAF)*. Use the tabs *Log File* and *Disk Space* for configuration.

```

log_file = /var/log/audit/audit.log
log_format = RAW
log_group = root
priority_boost = 4
flush = INCREMENTAL
freq = 20
num_logs = 5
disp_qos = lossy
dispatcher = /sbin/audispd
name_format = NONE
##name = mydomain
max_log_file = 6
max_log_file_action = ROTATE
space_left = 75
space_left_action = SYSLOG
action_mail_acct = root
admin_space_left = 50
admin_space_left_action = SUSPEND
disk_full_action = SUSPEND
disk_error_action = SUSPEND
##tcp_listen_port =
tcp_listen_queue = 5
tcp_max_per_addr = 1
##tcp_client_ports = 1024-65535
tcp_client_max_idle = 0
cp_client_max_idle = 0

```

The default settings work reasonably well for many setups. Some values, such as `num_logs`, `max_log_file`, `space_left`, and `admin_space_left` depend on the size of your deployment. If disk space is limited, you should reduce the number of log files to keep if they are rotated and you should get an earlier warning if disk space is running out. For a CAPP-compliant setup, adjust the values for `log_file`, `flush`, `max_log_file`, `max_log_file_action`, `space_left`, `space_left_action`, `admin_space_left`, `admin_space_left_action`, `disk_full_action`, and `disk_error_action`, as described in [Section 44.2, “Configuring the audit daemon”](#). An example CAPP-compliant configuration looks like this:

```

log_file = PATH_TO_SEPARATE_PARTITION/audit.log
log_format = RAW
priority_boost = 4
flush = SYNC                ### or DATA
freq = 20
num_logs = 4
dispatcher = /sbin/audispd
disp_qos = lossy
max_log_file = 5

```

```
max_log_file_action = KEEP_LOGS
space_left = 75
space_left_action = EMAIL
action_mail_acct = root
admin_space_left = 50
admin_space_left_action = SINGLE   ### or HALT
disk_full_action = SUSPEND        ### or HALT
disk_error_action = SUSPEND       ### or HALT
```

The `###` precedes comments where you can choose from several options. Do not add the comments to your actual configuration files.



Tip: More information

Refer to [Section 44.2, “Configuring the audit daemon”](#) for detailed background information about the `auditd.conf` configuration parameters.

45.3 Enabling audit for system calls

If the audit framework is not installed, install the `audit` package. A standard SUSE Linux Enterprise Server system does not have `auditd` running by default. Enable it with:

```
> sudo systemctl enable auditd
```

There are different levels of auditing activity available:

Basic logging

Out of the box (without any further configuration) `auditd` logs only events concerning its own configuration changes to `/var/log/audit/audit.log`. No events (file access, system call, etc.) are generated by the kernel audit component until requested by `auditctl`. However, other kernel components and modules may log audit events outside of the control of `auditctl` and these appear in the audit log. By default, the only module that generates audit events is AppArmor.

Advanced logging with system call auditing

To audit system calls and get meaningful file watches, you need to enable audit contexts for system calls.

As you need system call auditing capabilities even when you are configuring plain file or directory watches, you need to enable audit contexts for system calls. To enable audit contexts for the duration of the current session, execute `auditctl -e 1` as `root`. To disable this feature, execute `auditctl -e 0` as `root`.

The audit contexts are enabled by default. To turn this feature off temporarily, use `auditctl -e 0`.

45.4 Setting up audit rules

Using audit rules, determine which aspects of the system should be analyzed by audit. Normally this includes important databases and security-relevant configuration files. You may also analyze various system calls in detail if a broad analysis of your system is required. A detailed example configuration that includes most of the rules that are needed in a CAPP compliant environment is available in *Chapter 46, Introducing an audit rule set*.

Audit rules can be passed to the audit daemon on the `auditctl` command line and by composing a rule set in `/etc/audit/audit.rules` which is processed whenever the audit daemon is started. To customize `/etc/audit/audit.rules` either edit it directly, or use YaST: *Security and Users > Linux Audit Framework (LAF) > Rules for 'auditctl'*. Rules passed on the command line are not persistent and need to be re-entered when the audit daemon is restarted.

A simple rule set for basic auditing on a few important files and directories could look like this:

```
# basic audit system parameters
-D
-b 8192
-f 1
-e 1

# some file and directory watches with keys
-w /var/log/audit/ -k LOG_audit
-w /etc/audit/auditd.conf -k CFG_audit_conf -p rxwa
-w /etc/audit/audit.rules -k CFG_audit_rules -p rxwa

-w /etc/passwd -k CFG_passwd -p rwx
-w /etc/sysconfig/ -k CFG_sysconfig

# an example system call rule
-a entry,always -S umask

### add your own rules
```

When configuring the basic audit system parameters (such as the backlog parameter `-b`) test these settings with your intended audit rule set to determine whether the backlog size is appropriate for the level of logging activity caused by your audit rule set. If your chosen backlog size is too small, your system might not be able to handle the audit load and consult the failure flag (`-f`) when the backlog limit is exceeded.

Important: Choosing the failure flag

When choosing the failure flag, `-f 2` tells your system to perform an immediate shutdown without flushing any pending data to disk when the limits of your audit system are exceeded. Because this shutdown is not a clean shutdown, restrict the use of `-f 2` to the most security-conscious environments and use `-f 1` (system continues to run, issues a warning and audit stops) for any other setup to avoid loss of data or data corruption.

Directory watches produce less verbose output than separate file watches for the files under these directories. To get detailed logging for your system configuration in `/etc/sysconfig`, for example, add watches for each file. Audit does not support globbing, which means you cannot create a rule that says `-w /etc/*` and watches all files and directories below `/etc`.

For better identification in the log file, a key has been added to each of the file and directory watches. Using the key, it is easier to comb the logs for events related to a certain rule. When creating keys, distinguish between mere log file watches and configuration file watches by using an appropriate prefix with the key, in this case `LOG` for a log file watch and `CFG` for a configuration file watch. Using the file name as part of the key also makes it easier for you to identify events of this type in the log file.

Another thing to keep in mind when creating file and directory watches is that audit cannot deal with files that do not exist when the rules are created. Any file that is added to your system while audit is already running is not watched unless you extend the rule set to watch this new file.

For more information about creating custom rules, refer to [Section 44.4, "Passing parameters to the audit system"](#).

Important: Changing audit rules

After you change audit rules, always restart the audit daemon with `systemctl restart auditd` to reread the changed rules.

45.5 Configuring audit reports

To avoid having to dig through the raw audit logs to get an impression of what your system is currently doing, run custom audit reports at certain intervals. Custom audit reports enable you to focus on areas of interest and get meaningful statistics on the nature and frequency of the events you are monitoring. To analyze individual events in detail, use the ausearch tool.

Before setting up audit reporting, consider the following:

- What types of events do you want to monitor by generating regular reports? Select the appropriate aureport command lines as described in [Section 44.5.2, “Generating custom audit reports”](#).
- What do you want to do with the audit reports? Decide whether to create graphical charts from the data accumulated or whether it should be transferred into any sort of spreadsheet or database. Set up the aureport command line and further processing similar to the examples shown in [Section 45.6, “Configuring log visualization”](#) to visualize your reports.
- When and at which intervals should the reports run? Set up appropriate automated reporting using cron.

For this example, assume that you are interested in finding out about any attempts to access your audit, PAM and system configuration. Proceed as follows to find out about file events on your system:

1. Generate a full summary report of all events and check for any anomalies in the summary report, for example, have a look at the “failed syscalls” record, because these might have failed because of insufficient permissions to access a file or a file not being there:

```
> sudo aureport

Summary Report
=====
Range of time in logs: 03/02/09 14:13:38.225 - 17/02/09 16:30:10.352
Selected time for report: 03/02/09 14:13:38 - 17/02/09 16:30:10.352
Number of changes in configuration: 24
Number of changes to accounts, groups, or roles: 0
Number of logins: 9
Number of failed logins: 15
Number of authentications: 19
Number of failed authentications: 578
Number of users: 3
Number of terminals: 15
Number of host names: 4
Number of executables: 20
Number of files: 279
Number of AVC's: 0
Number of MAC events: 0
Number of failed syscalls: 994
Number of anomaly events: 0
Number of responses to anomaly events: 0
Number of crypto events: 0
Number of keys: 2
Number of process IDs: 1238
Number of events: 5435
```

2. Run a summary report for failed events and check the “files” record for the number of failed file access events:

```
> sudo aureport --failed

Failed Summary Report
=====
Range of time in logs: 03/02/09 14:13:38.225 - 17/02/09 16:30:10.352
Selected time for report: 03/02/09 14:13:38 - 17/02/09 16:30:10.352
Number of changes in configuration: 0
```

```
Number of changes to accounts, groups, or roles: 0
Number of logins: 0
Number of failed logins: 15
Number of authentications: 0
Number of failed authentications: 578
Number of users: 1
Number of terminals: 7
Number of host names: 4
Number of executables: 12
Number of files: 77
Number of AVC's: 0
Number of MAC events: 0
Number of failed syscalls: 994
Number of anomaly events: 0
Number of responses to anomaly events: 0
Number of crypto events: 0
Number of keys: 2
Number of process IDs: 713
Number of events: 1589
```

3. To list the files that could not be accessed, run a summary report of failed file events:

```
> sudo aureport -f -i --failed --summary

Failed File Summary Report
=====
total  file
=====
80  /var
80  spool
80  cron
80  lastrun
46  /usr/lib/locale/en_GB.UTF-8/LC_CTYPE
45  /usr/lib/locale/locale-archive
38  /usr/lib/locale/en_GB.UTF-8/LC_IDENTIFICATION
38  /usr/lib/locale/en_GB.UTF-8/LC_MEASUREMENT
38  /usr/lib/locale/en_GB.UTF-8/LC_TELEPHONE
38  /usr/lib/locale/en_GB.UTF-8/LC_ADDRESS
38  /usr/lib/locale/en_GB.UTF-8/LC_NAME
38  /usr/lib/locale/en_GB.UTF-8/LC_PAPER
38  /usr/lib/locale/en_GB.UTF-8/LC_MESSAGES
38  /usr/lib/locale/en_GB.UTF-8/LC_MONETARY
38  /usr/lib/locale/en_GB.UTF-8/LC_COLLATE
38  /usr/lib/locale/en_GB.UTF-8/LC_TIME
38  /usr/lib/locale/en_GB.UTF-8/LC_NUMERIC
8   /etc/magic.mgc
...

```

To focus this summary report on a few files or directories of interest, such as `/etc/audit/auditd.conf`, `/etc/pam.d`, and `/etc/sysconfig`, use a command similar to the following:

```
> sudo aureport -f -i --failed --summary |grep -e "/etc/audit/auditd.conf" -e "/etc/pam.d/" -e "/etc/sysconfig"
```

```
1 /etc/sysconfig/displaymanager
```

4. From the summary report, then proceed to isolate these items of interest from the log and find out their event IDs for further analysis:

```
> sudo aureport -f -i --failed |grep -e "/etc/audit/auditd.conf" -e "/etc/pam.d/" -e "/etc/sysconfig"
```

```
993. 17/02/09 16:47:34 /etc/sysconfig/displaymanager readlink no /bin/vim-normal
root 7887
994. 17/02/09 16:48:23 /etc/sysconfig/displaymanager getxattr no /bin/vim-normal
root 7889
```

5. Use the event ID to get a detailed record for each item of interest:

```
> sudo ausearch -a 7887 -i
```

```
----
```

```
time->Tue Feb 17 16:48:23 2009
```

```
type=PATH msg=audit(1234885703.090:7889): item=0 name="/etc/sysconfig/
displaymanager" inode=369282 dev=08:06 mode=0100644 ouid=0 ogid=0 rdev=00:00
```

```
type=CWD msg=audit(1234885703.090:7889): cwd="/root"
```

```
type=SYSCALL msg=audit(1234885703.090:7889): arch=c000003e syscall=191 success=no
exit=-61 a0=7e1e20 a1=7f90e4cf9187 a2=7fffed5b57d0 a3=84 items=1 ppid=25548
```

```
pid=23045 auid=0 uid=0 gid=0 euid=0 suid=0 fsuid=0 egid=0 sgid=0 fsgid=0 tty=pts2
ses=1166 comm="vim" exe="/bin/vim-normal" key=(null)
```



Tip: Focusing on a certain time frame

If you are interested in events during a particular period of time, trim down the reports by using start and end dates and times with your **aureport** commands (`-ts` and `-te`). For more information, refer to [Section 44.5.2, "Generating custom audit reports"](#).

All steps (except for the last one) can be run automatically and would easily be scriptable and configured as cron jobs. Any of the `--failed --summary` reports could be transformed easily into a bar chart that plots files versus failed access attempts. For more information about visualizing audit report data, refer to [Section 45.6, “Configuring log visualization”](#).

45.6 Configuring log visualization

Using the scripts `mkbar` and `mkgraph` you can illustrate your audit statistics with various graphs and charts. As with any other `aureport` command, the plotting commands are scriptable and can easily be configured to run as cron jobs.

`mkbar` and `mkgraph` were created by Steve Grubb at Red Hat. They are available from <https://people.redhat.com/sgrubb/audit/visualize/>. Because the current version of audit in SUSE Linux Enterprise Server does not ship with these scripts, proceed as follows to make them available on your system:



Warning: Downloaded content is dangerous

Use `mkbar` and `mkgraph` at your own risk. Any content downloaded from the Web is potentially dangerous to your system, even more so when run with `root` privileges.

1. Download the scripts to `root`'s `~/bin` directory:

```
> sudo wget http://people.redhat.com/sgrubb/audit/visualize/mkbar -O ~/bin/mkbar
> sudo wget http://people.redhat.com/sgrubb/audit/visualize/mkgraph -O ~/bin/mkgraph
```

2. Adjust the file permissions to read, write, and execute for `root`:

```
> sudo chmod 744 ~/bin/mk{bar,graph}
```

To plot summary reports, such as the ones discussed in [Section 45.5, “Configuring audit reports”](#), use the script `mkbar`. Some example commands could look like the following:

Create a summary of events

```
> sudo aureport -e -i --summary | mkbar events
```

Create a summary of file events

```
> sudo aureport -f -i --summary | mkbar files
```

Create a summary of login events

```
> sudo aureport -l -i --summary | mkbar login
```

Create a summary of user events

```
> sudo aureport -u -i --summary | mkbar users
```

Create a summary of system call events

```
> sudo aureport -s -i --summary | mkbar syscalls
```

To create a summary chart of failed events of any of the above event types, add the `--failed` option to the respective `aureport` command. To cover a certain period of time, use the `-ts` and `-te` options on `aureport`. Any of these commands can be tweaked further by narrowing down its scope using `grep` or `egrep` and regular expressions. See the comments in the `mkbar` script for an example. Any of the above commands produces a PNG file containing a bar chart of the requested data.

To illustrate the relationship between different kinds of audit objects, such as users and system calls, use the script `mkgraph`. Some example commands could look like the following:

Users versus executables

```
> sudo LC_ALL=C aureport -u -i | awk '/^[0-9]/ { print $4" "$7 }' | sort | uniq |  
mkgraph users_vs_exec
```

Users versus files

```
> sudo LC_ALL=C aureport -f -i | awk '/^[0-9]/ { print $8" "$4 }' | sort | uniq |  
mkgraph users_vs_files
```

System calls versus commands

```
> sudo LC_ALL=C aureport -s -i | awk '/^[0-9]/ { print $4" "$6 }' | sort | uniq |  
mkgraph syscall_vs_com
```

System calls versus files

```
> sudo LC_ALL=C aureport -s -i | awk '/^[0-9]/ { print $5" "$4 }' | sort | uniq |  
mkgraph | syscall_vs_file
```

Graphs can also be combined to illustrate complex relationships. See the comments in the `mkgraph` script for further information and an example. The graphs produced by this script are created in PostScript format by default, but you can change the output format by changing the `EXT` variable in the script from `ps` to `png` or `jpg`.

46 Introducing an audit rule set

The following example configuration illustrates how audit can be used to monitor your system. It highlights the most important items that need to be audited to cover the list of auditable events specified by Controlled Access Protection Profile (CAPP).

The example rule set is divided into the following sections:

- Basic audit configuration (see [Section 46.1, “Adding basic audit configuration parameters”](#))
- Watches on audit log files and configuration files (see [Section 46.2, “Adding watches on audit log files and configuration files”](#))
- Monitoring operations on file system objects (see [Section 46.3, “Monitoring file system objects”](#))
- Monitoring security databases (see [Section 46.4, “Monitoring security configuration files and databases”](#))
- Monitoring miscellaneous system calls ([Section 46.5, “Monitoring miscellaneous system calls”](#))
- Filtering system call arguments (see [Section 46.6, “Filtering system call arguments”](#))

To transform this example into a configuration file to use in your live setup, proceed as follows:

1. Choose the appropriate settings for your setup and adjust them.
2. Adjust the file `/etc/audit/audit.rules` by adding rules from the examples below or by modifying existing rules.



Note: Adjusting the level of audit logging

Do not copy the example below into your audit setup without adjusting it to your needs. Determine what and to what extent to audit.

The entire `audit.rules` is a collection of `auditctl` commands. Every line in this file expands to a full `auditctl` command line. The syntax used in the rule set is the same as that of the `auditctl` command.

46.1 Adding basic audit configuration parameters

```
-D ❶  
-b 8192 ❷  
-f 2 ❸
```

- ❶ Delete any preexisting rules before starting to define new ones.
- ❷ Set the number of buffers to take the audit messages. Depending on the level of audit logging on your system, increase or decrease this figure.
- ❸ Set the failure flag to use when the kernel needs to handle critical errors. Possible values are 0 (silent), 1 (printk, print a failure message), and 2 (panic, halt the system).

By emptying the rule queue with the `-D` option, you make sure that audit does not use any other rule set than what you are offering it via this file. Choosing an appropriate buffer number (`-b`) is vital to avoid having your system fail because of too high an audit load. Choosing the panic failure flag `-f 2` ensures that your audit records are complete even if the system is encountering critical errors. By shutting down the system on a critical error, audit makes sure that no process escapes from its control as it otherwise might if level 1 (`printk`) were chosen.

! Important: Choosing the failure flag

Before using your audit rule set on a live system, make sure that the setup has been thoroughly evaluated on test systems using the *worst case production workload*. It is even more critical that you do this when specifying the `-f 2` flag, because this instructs the kernel to panic (perform an immediate halt without flushing pending data to disk) if any thresholds are exceeded. Consider the use of the `-f 2` flag for only the most security-conscious environments.

46.2 Adding watches on audit log files and configuration files

Adding watches on your audit configuration files and the log files themselves ensures that you can track any attempt to tamper with the configuration files or detect any attempted accesses to the log files.



Note: Creating directory and file watches

Creating watches on a directory is not necessarily sufficient if you need events for file access. Events on directory access are only triggered when the directory's inode is updated with metadata changes. To trigger events on file access, add watches for each file to monitor.

```
-w /var/log/audit/ ❶  
-w /var/log/audit/audit.log  
  
-w /var/log/audit/audit_log.1  
-w /var/log/audit/audit_log.2  
-w /var/log/audit/audit_log.3  
-w /var/log/audit/audit_log.4  
  
-w /etc/audit/auditd.conf -p wa ❷  
-w /etc/audit/audit.rules -p wa  
-w /etc/libaudit.conf -p wa
```

- ❶ Set a watch on the directory where the audit log is located. Trigger an event for any type of access attempt to this directory. If you are using log rotation, add watches for the rotated logs as well.
- ❷ Set a watch on an audit configuration file. Log all write and attribute change attempts to this file.

46.3 Monitoring file system objects

Auditing system calls helps track your system's activity well beyond the application level. By tracking file system–related system calls, get an idea of how your applications are using these system calls and determine whether that use is appropriate. By tracking mount and unmount operations, track the use of external resources (removable media, remote file systems, etc.).

! Important: Auditing system calls

Auditing system calls results in a high logging activity. This activity, in turn, puts a heavy load on the kernel. With a kernel less responsive than usual, the system's backlog and rate limits might be exceeded. Carefully evaluate which system calls to include in your audit rule set and adjust the log settings accordingly. See [Section 44.2, “Configuring the audit daemon”](#) for details on how to tweak the relevant settings.

```
-a entry,always -S chmod -S fchmod -S chown -S chown32 -S fchown -S fchown32 -S lchown -S  
lchown32 ❶  
  
-a entry,always -S creat -S open -S truncate -S truncate64 -S ftruncate -S ftruncate64 ❷  
  
-a entry,always -S mkdir -S rmdir ❸  
  
-a entry,always -S unlink -S rename -S link -S symlink ❹  
  
-a entry,always -S setxattr ❺  
-a entry,always -S lsetxattr  
-a entry,always -S fsetxattr  
-a entry,always -S removexattr  
-a entry,always -S lremovexattr  
-a entry,always -S fremovexattr  
  
-a entry,always -S mknod ❻  
  
-a entry,always -S mount -S umount -S umount2 ❼
```

- ❶ Enable an audit context for system calls related to changing file ownership and permissions. Depending on the hardware architecture of your system, enable or disable the `*32` rules. 64-bit systems, like AMD64/Intel 64, require the `*32` rules to be removed.
- ❷ Enable an audit context for system calls related to file content modification. Depending on the hardware architecture of your system, enable or disable the `*64` rules. 64-bit systems, like AMD64/Intel 64, require the `*64` rules to be removed.
- ❸ Enable an audit context for any directory operation, like creating or removing a directory.
- ❹ Enable an audit context for any linking operation, such as creating a symbolic link, creating a link, unlinking, or renaming.
- ❺ Enable an audit context for any operation related to extended file system attributes.
- ❻ Enable an audit context for the `mknod` system call, which creates special (device) files.

- 7 Enable an audit context for any mount or umount operation. For the x86 architecture, disable the `umount` rule. For the Intel 64 architecture, disable the `umount2` rule.

46.4 Monitoring security configuration files and databases

To make sure that your system is not made to do undesired things, track any attempts to change the `cron` and `at` configurations or the lists of scheduled jobs. Tracking any write access to the user, group, password and login databases and logs helps you identify any attempts to manipulate your system's user database.

Tracking changes to your system configuration (kernel, services, time, etc.) helps you spot any attempts of others to manipulate essential functionality of your system. Changes to the PAM configuration should also be monitored in a secure environment, because changes in the authentication stack should not be made by anyone other than the administrator, and it should be logged which applications are using PAM and how it is used. The same applies to any other configuration files related to secure authentication and communication.

1

```
-w /var/spool/atspool
-w /etc/at.allow
-w /etc/at.deny

-w /etc/cron.allow -p wa
-w /etc/cron.deny -p wa
-w /etc/cron.d/ -p wa
-w /etc/cron.daily/ -p wa
-w /etc/cron.hourly/ -p wa
-w /etc/cron.monthly/ -p wa
-w /etc/cron.weekly/ -p wa
-w /etc/crontab -p wa
-w /var/spool/cron/root
```

2

```
-w /etc/group -p wa
-w /etc/passwd -p wa
-w /etc/shadow

-w /etc/login.defs -p wa
-w /etc/securetty
-w /var/log/lastlog
```

```

3
-w /etc/hosts -p wa
-w /etc/sysconfig/
w /etc/init.d/
w /etc/ld.so.conf -p wa
w /etc/localtime -p wa
w /etc/sysctl.conf -p wa
w /etc/modprobe.d/
w /etc/modprobe.conf.local -p wa
w /etc/modprobe.conf -p wa
4
w /etc/pam.d/
5
-w /etc/aliases -p wa
-w /etc/postfix/ -p wa

6
-w /etc/ssh/sshd_config

-w /etc/stunnel/stunnel.conf
-w /etc/stunnel/stunnel.pem

-w /etc/vsftpd.ftpusers
-w /etc/vsftpd.conf

7
-a exit,always -S sethostname
-w /etc/issue -p wa
-w /etc/issue.net -p wa

```

- ❶ Set watches on the `at` and `cron` configuration and the scheduled jobs and assign labels to these events.
- ❷ Set watches on the user, group, password, and login databases and logs and set labels to better identify any login-related events, such as failed login attempts.
- ❸ Set a watch and a label on the static host name configuration in `/etc/hosts`. Track changes to the system configuration directory, `/etc/sysconfig`. Enable per-file watches if you are interested in file events. Set watches and labels for changes to the boot configuration in the `/etc/init.d` directory. Enable per-file watches if you are interested in file events. Set watches and labels for any changes to the linker configuration in `/etc/ld.so.conf`. Set watches and a label for `/etc/localtime`. Set watches and labels for the kernel configuration files `/etc/sysctl.conf`, `/etc/modprobe.d/`, `/etc/modprobe.conf.local`, and `/etc/modprobe.conf`.

- ④ Set watches on the PAM configuration directory. If you are interested in particular files below the directory level, add explicit watches to these files as well.
- ⑤ Set watches to the postfix configuration to log any write attempt or attribute change and use labels for better tracking in the logs.
- ⑥ Set watches and labels on the SSH, `stunnel`, and `vsftpd` configuration files.
- ⑦ Perform an audit of the `sethostname` system call and set watches and labels on the system identification configuration in `/etc/issue` and `/etc/issue.net`.

46.5 Monitoring miscellaneous system calls

Apart from auditing file system related system calls, as described in [Section 46.3, “Monitoring file system objects”](#), you can also track various other system calls. Tracking task creation helps you understand your applications' behavior. Auditing the `umask` system call lets you track how processes modify creation mask. Tracking any attempts to change the system time helps you identify anyone or any process trying to manipulate the system time.

```
①  
-a entry,always -S clone -S fork -S vfork  
  
②  
-a entry,always -S umask  
  
③  
-a entry,always -S adjtimex -S settimeofday
```

- ① Track task creation.
- ② Add an audit context to the `umask` system call.
- ③ Track attempts to change the system time. `adjtimex` can be used to skew the time. `settimeofday` sets the absolute time.

46.6 Filtering system call arguments

In addition to the system call auditing introduced in [Section 46.3, “Monitoring file system objects”](#) and [Section 46.5, “Monitoring miscellaneous system calls”](#), you can track application behavior to an even higher degree. Applying filters helps you focus audit on areas of primary interest to you. This section introduces filtering system call arguments for non-multiplexed system calls like

access and for multiplexed ones like `socketcall` or `ipc`. Whether system calls are multiplexed depends on the hardware architecture used. Both `socketcall` and `ipc` are not multiplexed on 64-bit architectures, such as AMD64/Intel 64.

! Important: Auditing system calls

Auditing system calls results in high logging activity, which in turn puts a heavy load on the kernel. With a kernel less responsive than usual, the system's backlog and rate limits might well be exceeded. Carefully evaluate which system calls to include in your audit rule set and adjust the log settings accordingly. See [Section 44.2, “Configuring the audit daemon”](#) for details on how to tweak the relevant settings.

The `access` system call checks whether a process would be allowed to read, write or test for the existence of a file or file system object. Using the `-F` filter flag, build rules matching specific access calls in the format `-F a1=ACCESS_MODE`. Check `/usr/include/fcntl.h` for a list of possible arguments to the `access` system call.

```
-a entry,always -S access -F a1=4 ❶  
-a entry,always -S access -F a1=6 ❷  
-a entry,always -S access -F a1=7 ❸
```

- ❶ Audit the `access` system call, but only if the second argument of the system call (`mode`) is `4` (`R_OK`). This rule filters for all access calls testing for sufficient read permissions to a file or file system object accessed by a user or process.
- ❷ Audit the `access` system call, but only if the second argument of the system call (`mode`) is `6`, meaning `4 OR 2`, which translates to `R_OK OR W_OK`. This rule filters for access calls testing for sufficient read and write permissions.
- ❸ Audit the `access` system call, but only if the second argument of the system call (`mode`) is `7`, meaning `4 OR 2 OR 1`, which translates to `R_OK OR W_OK OR X_OK`. This rule filters for access calls testing for sufficient read, write, and execute permissions.

The `socketcall` system call is a multiplexed system call. Multiplexed means that there is only one system call for all possible calls and that `libc` passes the actual system call to use as the first argument (`a0`). Check the manual page of `socketcall` for possible system calls and refer to `/usr/src/linux/include/linux/net.h` for a list of possible argument values and system call names. Audit supports filtering for specific system calls using a `-F a0=SYSCALL_NUMBER`.

```

-a entry,always -S socketcall -F a0=1 -F a1=10 ❶
## Use this line on x86_64, ia64 instead
#-a entry,always -S socket -F a0=10

-a entry,always -S socketcall -F a0=5 ❷
## Use this line on x86_64, ia64 instead
#-a entry, always -S accept

```

- ❶ Audit the `socket(PF_INET6)` system call. The `-F a0=1` filter matches all socket system calls and the `-F a1=10` filter narrows the matches down to socket system calls carrying the IPv6 protocol family domain parameter (`PF_INET6`). Check `/usr/include/linux/net.h` for the first argument (`a0`) and `/usr/src/linux/include/linux/socket.h` for the second parameter (`a1`). 64-bit platforms, like AMD64/Intel 64, do not use multiplexing on `socketcall` system calls. For these platforms, comment the rule and add the plain system call rules with a filter on `PF_INET6`.
- ❷ Audit the `socketcall` system call. The filter flag is set to filter for `a0=5` as the first argument to `socketcall`, which translates to the `accept` system call if you check `/usr/include/linux/net.h`. 64-bit platforms, like AMD64/Intel 64, do not use multiplexing on `socketcall` system calls. For these platforms, comment the rule and add the plain system call rule without argument filtering.

The `ipc` system call is another example of multiplexed system calls. The actual call to invoke is determined by the first argument passed to the `ipc` system call. Filtering for these arguments helps you focus on those IPC calls of interest to you. Check `/usr/include/linux/ipc.h` for possible argument values.

```

❶
## msgctl
-a entry,always -S ipc -F a0=14
## msgget
-a entry,always -S ipc -F a0=13
## Use these lines on x86_64, ia64 instead
#-a entry,always -S msgctl
#-a entry,always -S msgget

❷
## semctl
-a entry,always -S ipc -F a0=3
## semget
-a entry,always -S ipc -F a0=2
## semop
-a entry,always -S ipc -F a0=1
## semtimedop

```

```
-a entry,always -S ipc -F a0=4
## Use these lines on x86_64, ia64 instead
#-a entry,always -S semctl
#-a entry,always -S semget
#-a entry,always -S semop
#-a entry,always -S semtimedop
```

③

```
## shmctl
-a entry,always -S ipc -F a0=24
## shmget
-a entry,always -S ipc -F a0=23
## Use these lines on x86_64, ia64 instead
#-a entry,always -S shmctl
#-a entry,always -S shmget
```

- ① Audit system calls related to IPC SYSV message queues. In this case, the `a0` values specify that auditing is added for the `msgctl` and `msgget` system calls (`14` and `13`). 64-bit platforms, like AMD64/Intel 64, do not use multiplexing on `ipc` system calls. For these platforms, comment the first two rules and add the plain system call rules without argument filtering.
- ② Audit system calls related to IPC SYSV message semaphores. In this case, the `a0` values specify that auditing is added for the `semctl`, `semget`, `semop`, and `semtimedop` system calls (`3`, `2`, `1`, and `4`). 64-bit platforms, like AMD64/Intel 64, do not use multiplexing on `ipc` system calls. For these platforms, comment the first four rules and add the plain system call rules without argument filtering.
- ③ Audit system calls related to IPC SYSV shared memory. In this case, the `a0` values specify that auditing is added for the `shmctl` and `shmget` system calls (`24`, `23`). 64-bit platforms, like AMD64/Intel 64, do not use multiplexing on `ipc` system calls. For these platforms, comment the first two rules and add the plain system call rules without argument filtering.

46.7 Managing audit event records using keys

After configuring a few rules generating events and populating the logs, you need to find a way to tell one event from the other. Using the `ausearch` command, you can filter the logs for various criteria. Using `ausearch -m MESSAGE_TYPE`, you can at least filter for events of a certain type. To be able to filter for events related to a particular rule, you need to add a key to this rule in the `/etc/audit/audit.rules` file. This key is then added to the event record every time the rule logs an event. To retrieve these log entries, simply run `ausearch -k YOUR_KEY` to get a list of records related to the rule carrying this particular key.

As an example, assume you have added the following rule to your rule file:

```
-w /etc/audit/audit.rules -p wa
```

Without a key assigned to it, you would need to filter for `SYSCALL` or `PATH` events then use `grep` or similar tools to isolate any events related to the above rule. Now, add a key to the above rule, using the `-k` option:

```
-w /etc/audit/audit.rules -p wa -k CFG_audit.rules
```

You can specify any text string as key. Distinguish watches related to different types of files (configuration files or log files) from one another using different key prefixes (`CFG`, `LOG`, etc.) followed by the file name. Finding any records related to the above rule now comes down to the following:

```
ausearch -k CFG_audit.rules
----
time->Thu Feb 19 09:09:54 2009
type=PATH msg=audit(1235030994.032:8649): item=3 name="audit.rules~" inode=370603
 dev=08:06 mode=0100640 ouid=0 ogid=0 rdev=00:00
type=PATH msg=audit(1235030994.032:8649): item=2 name="audit.rules" inode=370603
 dev=08:06 mode=0100640 ouid=0 ogid=0 rdev=00:00
type=PATH msg=audit(1235030994.032:8649): item=1 name="/etc/audit" inode=368599
 dev=08:06 mode=040750 ouid=0 ogid=0 rdev=00:00
type=PATH msg=audit(1235030994.032:8649): item=0 name="/etc/audit" inode=368599
 dev=08:06 mode=040750 ouid=0 ogid=0 rdev=00:00
type=CWD msg=audit(1235030994.032:8649): cwd="/etc/audit"
type=SYSCALL msg=audit(1235030994.032:8649): arch=c000003e syscall=82 success=yes exit=0
 a0=7deeb0 a1=883b30 a2=2 a3=ffffffffffffffff items=4 ppid=25400 pid=32619 auid=0 uid=0
 gid=0 euid=0 suid=0 fsuid=0 egid=0 sgid=0 fsgid=0 tty=pts1 ses=1164 comm="vim" exe="/
 bin/vim-normal" key="CFG_audit.rules"
```

47 Useful resources

There are other resources available containing valuable information about the Linux audit framework:

The audit manual pages

There are several man pages installed along with the audit tools that provide valuable and detailed information:

[auditd\(8\)](#)

The Linux audit daemon

[auditd.conf\(5\)](#)

The Linux audit daemon configuration file

[auditctl\(8\)](#)

A utility to assist controlling the kernel's audit system

[autrace\(8\)](#)

A program similar to [strace](#)

[ausearch\(8\)](#)

A tool to query audit daemon logs

[aureport\(8\)](#)

A tool that produces summary reports of audit daemon logs

<https://people.redhat.com/sgrubb/audit/index.html> ↗

The home page of the Linux audit project. This site contains several specifications relating to different aspects of Linux audit, and a short FAQ.

[/usr/share/doc/packages/audit](#)

The audit package itself contains a README with basic design information and sample [.rules](#) files for different scenarios:

[capp.rules](#): Controlled Access Protection Profile (CAPP)

[lspp.rules](#): Labeled Security Protection Profile (LSPP)

[nispom.rules](#): National Industrial Security Program Operating Manual Chapter 8(NISPOM)

[stig.rules](#): Secure Technical Implementation Guide (STIG)

<https://www.commoncriteriaportal.org/> 

The official Web site of the Common Criteria project. Learn all about the Common Criteria security certification initiative and which role audit plays in this framework.

A GNU licenses

This appendix contains the GNU Free Documentation License version 1.2.

GNU Free Documentation License

Copyright (C) 2000, 2001, 2002 Free Software Foundation, Inc. 51 Franklin St, Fifth Floor, Boston, MA 02110-1301 USA. Everyone is permitted to copy and distribute verbatim copies of this license document, but changing it is not allowed.

0. PREAMBLE

The purpose of this License is to make a manual, textbook, or other functional and useful document "free" in the sense of freedom: to assure everyone the effective freedom to copy and redistribute it, with or without modifying it, either commercially or non-commercially. Secondly, this License preserves for the author and publisher a way to get credit for their work, while not being considered responsible for modifications made by others.

This License is a kind of "copyleft", which means that derivative works of the document must themselves be free in the same sense. It complements the GNU General Public License, which is a copyleft license designed for free software.

We have designed this License to use it for manuals for free software, because free software needs free documentation: a free program should come with manuals providing the same freedoms that the software does. But this License is not limited to software manuals; it can be used for any textual work, regardless of subject matter or whether it is published as a printed book. We recommend this License principally for works whose purpose is instruction or reference.

1. APPLICABILITY AND DEFINITIONS

This License applies to any manual or other work, in any medium, that contains a notice placed by the copyright holder saying it can be distributed under the terms of this License. Such a notice grants a world-wide, royalty-free license, unlimited in duration, to use that work under the conditions stated herein. The "Document", below, refers to any such manual or work. Any member of the public is a licensee, and is addressed as "you". You accept the license if you copy, modify or distribute the work in a way requiring permission under copyright law.

A "Modified Version" of the Document means any work containing the Document or a portion of it, either copied verbatim, or with modifications and/or translated into another language.

A "Secondary Section" is a named appendix or a front-matter section of the Document that deals exclusively with the relationship of the publishers or authors of the Document to the Document's overall subject (or to related matters) and contains nothing that could fall directly within that overall subject. (Thus, if the Document is in part a textbook of mathematics, a Secondary Section may not explain any mathematics.) The relationship could be a matter of historical connection with the subject or with related matters, or of legal, commercial, philosophical, ethical or political position regarding them.

The "Invariant Sections" are certain Secondary Sections whose titles are designated, as being those of Invariant Sections, in the notice that says that the Document is released under this License. If a section does not fit the above definition of Secondary then it is not allowed to be designated as Invariant. The Document may contain zero Invariant Sections. If the Document does not identify any Invariant Sections then there are none.

The "Cover Texts" are certain short passages of text that are listed, as Front-Cover Texts or Back-Cover Texts, in the notice that says that the Document is released under this License. A Front-Cover Text may be at most 5 words, and a Back-Cover Text may be at most 25 words.

A "Transparent" copy of the Document means a machine-readable copy, represented in a format whose specification is available to the general public, that is suitable for revising the document straightforwardly with generic text editors or (for images composed of pixels) generic paint programs or (for drawings) some widely available drawing editor, and that is suitable for input to text formatters or for automatic translation to a variety of formats suitable for input to text formatters. A copy made in an otherwise Transparent file format whose markup, or absence of markup, has been arranged to thwart or discourage subsequent modification by readers is not Transparent. An image format is not Transparent if used for any substantial amount of text. A copy that is not "Transparent" is called "Opaque".

Examples of suitable formats for Transparent copies include plain ASCII without markup, Texinfo input format, LaTeX input format, SGML or XML using a publicly available DTD, and standard-conforming simple HTML, PostScript or PDF designed for human modification. Examples of transparent image formats include PNG, XCF and JPG. Opaque formats include proprietary

formats that can be read and edited only by proprietary word processors, SGML or XML for which the DTD and/or processing tools are not generally available, and the machine-generated HTML, PostScript or PDF produced by some word processors for output purposes only.

The "Title Page" means, for a printed book, the title page itself, plus such following pages as are needed to hold, legibly, the material this License requires to appear in the title page. For works in formats which do not have any title page as such, "Title Page" means the text near the most prominent appearance of the work's title, preceding the beginning of the body of the text.

A section "Entitled XYZ" means a named subunit of the Document whose title either is precisely XYZ or contains XYZ in parentheses following text that translates XYZ in another language. (Here XYZ stands for a specific section name mentioned below, such as "Acknowledgements", "Dedications", "Endorsements", or "History".) To "Preserve the Title" of such a section when you modify the Document means that it remains a section "Entitled XYZ" according to this definition.

The Document may include Warranty Disclaimers next to the notice which states that this License applies to the Document. These Warranty Disclaimers are considered to be included by reference in this License, but only as regards disclaiming warranties: any other implication that these Warranty Disclaimers may have is void and has no effect on the meaning of this License.

2. VERBATIM COPYING

You may copy and distribute the Document in any medium, either commercially or non-commercially, provided that this License, the copyright notices, and the license notice saying this License applies to the Document are reproduced in all copies, and that you add no other conditions whatsoever to those of this License. You may not use technical measures to obstruct or control the reading or further copying of the copies you make or distribute. However, you may accept compensation in exchange for copies. If you distribute a large enough number of copies you must also follow the conditions in section 3.

You may also lend copies, under the same conditions stated above, and you may publicly display copies.

3. COPYING IN QUANTITY

If you publish printed copies (or copies in media that commonly have printed covers) of the Document, numbering more than 100, and the Document's license notice requires Cover Texts, you must enclose the copies in covers that carry, clearly and legibly, all these Cover Texts: Front-Cover Texts on the front cover, and Back-Cover Texts on the back cover. Both covers must also clearly and legibly identify you as the publisher of these copies. The front cover must present the full title with all words of the title equally prominent and visible. You may add other material on the covers in addition. Copying with changes limited to the covers, as long as they preserve the title of the Document and satisfy these conditions, can be treated as verbatim copying in other respects.

If the required texts for either cover are too voluminous to fit legibly, you should put the first ones listed (as many as fit reasonably) on the actual cover, and continue the rest onto adjacent pages.

If you publish or distribute Opaque copies of the Document numbering more than 100, you must either include a machine-readable Transparent copy along with each Opaque copy, or state in or with each Opaque copy a computer-network location from which the general network-using public has access to download using public-standard network protocols a complete Transparent copy of the Document, free of added material. If you use the latter option, you must take reasonably prudent steps, when you begin distribution of Opaque copies in quantity, to ensure that this Transparent copy will remain thus accessible at the stated location until at least one year after the last time you distribute an Opaque copy (directly or through your agents or retailers) of that edition to the public.

It is requested, but not required, that you contact the authors of the Document well before redistributing any large number of copies, to give them a chance to provide you with an updated version of the Document.

4. MODIFICATIONS

You may copy and distribute a Modified Version of the Document under the conditions of sections 2 and 3 above, provided that you release the Modified Version under precisely this License, with the Modified Version filling the role of the Document, thus licensing distribution and modification of the Modified Version to whoever possesses a copy of it. In addition, you must do these things in the Modified Version:

- A. Use in the Title Page (and on the covers, if any) a title distinct from that of the Document, and from those of previous versions (which should, if there were any, be listed in the History section of the Document). You may use the same title as a previous version if the original publisher of that version gives permission.
- B. List on the Title Page, as authors, one or more persons or entities responsible for authorship of the modifications in the Modified Version, together with at least five of the principal authors of the Document (all of its principal authors, if it has fewer than five), unless they release you from this requirement.
- C. State on the Title page the name of the publisher of the Modified Version, as the publisher.
- D. Preserve all the copyright notices of the Document.
- E. Add an appropriate copyright notice for your modifications adjacent to the other copyright notices.
- F. Include, immediately after the copyright notices, a license notice giving the public permission to use the Modified Version under the terms of this License, in the form shown in the Addendum below.
- G. Preserve in that license notice the full lists of Invariant Sections and required Cover Texts given in the Document's license notice.
- H. Include an unaltered copy of this License.
- I. Preserve the section Entitled "History", Preserve its Title, and add to it an item stating at least the title, year, new authors, and publisher of the Modified Version as given on the Title Page. If there is no section Entitled "History" in the Document, create one stating the title, year, authors, and publisher of the Document as given on its Title Page, then add an item describing the Modified Version as stated in the previous sentence.
- J. Preserve the network location, if any, given in the Document for public access to a Transparent copy of the Document, and likewise the network locations given in the Document for previous versions it was based on. These may be placed in the "History" section. You may omit a network location for a work that was published at least four years before the Document itself, or if the original publisher of the version it refers to gives permission.
- K. For any section Entitled "Acknowledgements" or "Dedications", Preserve the Title of the section, and preserve in the section all the substance and tone of each of the contributor acknowledgements and/or dedications given therein.
- L. Preserve all the Invariant Sections of the Document, unaltered in their text and in their titles. Section numbers or the equivalent are not considered part of the section titles.
- M. Delete any section Entitled "Endorsements". Such a section may not be included in the Modified Version.
- N. Do not retitle any existing section to be Entitled "Endorsements" or to conflict in title with any Invariant Section.
- O. Preserve any Warranty Disclaimers.

If the Modified Version includes new front-matter sections or appendices that qualify as Secondary Sections and contain no material copied from the Document, you may at your option designate some or all of these sections as invariant. To do this, add their titles to the list of Invariant Sections in the Modified Version's license notice. These titles must be distinct from any other section titles.

You may add a section Entitled "Endorsements", provided it contains nothing but endorsements of your Modified Version by various parties—for example, statements of peer review or that the text has been approved by an organization as the authoritative definition of a standard.

You may add a passage of up to five words as a Front-Cover Text, and a passage of up to 25 words as a Back-Cover Text, to the end of the list of Cover Texts in the Modified Version. Only one passage of Front-Cover Text and one of Back-Cover Text may be added by (or through arrangements made by) any one entity. If the Document already includes a cover text for the same cover, previously added by you or by arrangement made by the same entity you are acting on behalf of, you may not add another; but you may replace the old one, on explicit permission from the previous publisher that added the old one.

The author(s) and publisher(s) of the Document do not by this License give permission to use their names for publicity for or to assert or imply endorsement of any Modified Version.

5. COMBINING DOCUMENTS

You may combine the Document with other documents released under this License, under the terms defined in section 4 above for modified versions, provided that you include in the combination all of the Invariant Sections of all of the original documents, unmodified, and list them all as Invariant Sections of your combined work in its license notice, and that you preserve all their Warranty Disclaimers.

The combined work need only contain one copy of this License, and multiple identical Invariant Sections may be replaced with a single copy. If there are multiple Invariant Sections with the same name but different contents, make the title of each such section unique by adding at the end of it, in parentheses, the name of the original author or publisher of that section if known, or else a unique number. Make the same adjustment to the section titles in the list of Invariant Sections in the license notice of the combined work.

In the combination, you must combine any sections Entitled "History" in the various original documents, forming one section Entitled "History"; likewise combine any sections Entitled "Acknowledgements", and any sections Entitled "Dedications". You must delete all sections Entitled "Endorsements".

6. COLLECTIONS OF DOCUMENTS

You may make a collection consisting of the Document and other documents released under this License, and replace the individual copies of this License in the various documents with a single copy that is included in the collection, provided that you follow the rules of this License for verbatim copying of each of the documents in all other respects.

You may extract a single document from such a collection, and distribute it individually under this License, provided you insert a copy of this License into the extracted document, and follow this License in all other respects regarding verbatim copying of that document.

7. AGGREGATION WITH INDEPENDENT WORKS

A compilation of the Document or its derivatives with other separate and independent documents or works, in or on a volume of a storage or distribution medium, is called an "aggregate" if the copyright resulting from the compilation is not used to limit the legal rights of the compilation's users beyond what the individual works permit. When the Document is included in an aggregate, this License does not apply to the other works in the aggregate which are not themselves derivative works of the Document.

If the Cover Text requirement of section 3 is applicable to these copies of the Document, then if the Document is less than one half of the entire aggregate, the Document's Cover Texts may be placed on covers that bracket the Document within the aggregate, or the electronic equivalent of covers if the Document is in electronic form. Otherwise they must appear on printed covers that bracket the whole aggregate.

8. TRANSLATION

Translation is considered a kind of modification, so you may distribute translations of the Document under the terms of section 4. Replacing Invariant Sections with translations requires special permission from their copyright holders, but you may include translations of some or all Invariant Sections in addition to the original versions of these Invariant Sections. You may include a translation of this License, and all the license notices in the Document, and any Warranty Disclaimers, provided that you also include the original English version of this License and the original versions of those notices and disclaimers. In case of a disagreement between the translation and the original version of this License or a notice or disclaimer, the original version will prevail.

If a section in the Document is Entitled "Acknowledgements", "Dedications", or "History", the requirement (section 4) to Preserve its Title (section 1) will typically require changing the actual title.

9. TERMINATION

You may not copy, modify, sublicense, or distribute the Document except as expressly provided for under this License. Any other attempt to copy, modify, sublicense or distribute the Document is void, and will automatically terminate your rights under this License. However, parties who have received copies, or rights, from you under this License will not have their licenses terminated so long as such parties remain in full compliance.

10. FUTURE REVISIONS OF THIS LICENSE

The Free Software Foundation may publish new, revised versions of the GNU Free Documentation License from time to time. Such new versions will be similar in spirit to the present version, but may differ in detail to address new problems or concerns. See <https://www.gnu.org/copyleft/>.

Each version of the License is given a distinguishing version number. If the Document specifies that a particular numbered version of this License "or any later version" applies to it, you have the option of following the terms and conditions either of that specified version or of any later version that has been published (not as a draft) by the Free Software Foundation. If the Document does not specify a version number of this License, you may choose any version ever published (not as a draft) by the Free Software Foundation.

ADDENDUM: How to use this License for your documents

```
Copyright (c) YEAR YOUR NAME.
Permission is granted to copy, distribute and/or modify this document
under the terms of the GNU Free Documentation License, Version 1.2
or any later version published by the Free Software Foundation;
with no Invariant Sections, no Front-Cover Texts, and no Back-Cover Texts.
A copy of the license is included in the section entitled "GNU
Free Documentation License".
```

If you have Invariant Sections, Front-Cover Texts and Back-Cover Texts, replace the "with...Texts." line with this:

```
with the Invariant Sections being LIST THEIR TITLES, with the
Front-Cover Texts being LIST, and with the Back-Cover Texts being LIST.
```

If you have Invariant Sections without Cover Texts, or some other combination of the three, merge those two alternatives to suit the situation.

If your document contains nontrivial examples of program code, we recommend releasing these examples in parallel under your choice of free software license, such as the GNU General Public License, to permit their use in free software.